



Manfrotto Video Supports

 **Manfrotto**
Imagine More

manfrotto.com



Manfrotto Video Supports



Technological evolution is profoundly changing videography and its workflow.

Camcorder performance continues to improve while camcorders shrink in size and become more affordable. In parallel, the latest HD SLRs combine top quality video with proven photographic capabilities. As a result, an increasing number of new users are picking up cameras, joining our world and producing fantastic results. HD SLR cameras and the latest interchangeable lens camcorders are also bringing about new demands in terms of support and accessory equipment: Manfrotto Video Products are answering these demands. Manfrotto has started offering new electronic devices to make the videographer's job easier, supporting him with traditional support systems that are all backed up by a complete range of accessories: from video camera

and HD SLR remote controls to bags and carrying solutions. These are exciting times for Manfrotto: the increasing fusion of video and photo equipment and user crossover between the two worlds let us apply our experience, knowledge and leadership from the photographic sector to videography to an even greater extent. Collaborating with some of the greatest names in film and video, we're developing well-designed, high-performance, top-quality innovative products that meet and exceed the expectations of our most demanding expert users and also help set the pace of technological evolution.

We hope you find the catalogue inspiring and useful. For all the news that's still too new to print, please visit www.manfrotto.com

Contents	4	HEADS
	18	TRIPODS
	28	MONOPODS
	30	SYMPLA FIG RIG SYSTEM
	36	DIGITAL DIRECTOR
	38	REMOTE CONTROLS
	46	ALTERNATIVE SUPPORTS
	50	ACCESSORIES
	56	BAGS AND STRAPS
	60	INDEX

To understand the icons, consult the key to symbols on the back page.





HEADS

BRIDGING TECHNOLOGY™

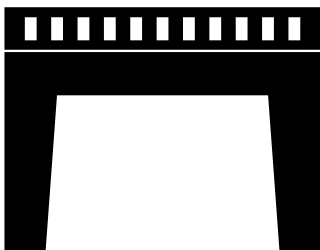

Video technology has changed radically in recent years, with a quick succession of ever lighter, more compact cameras launched. These cameras have in turn led to new ways of filming, allowing one-man units to produce results that only a few short years ago would have required a full crew.

Video is moving to a new dimension, Bridging Technology™ heads help you cross over!

The Bridging Technology™ range is a key element in Manfrotto's response to these changes in the video sector. The ergonomic and technical characteristics of our Bridging Technology™ series are the result of our expertise in producing lightweight camera supports. The extended range offers ideal support across the full spectrum of "new" video cameras, providing a perfect match for the latest camcorders, HD SLRs and even 3D rigs, with each individual head designed and engineered to help videographers get the best possible results from HD camera equipment.



Bridging Technology™: an exclusive Manfrotto patent.

The perfect synthesis of an innovative “bridge” structure and cutting-edge engineering.

Real fluid cartridges, longer sliding plates and inner ball-bearings ensure that all our Bridging Technology™ heads provide smoother shooting, better balance and more precise movement.

Suitable for a wide range of cameras, Bridging Technology™ heads have maximum loads between 5kg and 12kg, and are also available in combination with a variety of aluminum or carbon fiber twin- or single-tube tripods.





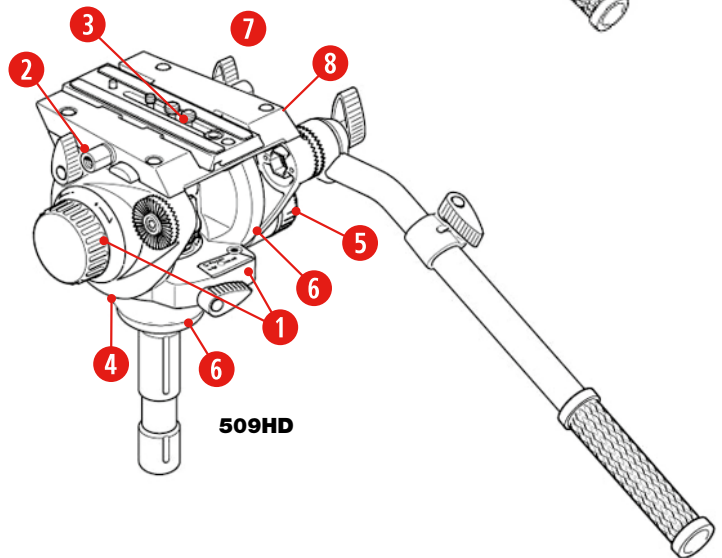
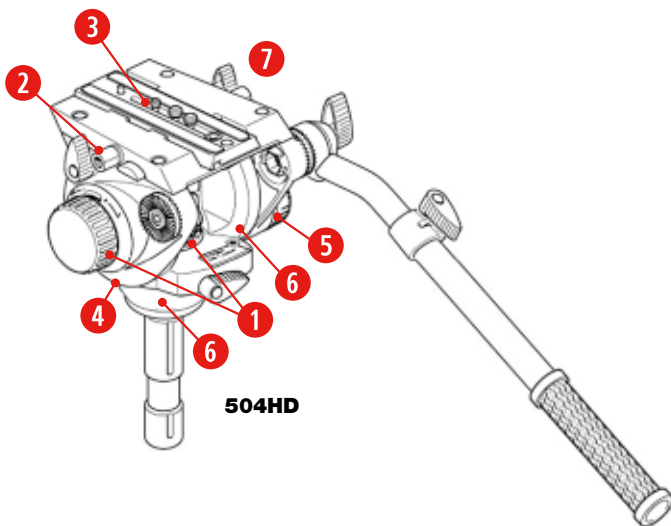
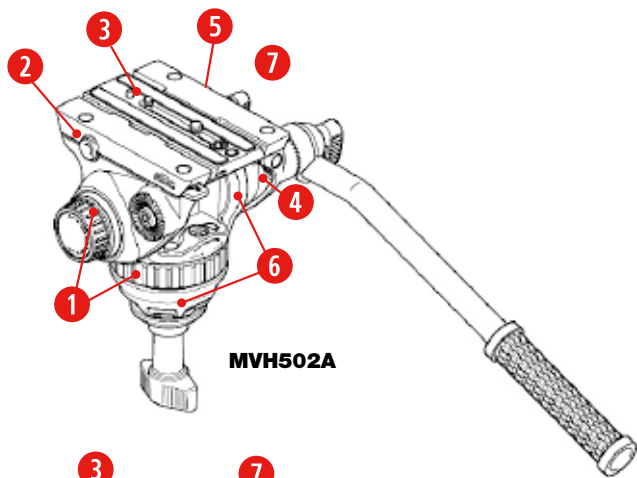
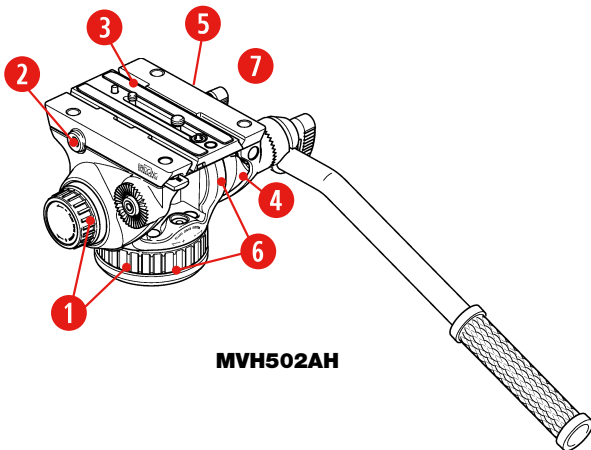
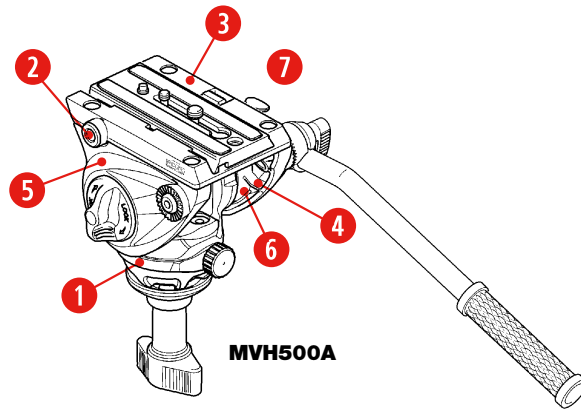
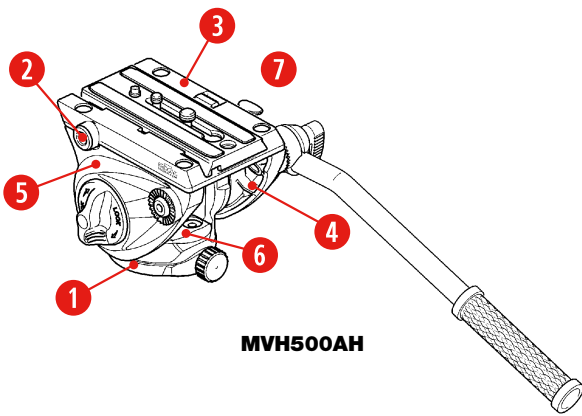







Unique features for unique footage



- 1 Fluid cartridges for smooth movement and precise control
- 2 3/8" Easy Link connector to support external accessories
- 3 Wider platform for HD/SLR bodies and the sliding plate travel to balance the latest cameras with interchangeable lenses
- 4 An even more rigid structure for maximum precision and improved responsiveness
- 5 Counterbalance system ensures quick set-up and optimal performance
- 6 Ball bearings for more precise, smooth movements
- 7 Lightweight modern materials for optimum balance of strength and size
- 8 ABR (Advanced Balancing Recorder) for precision when fixing equipment, ensuring a perfect position, saving time and making this operation much more efficient, accurate and fast



		MVH500AH	MVH500A	MVH502AH	MVH502A	504HD	509HD
	Fluidity PAN & TILT	Fixed Cartridges	Fixed Cartridges	Variable Fluid Cartridges	Variable Fluid Cartridges	Variable Fluid Cartridges	Variable Fluid Cartridges
	Counter-balance System	Fixed	Fixed	Fixed	Fixed	4 steps	4 steps
	Flat base	Flat base with 3/8" female attachment		Flat base with 3/8" female attachment			
	Leveling bowl		Ø 60mm		Ø 75mm	Ø 75mm	Ø 100mm
	ABR (Advanced Balancing Recorder)	N.A.	N.A.	N.A.	N.A.	N.A.	Available
	Counter-balance weight	2,4kg - 5.3lb	2,4kg - 5.3lb	4kg - 8.8lb	4kg - 8.8lb	7,5kg - 16.5lb	12,8kg - 28.1lb (@55 C.O.G.) 8,5kg - 18.7lb (@125 C.O.G.)
	Safety payload	5kg - 11lb	5kg - 11lb	7kg - 15.4lb	7kg - 15.4lb	12kg - 26.5lb	13,5kg - 29.8lb (@55 C.O.G.) 9kg - 19.8lb (@125 C.O.G.)
	Center of gravity	55	55	55	55	55	55 - 125
	Weight	0,9kg - 2.2lb	1,1kg - 2.4lb	1,7kg - 3.7lb	1,9kg - 4.2lb	2,9kg - 6.4lb	3,9kg - 8.6lb
	Head height	10,5cm - 4.1in	12,6cm - 5in	13cm - 5.1in	15cm - 5.9in	15,5cm - 6in	18cm - 7.1in
	Sliding plate	500PLONG	500PLONG	504PLONG	504PLONG	504PLONG	509PLONG
		(120mm - 4.7in)	(120mm - 4.7in)	(140mm - 5.5in)	(140mm - 5.5in)	(140mm - 5.5in)	(140mm - 5.5in)
	Easy Link connectors	Available x 1	Available x 1	Available x 2	Available x 2	Available x 2	Available x 2
	Leveling bubble	Available	Available	Available	Available	Available (illuminated)	Available (illuminated)



MVH500A

MVH500AH



MVH500A FLUID VIDEO HEAD - 60MM HALF BALL

The new 500, which replaces the 701HDV, is a lightweight video head featuring a wider platform to accommodate both HD/SLR and interchangeable lens camcorder, as well as a sliding plate that ensures the appropriate balance even when shooting with very long lenses. The 500, the entry level of the Bridging Technology™ series, ensures smooth shots and fine control of up to 5kg of equipment. Its brand new side lock allows fast, secure and easy camera attachment. It has one Easy Link 3/8" connector to allow an external monitor or other accessory equipment to be fitted. The MVH500A has a 60mm half ball video tripod mount.



MVH500AH FLUID VIDEO HEAD - FLAT BASE

Same characteristics as the MVH500A, but with a flat base mount with standard 3/8" thread. Ideal for tripod/slider/rig/crane application.



COUNTERBALANCE GRAPH

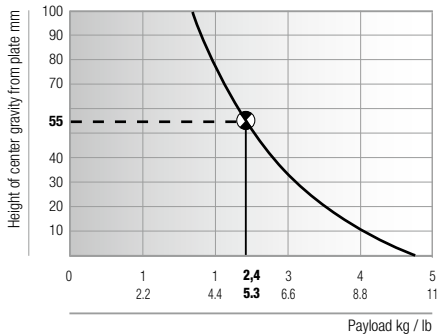

- 1 Locking knobs
- 2 CBS: Counterbalance System
- 3 Leveling bubble



- 1 FDS: Fluid Drag System
- 2 Locking knobs
- 3 Wider platform + longer sliding plate
- 4 Easy Link - 3/8" thread connection



- 1 FDS: Fluid Drag System
- 2 Side lock lever



TECHNICAL SPECIFICATIONS

Head base	60mm half ball (MVH500A) - Flat (MVH500AH)
Pan drag type	Fixed fluid cartridge
Tilt drag type	Fixed fluid cartridge
Counterbalance weight	Fixed @ 2,4kg (5.3lb)
Safety payload	5kg (11lb)
Leveling bubble	Available
Pan bar	Available

Pan bar attachment	Available on right and left sides
Replaceable pan bar rosette	No
Plate type	500PLONG Quick Release with Side Lock
Plate travel	100mm (3.9in)
Plate attachment	3/8" and 1/4" camera screws + anti-rotation pin
Pan range	360°
Tilt range	-70° +90°
Temperature range	-20° C +60° C



MVM500A
FLUID MONOPOD WITH 500 HEAD

2,4kg 5.3lb	5kg 11lb	77cm 30.3in	200.5cm 78.9in	2,8kg 6.2 lb	500PLONG



MVH500AH, 755XBK SYSTEM

2,4kg 5.3lb	5kg 11lb	73cm 28.7in	51cm 20.1in	149.5cm 58.9in	174cm 68.5in	174cm 68.5in	3,4kg 7.5lb

Head MVH500AH
Tripod Aluminum 755XB
Bag included



MVH500AH, 755CX3 SYSTEM

2,4kg 5.3lb	5kg 11lb	73cm 28.7in	56cm 21.8in	148cm 58.2in	173cm 68.1in	173cm 68.1in	3kg 6.5lb

Head MVH500AH
Tripod Carbon Fiber 755CX3
Bag included



MVK500AM SYSTEM

2,4kg 5.3lb	5kg 11lb	72cm 28.3in	67.5cm 26.3in	154cm 60.3in	3,1kg 6.8lb

Head MVH500A
Tripod Aluminum MVT502AM
Mid spreader included
Bag included



MVK500AQ SYSTEM

2,4kg 5.3lb	5kg 11lb	72cm 28.3in	35cm 13.8in	177cm 69.7in	5,1kg 11.2lb

Head MVH500AH
Tripod Aluminum MVT535AQ
Bag included



MVK500C SYSTEM

2,4kg 5.3lb	5kg 11lb	85cm 33.5in	38.5cm 15.2in	182.5cm 71.8in	3,4kg 7.5lb

Head MVH500A
Tripod Carbon Fiber 535
Bag included



MVH502A FLUID VIDEO HEAD - 75MM HALF BALL

The 502 fluid head is designed for use with HD/SLR cameras and latest interchangeable lens cameras. It offers professional features such as high-performance variable fluidity and a counterbalance system. The 502 supports up to 7kg cameras and accessories, with a counterbalance setting designed to match the weight of the most popular cameras and their accessories as external monitors, lights or microphones. The 502's Easy Link attachment points mean that the weight of accessories can be supported directly by the head, rather than by the camera. The MVH502A has a 75mm half ball video tripod mount.



MVH502AH FLUID VIDEO HEAD - FLAT BASE

Same characteristics as the MVH502A, but with a flat base mount with standard 3/8" thread. Ideal for tripod/slider/rig/crane application.



COUNTERBALANCE GRAPH

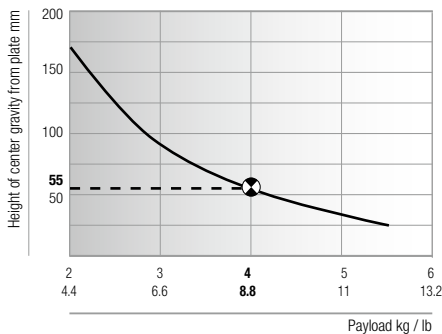

- 1 Sliding plate safety release button
- 2 Pan drag control
- 3 Leveling bubble



- 1 Pan locking knob
- 2 Tilt drag control
- 3 Easy link connectors



- 1 Tilt locking knob
- 2 Sliding quick release plate
- 3 Sliding quick release knob
- 4 Easy link connectors



TECHNICAL SPECIFICATIONS

Head base	75mm half ball (MVH502A) - Flat (MVH502AH)
Pan drag type	Fixed fluid cartridge (from 0 to max level)
Tilt drag type	Fixed fluid cartridge (from 0 to max level)
Counterbalance weight	Fixed @ 4kg (8.8lb)
Safety payload	7kg (15.4lb)
Leveling bubble	Available
Pan bar	Available

Pan bar attachment	Available on right and left sides
Replaceable pan bar rosette	No
Plate type	504PLONG Quick Release
Plate travel	83mm (3.3in)
Plate attachment	3/8" and 1/4" camera screws + anti-rotation pin
Pan range	360°
Tilt range	-80° +90°
Temperature range	-20° C +60° C



MVK502C-1 SYSTEM

4kg 8.8lb	7kg 15.4lb	87,5cm 34.5in	41cm 16.1in	185cm 72.8in	4,3kg 9.5lb

Head MVH502A
Tripod Carbon Fiber 535
Bag included



MVK502AQ SYSTEM

4kg 8.8lb	7kg 15.4lb	73,4cm 28.9in	37cm 14.6in	179cm 70.5in	5,9kg 13lb

Head MVH502A
Tripod Aluminum MVT535AQ
Bag included



MVK502AM-1 SYSTEM

4kg 8.8lb	7kg 15.4lb	75cm 29.5in	70,5cm 27.8in	156cm 61.4in	3,8kg 8.4lb

Head MVH502A
Tripod Aluminum MVT502AM
Mid spreader included
Bag included



MVH502A, 546BK-1 SYSTEM

4kg 8.8lb	7kg 15.4lb	83cm 32.7in	41cm 16.1in	164,5cm 64.8in	5,5kg 12.1lb

Head MVH502A
Tripod Aluminum 546B
Mid spreader included
Bag included



MVH502A, 546GB-1 SYSTEM

4kg 8.8lb	7kg 15.4lb	83cm 32.7in	44cm 17.3in	168cm 66.1in	5,5kg 12.1lb

Head MVH502A
Tripod Aluminum 546GB
Spreader included
Bag included



504HD FLUID VIDEO HEAD - 75MM HALF BALL

The compact 504HD combines high-performance variable fluidity with a wide variety of professional features, including a 4-step counterbalance system, ergonomic positioning of all knobs for tilt, drag and locking on the left side of the head, illuminated leveling bubble and replaceable pan-bar rosettes. The 504HD designed to support the latest generation of HD cameras weighing up to 12kg (26.5lb) and counterbalancing up to 7.5kg (16.5lb). The 504HD has a 75mm half ball video tripod mount.

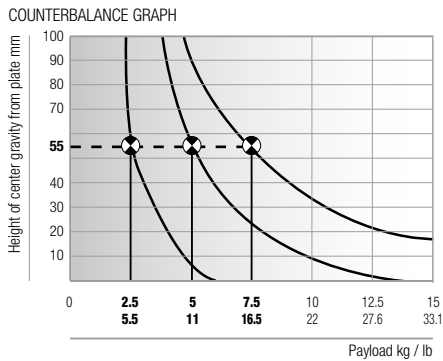

- 1 Pan drag control
- 2 Pan locking knob
- 3 Illuminated leveling bubble



- 1 Tilt locking knob
- 2 Tilt drag knob
- 3 Sliding plate safety release button
- 4 Easy Link - 3/8" thread connection



- 1 Counterbalance adjustment knob
- 2 Sliding quick release plate
- 3 Sliding quick release knob



TECHNICAL SPECIFICATIONS

Head base	75mm half ball	Pan bar attachment	Available on right and left sides
Pan drag type	Fixed fluid cartridge (from 0 to max level)	Replaceable pan bar rosette	Yes, on both sides
Tilt drag type	Fixed fluid cartridge (from 0 to max level)	Plate type	504PLONG Quick Release
Counterbalance system	Variable 4 steps	Plate travel	83mm (3.3in)
Counterbalance weight	0 - 2,5 - 5 - 7,5kg (0 - 5.5 - 11 - 16.5lb)	Plate attachment	3/8" and 1/4" camera screws + anti-rotation pin
Safety payload	12kg (26.5lb)	Pan range	360°
Leveling bubble	Available (illuminated with led)	Tilt range	-60° +90°
Pan bar	Available (telescopic)	Temperature range	-20° C +60° C



504HD, 536K SYSTEM

7,5kg 16.5lb	12kg 26.5lb	85,5cm 33.6in	40cm 15.7in	217,5cm 85.6in	6,1kg 13.5b

Head 504HD
Tripod Carbon Fiber 536
Bag MB MBAG100PN



MVK504AQ SYSTEM

7,5kg 16.5lb	12kg 26.5lb	73cm 28.7in	36,5cm 14.4in	179cm 70.5in	6,6kg 14.5lb

Head 504HD
Tripod Aluminum MVT535AQ
Bag MB MBAG80PN



504HD, 535K SYSTEM

7,5kg 16.5lb	12kg 26.5lb	88cm 34.6in	40,5cm 15.9in	184cm 72.4in	5kg 11lb

Head 504HD
Tripod Carbon Fiber 535
Bag MB MBAG100PN



504HD, 546BK SYSTEM

7,5kg 16.5lb	12kg 26.5lb	84cm 33.1in	44cm 17.3in	167,5cm 65.9in	6,3kg 13.9lb

Head 504HD
Tripod Aluminum 546B
Mid spreader included
Bag MB MBAG100PN



504HD, 546GBK SYSTEM

7,5kg 16.5lb	12kg 26.5lb	84cm 33.1in	46,5cm 18.3in	171cm 67.3in	6,3kg 13.9lb

Head 504HD
Tripod Aluminum 546GB
Spreader included
Bag MB MBAG100PN



509HD PRO FLUID VIDEO HEAD - 100MM HALF BALL

The 509HD fluid head combines ergonomic design features with professional performance. To help you obtain incredibly smooth camera movements and great footage, the 509HD has variable fluid drag and a fast, precise, 4-step counterbalance system that makes it suitable for a wide range of semi-professional and professional camera setups. The 509HD's patented Advanced Balancing Recorder (ABR) allows you to quickly find, store and recuperate the correct balance position of the plate when using a particular combination of equipment. The 509HD also features Easy Link connectors for accessory attachment, an illuminated leveling bubble and replaceable rosettes for pan bar attachment on both sides of the head. The 509HD has a 100mm half ball video tripod mount.

12,8kg - 28,2lb (@ 55 C.O.G.) 8,5kg - 18,7lb (@ 125 C.O.G.)	13,5kg - 29,8lb (@ 55 C.O.G.) 9kg - 19,8lb (@ 125 C.O.G.)	18cm 7.1in	3,9kg 8.6lb	509PLONG

COUNTERBALANCE GRAPH

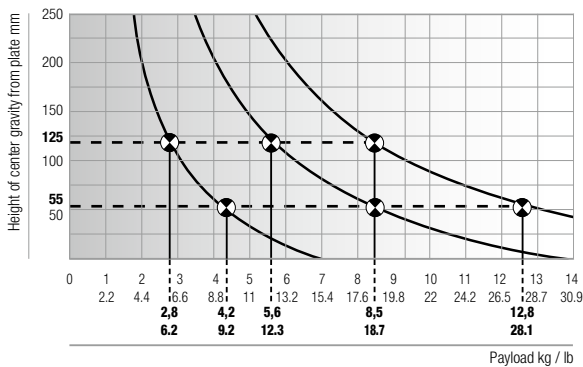

- 1 Pan drag control
- 2 Pan locking knob
- 3 Illuminated leveling bubble



- 1 Tilt locking knob
- 2 Tilt drag knob
- 3 Sliding plate safety release button



- 1 Counterbalance adjustment knob
- 2 Sliding quick release plate
- 3 Sliding quick release knob
- 4 Advanced Balancing Recorder
- 5 Easy Link - 3/8" thread connection









TECHNICAL SPECIFICATIONS

Head base	100mm half ball	Pan bar	Available (telescopic)
Pan drag type	Fixed fluid cartridge (from 0 to max level)	Pan bar attachment	Available on right and left sides
Tilt drag type	Fixed fluid cartridge (from 0 to max level)	Replaceable pan bar rosette	Yes, on both sides
Counterbalance system	Variable 4 steps	Plate type	509PLONG Quick Release with ABR
Counterbalance weight	0 - 4.2 - 8.5 - 12.8kg (0 - 9.2 - 18.7 - 28.1lb) @ 55 C.O.G. 0 - 2.8 - 5.6 - 8.5kg (0 - 6.2 - 12.3 - 18.7lb) @ 125 C.O.G.	Plate travel	83mm (3.3in)
Safety payload	13.5kg (29.8lb) @ 55 C.O.G. 9kg (19.8lb) @ 125 C.O.G.	Plate attachment	3/8" and 1/4" camera screws + anti-rotation pin
Leveling bubble	Available (illuminated with led)	Pan range	360°
		Tilt range	-60° +90°
		Temperature range	-20° C +60° C









509HD, 536K SYSTEM

					
12,8kg - 28.2lb (@ 55 c.o.g.) 8,5kg - 18.7lb (@ 125 c.o.g.)	13,5kg - 29.8lb (@ 55 c.o.g.) 9kg - 19.8lb (@ 125 c.o.g.)	87cm 34.2in	40,5cm 15.9in	217,5cm 85.6in	7,1kg 15.7lb

Head 509HD
Tripod Carbon Fiber 536
Bag MB MBAG100PNHD









509HD, 545BK SYSTEM

					
12,8kg - 28.2lb (@ 55 c.o.g.) 8,5kg - 18.7lb (@ 125 c.o.g.)	13,5kg - 29.8lb (@ 55 c.o.g.) 9kg - 19.8lb (@ 125 c.o.g.)	84cm 33.1in	44,5cm 17.5in	168,5cm 66.3in	7,3kg 16.1lb

Head 509HD
Tripod Aluminum 545B
Mid spreader included
Bag MB MBAG100PNHD



509HD, 545GBK SYSTEM

					
12,8kg - 28.2lb (@ 55 c.o.g.) 8,5kg - 18.7lb (@ 125 c.o.g.)	13,5kg - 29.8lb (@ 55 c.o.g.) 9kg - 19.8lb (@ 125 c.o.g.)	84cm 33.1in	48cm 18.9in	172cm 67.7in	7,3kg 16.1lb

Head 509HD
Tripod Aluminum 545GB
Spreader included
Bag MB MBAG100PNHD



526 PRO FLUID VIDEO HEAD - 100MM HALF BALL

The 526 is a professional, heavy duty, fluid head aimed at high-end ENG and EFP, with a feature set designed to allow cameramen to work quickly and easily under pressure. For example, the 526's large control knobs for tilt/pan lock and tilt drag are all located on the left side of the head for single-handed adjustment, and all the controls are rubber-padded for better grip. The 526 has a very precise fluid drag system with three drag level settings (low, medium and high, numbered 1, 2 and 3 respectively). Drag setting 0 switches off the drag for snap-pans/tilts. Counterbalance is via a continuously adjustable spring for different camera weights.



15g
33.1lb



16kg
35.3lb



15cm
5.9in



3.6kg
7.9lb



357PLV

COUNTERBALANCE GRAPH

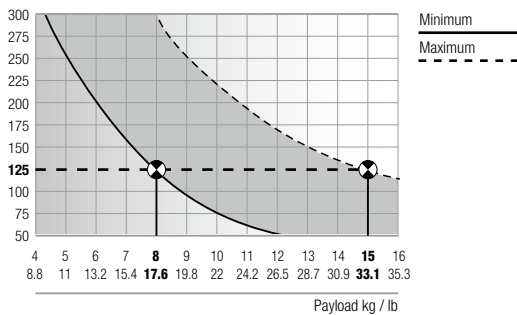

- 1 Pan locking knob
- 2 Pan drag control
- 3 Leveling bubble



- 1 Tilt locking knob
- 2 Tilt drag knob
- 3 Counterbalance adjustment knob



- 1 Sliding plate safety release button
- 2 Sliding quick release plate
- 3 Sliding quick release knob
- 4 Interchangeable pan bar rosette









TECHNICAL SPECIFICATIONS

Head base	100mm half ball	Pan bar attachment	Available on right and left sides
Pan drag type	0 plus - 3 steps	Replaceable pan bar rosette	Yes, on both sides
Tilt drag type	0 plus - 3 steps	Plate type	357PLV
Counterbalance system	Variable continuous	Plate travel	80mm (3.1in)
Counterbalance weight	8 - 15kg (17.6 - 33.1lb)	Plate attachment	3/8" and 1/4" camera screws + anti-rotation pin
Safety payload	16kg (35.3lb)	Pan range	360°
Leveling bubble	Available	Tilt range	-70° +75°
Pan bar	Available (telescopic)	Temperature range	-20° C +60° C









526, 536K SYSTEM

					
15kg 33.1lb	16kg 35.3lb	86cm 33.9in	43cm 16.9in	218cm 85.1in	6,9kg 15.2lb

Head 526
Tripod Carbon Fiber 536
Bag MB MBAG100PN









526, 545BK SYSTEM

					
15kg 33.1lb	16kg 35.3lb	84cm 33.1in	45cm 17.7in	169cm 66.5in	7,1kg 15.7lb

Head 526
Tripod Aluminum 545B
Mid spreader included
Bag MB MBAG100PN









526, 545GBK SYSTEM

					
15kg 33.1lb	16kg 35.3lb	84cm 33.1in	47,5cm 18.7in	173cm 68.1in	7,1kg 15.7lb

Head 526
Tripod Aluminum 545GB
Spreader included
Bag MB MBAG100PN



526, 528XBK SYSTEM

					
15kg 33.1lb	16kg 35.3lb	114cm 44.9in	88cm 34.6in	163cm 64.2in	11kg 24.3lb

Head 526
Tripod Aluminum / Steel 528XB
Mid spreader included
Bag MB MBAG120PN



TRIPODS

The Manfrotto video tripod range covers a wide variety of applications and user needs, offering both twin-leg and single-leg tripods, with traditional video half-bowl or flat-base head attachments, as well as hybrid video/photo innovations like the MDeVe leveling column. Our tripods are assembled from high-performance components made in carefully chosen raw materials such as carbon fiber, aluminum, magnesium and high-quality technopolymers. When choosing the right tripod, key factors to take into account include the camera setup you need to support and the video head you'll be matching with the tripod, the specific application and environment in which your kit will be used, and characteristics such as compactness, extended height, weight and leg angle settings.

MDeVe tripods are where Manfrotto's video know-how and our long experience in photography meet: our R&D team realized that video supports could benefit from some of the main advantages of photo tripods. They took the lightweight, torsion-resistant, single carbon/aluminum tube leg structure of the photo tripod, with its easily extensible center column, and built a new video-ready 50mm half ball leveling system at the top of the center column. Locked and unlocked via the (detachable) rotating grip at the bottom of the column, the MDeVe system allows the operator to level the camera without needing to make micro adjustments to each individual tripod leg.

The result is a tripod that's as quick to set up as a true photo tripod, but has the fine leveling and torsion resistance demanded by video. MDeVe tripods are ideally suited to use with lightweight camera equipment and in situations where set-up speed is of the essence.



Center column with built-in 50mm half ball locked using the rotating grip located at the bottom of the center column. Tilt range: $+15^{\circ}/-15^{\circ}$.



Single tube leg profile made of round-section aluminum or carbon fiber.



Four different leg angle settings.



Quick action lever leg lock system (45° run).



Rubber feet.



755CX3 MDEVE MAGFIBER VIDEO TRIPOD

Two-stage tripod with a perfect combination of low weight and high load capacity that comes from the use of carbon fiber and magnesium in its construction.

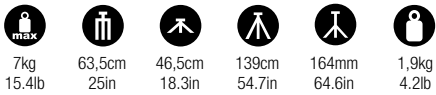

TECHNICAL SPECIFICATIONS 755CX3

Head attachment	50mm leveling flat base with 3/8" screw + extendible center column
Leveling bubble	Yes
Locking type	Lever locks
Leg angle setting	By leg selector
Leg angle	4 steps (23° - 47° - 66° - 89°)
Included spike foot shoes	No



755XB MDEVE ALUMINUM VIDEO TRIPOD

Designed to withstand rugged use and to support professional lightweight camcorders, the 755XB is an extremely versatile tripod. Entirely made from aluminum.

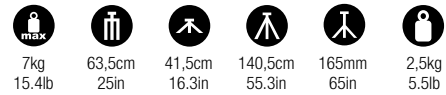

TECHNICAL SPECIFICATIONS 755XB

Head attachment	50mm leveling flat base with 3/8" screw + extendible center column
Leveling bubble	Yes
Locking type	Lever locks
Leg angle setting	By leg selector
Leg angle	4 steps (23° - 45° - 65° - 88°)
Included spike foot shoes	No



MPRO tripods combine performance and functionality. With torsion rigidity that's superior to that of an equivalent aluminum twin-strut tripod, the MPRO tripods offer better protection against 'backlash' effects at the end of pan movements. They are available in both aluminum and carbon fiber. The MPRO tripods offer incredibly versatile and speedy height adjustment anywhere, without needing any accessories.



75mm bowl (535 version only).



75/100mm screw-in adaptor (536 version only) to hold the different industry standard half-ball heads.



High-performance Carbon fiber tubes. Lightweight and resistant magnesium die castings.



Ergonomic leg angle selector for a quick, easy and precise angle adjustment.



Quick action ergonomic leg locks.



Retractable spiked feet for in and outdoor use.



MVT535AQ MPRO ALU 3-STAGE VIDEO TRIPOD

The MVT535AQ aluminum single leg tripod features 4 Sections and a 75mm half bowl. It also includes the MVA060T adapter, which converts the 75mm into a 60mm half bowl. It is a sturdy, reliable solution that is compact and easy to use. In addition, the leg angle selector enables users to adjust operating height as needed.

20kg 44.1lb	60cm 23.6in	22,8cm 9in	165cm 65in	3,3kg 7.2lb

TECHNICAL SPECIFICATIONS MVT535AQ

Head attachment	75mm bowl + 60mm adapter
Leveling bubble	No
Locking type	Lever locks
Leg angle setting	By leg selector
Leg angle	3 steps (23° - 50° - 70°)
Included spike foot shoes	No



535 MPRO CARBON FIBER 2-STAGE VIDEO TRIPOD

The 3-section, single-tube 535 video tripod offers great stability, high load capacity and a very useful maximum height. Ergonomic, easy-to-use and compact, it has a 75mm half bowl for compatibility with mid-range video heads. Leg tubes are in carbon fiber, while die castings are in magnesium to keep weight low and performance high. In addition, the 535 has a new leg angle selector, developed for quick, easy and precise independent leg angle adjustments.

20kg 44.1lb	73,5cm 28.9in	27cm 10.6in	171cm 67.3in	2,3kg 5.1lb

TECHNICAL SPECIFICATIONS 535

Head attachment	75mm bowl
Leveling bubble	No
Locking type	Lever locks
Leg angle setting	By leg selector
Leg angle	3 steps (23° - 50° - 70°)
Included spike foot shoes	No

536 MPRO CARBON FIBER 3-STAGE VIDEO TRIPOD

The 4-section, single tube 536 video tripod is incredibly stable, even though it offers a very high load capacity and a very tall maximum height. Despite its open height, it's compact when folded. The single tube structure makes it light in weight, ergonomic and easy-to-use. Features our new leg angle selector, developed for quick, easy and precise independent leg angle adjustments. The half-bowl attachment fits industry-standard 75mm or 100mm half ball heads; an adaptor is supplied to switch between the two sizes.

25kg 55.1lb	72cm 28.3in	26cm 10.2in	203cm 79.9in	3,3kg 7.3lb

TECHNICAL SPECIFICATIONS 536

Head attachment	100mm bowl + 75mm adapter
Leveling bubble	No
Locking type	Lever locks
Leg angle setting	By leg selector
Leg angle	3 steps (23° - 50° - 70°)
Included spike foot shoes	No

TELESCOPIC TWIN LEG SYSTEMS The new MVT502AM is a lightweight video tripod built with innovative telescopic twin elliptic tube legs. The two-stage structure makes the tripod more compact and more stable. As a result, the MVT502AM is a perfect solution for those looking for a tripod that offers transportability without sacrificing performance.



Made of elliptic aluminum tubes, our new telescopic leg is the product of extensive research into lightweight applications; it allows the tripod to be extra stable.



New innovative design reduces the weight of the system without any loss in performance.



The two-stage telescopic legs reduce the size of the tripod when folded.



For easier and safer transportation.



Thanks to the improved clamping mechanism, the new higher spreader allows the tripod to be set up faster and easier.



The 75mm bowl guarantees the perfect position can be achieved at any angle between -15° and $+15^\circ$.



New leg locking system with ergonomic levers enables the easy locking of the elliptic telescopic tubing in any position.



MVT502AM TELESCOPIC-TWIN LEG TRIPOD

The MVT502AM is a two-stage tripod for lightweight applications. Its telescopic-twin legs are made of elliptical aluminum tubes that help reduce torsion and give the tripod a good balance of high performance and reduced weight. Other features include a fixed mid-level spreader for increased rigidity and faster set-up, a rubber strap for safer, easier transportation, and new high-grip soft rubber feet. The MVT502AM's 75mm half-bowl matches mid-range Manfrotto video heads.



15kg
33.1lb



61,5cm
24.2in



57cm
22.4in



143,5cm
56.5in



1,95kg
4.3lb

TECHNICAL SPECIFICATIONS MVT502AM

Head attachment	75mm bowl + 60mm adapter	Included mid spreader	Yes
Leveling bubble	No	Included ground spreader	No
Locking type	Lever locks	Included spike foot shoes	No
Leg angle setting	Not setting		
Leg angle	19°		

The **PRO** series fits neatly into the PRO range of video tripods: it has an aluminum top casting allowing it to be used with our professional half-ball video heads with Ø 100mm or 75mm fittings; its aluminum twin-strut legs feature adjustable locking levers that can be tension-set to guarantee complete locking power even after years of use and wear; the spiked feet with removable rubber shoes are suitable for any surface from smooth, delicate floors to uneven ground.



Built-in half bowl (Ø 100mm or 75mm)



Mid or ground spreader for improved tripod stability.



Spreader length regulation.

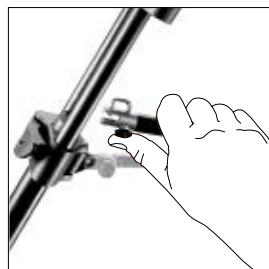

New spreader attachment.



Rubber shoes guarantee a better grip on smooth floors.



Newly redesigned collars, integrated in the overall product ergonomics for improved rigidity.



545B PRO HEAVY-DUTY VIDEO TRIPOD

Two-stage, extremely rigid, professional video tripod. Able to carry loads up to 25kg (55.1lb). The 545B has a die cast aluminum crown with a 100mm half-bowl (code 319 is available as accessory to convert it to 75mm). The 545's leg locks are secure and reliable, and spiked feet with rubber overshoes are provided for solid grounding on both uneven terrain and smooth floors. The tripod can be used with various dollies. The 545B has a telescopic mid-level spreader to help set leg angles accurately.

25kg 55.1lb	69cm 27.2in	30cm 11.8in	154cm 60.3in	3.5kg 7.7lb

TECHNICAL SPECIFICATIONS 545B

Head attachment	100mm bowl
Leveling bubble	No
Locking type	Lever locks
Leg angle setting	By mid spreader
Leg angle	From 30° to 66°
Included mid spreader	Yes
Included ground spreader	No
Included spike foot shoes	Yes



545GB PRO HEAVY-DUTY VIDEO TRIPOD

The 545GB is the same as the 545B, except that it has a telescopic ground-level spreader instead of a mid-level spreader.

25kg 55.1 lb	69cm 27.2in	32,5cm 12.8in	158,5cm 62.4in	3,5kg 7.7lb

TECHNICAL SPECIFICATIONS 545GB

Head attachment	100mm bowl
Leveling bubble	No
Locking type	Lever locks
Leg angle setting	By ground spreader
Leg angle	From 29° to 63°
Included mid spreader	No
Included ground spreader	Yes
Included spike foot shoes	No



546B PRO VIDEO TRIPOD

Two-stage, extremely rigid, professional video tripod, able to carry loads up to 20kg (44lb). The 546B has a die cast aluminum crown with a built-in 75mm bowl. Leg locks are secure and reliable, and spiked feet with rubber overshoes are provided for solid grounding on both uneven terrain and smooth floors. The tripod can be used with various dollies.

The 546B has a telescopic mid-level spreader to help set leg angles accurately.



20kg 69cm 30cm 154cm 3,5kg
44lb 27.2in 11.8in 60.3in 7.7lb

TECHNICAL SPECIFICATIONS 546B

Head attachment	75mm bowl
Leveling bubble	No
Locking type	Lever locks
Leg angle setting	By mid spreader
Leg angle	From 30° to 66°
Included mid spreader	Yes
Included ground spreader	No
Included spike foot shoes	Yes



546GB PRO VIDEO TRIPOD

The 546GB is the same as the 546B, except that it has a telescopic ground-level spreader instead of a mid-level spreader.



20kg 69cm 32,5cm 158,5cm 3,5kg
44.1lb 27.2in 12.8in 62.4in 7.7lb

TECHNICAL SPECIFICATIONS 546GB

Head attachment	75mm bowl
Leveling bubble	No
Locking type	Lever locks
Leg angle setting	By ground spreader
Leg angle	From 29° to 63°
Included mid spreader	No
Included ground spreader	Yes
Included spike foot shoes	No



528XB PRO HEAVY VIDEO TRIPOD

The 528XB is the ideal location tripod, with a massive 50kg (110.2lb) load capacity. Tubes are made of stainless steel for strength under heavy loads, and aluminum for reducing the weight. The leg spread is fully adjustable, but also incorporates a 30° locked position for faster set up and greater strength. The 528XB includes a versatile mid-level spreader, which has telescopic “ratchet” braces that click into place in each of the preset positions for faster deployment. Each brace can be individually set, allowing each tripod leg to be separately positioned.

50kg 110.2lb	99cm 39in	73cm 28.7in	148cm 58.3in	7.4kg 16.3lb

TECHNICAL SPECIFICATIONS 528XB

Head attachment	100mm bowl + half ball included
Leveling bubble	No
Locking type	Knob locks
Leg angle setting	By mid spreader
Leg angle	From 25° to 41°
Included mid spreader	Yes
Included ground spreader	No
Included spike foot shoes	No

117B PRO VIDEO TRIPOD

The 117B features a geared central column that permits a fine adjustment of the camera height. The base is assembled using stainless steel extension legs for extreme corrosion resistance and extra long working life. The middle spreader is assembled with aluminum telescopic tubes that make the tripod flexible and rigid. Rubber feet and retractable metal spikes are included.

18kg 39.7lb	94cm 37in	46cm 18.1in	147cm 57.9in	173cm 68.1in	5.7kg 12.6lb

TECHNICAL SPECIFICATIONS 117B

Head attachment	Flat base with 3/8" screw + extendible center column
Leveling bubble	No
Locking type	Knob locks
Leg angle setting	By mid spreader
Leg angle	From 10° to 60°
Included mid spreader	Yes
Included ground spreader	No
Included spike foot shoes	No

MONOPODS

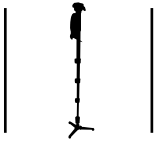

When shooting space is limited, when the amount and weight of equipment has to be kept to a minimum, or when set-up speed is of primary importance, a monopod is often the best solution to helping support a video camera and reduce camera shake. Monopods combine flexibility with high performance and fluidity, and can be useful in a vast range of situations and locations, many of which would be unsuitable for a tripod.

FLUID MONOPODS are a Manfrotto world-first: a patented system designed to help videographers obtain superior image quality from the kind of fluid camera movements unachievable with a standard monopod. An innovative fluid cartridge is incorporated in the base of the monopod to make panoramic rotations of the camera as smooth and judder-free as possible. The monopod base also has three retractable feet, which give it firmer footing and help keep the camera stable and reduce unwanted tilt.



The key feature of this monopods family is the fluid cartridge incorporated into the base that gives you an incredibly smooth panning action.



The three retractable feet ensure a firm footing and a great compactness while folded.



MVM500A FLUID VIDEO MONOPOD WITH SLIDING PLATE HEAD

The MVM500A is a fluid monopod with a specially adapted 500 video head attached. Combining the flexibility, reduced weight and innovative fluid pan cartridge of the monopod with the features of the head – its counterbalance system, tilt fluidity and locking, fast and secure side lock plate system, accessory Easy Link and pan bar – helps you get better footage from your camera than you would have thought possible with a monopod. Supplied with retractable feet.



2,4kg
5.3lb



5kg
11lb



77cm
30.3in



200cm
78.9in



2,8kg
6.2lb



500PLONG



562B-1 FLUID VIDEO MONOPOD

The 562B is a compact and high 4-section aluminum fluid monopod equipped with a 357PLV sliding camera plate adapter to adjust the camera's center of balance. This fluid monopod is ideal for camcorders up to 8kg (17.6lb). Supplied with retractable feet.

 max				
8kg 17.6lb	69cm 27.2in	193cm 76in	1,4kg 3.1lb	357PLV



560B-1 FLUID VIDEO MONOPOD





Compact and lightweight 4-section aluminum monopod with a fluid pan cartridge and a quick release tilt top with lock knob at the top gives you more flexible shooting angles and faster camera attachment without sacrificing the compactness of the monopod. Supplied with retractable feet.

 max				
2kg 4.4lb	65,5cm 25.8in	166cm 65.4in	1,2kg 2.6lb	200PL



MVM250A FLUID VIDEO MONOPOD

The MVM250A is a fluid video monopod that features a patented system using a fluid cartridge incorporated into its base for an incredibly smooth and judder-free panning action when shooting video. It is highly compact when folded thanks to its three retractable feet.

 max			
8kg 17.6lb	67cm 26.4in	191cm 75.2in	1,2kg 2.6lb



MVM50A FLUID BASE FOR MONOPOD

A fluid base that quickly transforms a photo monopod into a video monopod, adding the fluidity feature onto the PAN movement. MVA50A easily attaches onto the last section of a photo monopod and is suitable for:

- Manfrotto 679B, 680B and 558B
- All monopods featuring a ø20mm tube on the last section

0,4kg 0,8lb



SYMPLA FIG RIG SYSTEM

Hybrid DSLR cameras and ever-smaller, lighter camcorders with interchangeable lenses offer many advantages and opportunities, but have also introduced new problems to solve: much of the latest camera equipment doesn't have the ergonomic shape needed for steady, shoulder-mounted or hand-held footage. Sympla is Manfrotto's solution to these problems: a modular "ready to go" video rig system that extends and complements new cameras, enables stable support and framing and supports essential accessories.



MVA511WK-1 SHOULDER MOUNTED RIG

This rig allows support of camera equipment on your shoulder, with swivel-joint handles for perfect control and flexibility. The Shoulder Mounted Rig is ideal for use with HDSLRs and interchangeable lens camcorders, featuring fast camera connection thanks to the sliding plate with quick release. The Variable Plate is one of the most important components of the rig. This element permits to quickly adjust the position of the camera in combination with all the other accessories used, as the mattebox. The video equipment, such as HDSLR or Camcorder, can be easily controlled accessorizing this rig with the new HDSLR Remote Controls (ref. MVR911ECCN pag. 38 and MVR911EJCN pag.40). They put camera functions at your fingertips while letting you keep a firm grip on both handles.

Kit comprises: Shoulder Mount, Shoulder Pad, 300mm Rods (4), Variable Plate, 160mm H-Offset, Adjustable Handles, Spacers for handles (2), Clips (2), Rod Connectors (2), Light Counterweight, Spacer for Counterweight with adaptor

We recommend: Mattebox MVA512W, Clamp On HDSLR Remote Control MVR911ECCN Joystick HDSLR Remote Control MVR911EJCN.

- Weight: 4kg (8.8lb)



MVA525WK LIGHTWEIGHT SHOULDER MOUNTED RIG

The Lightweight Shoulder Mounted Rig is ideal for use with the latest HD SLRs, featuring fast camera connection thanks to RC2 quick release plate. The camera and its lens can be easily controlled by accessorizing this rig with the new HD SLR Remote Controls (ref. MVR911ECCN pag. 38 and MVR911EJCN pag.40). They put camera functions at your fingertips while letting you keep a firm grip on both handles.

Kit comprises: Shoulder Mount, Shoulder Pad, 300mm Rods (2), 150mm Rods (2), RC2 Mount, 80mm H-Offset, Adjustable Handles, Spacers for handles (2), Clips (2), Rod Connectors (2), Light Counterweight, Spacer for Counterweight with adaptor.

We recommend: Clamp On HD SLR Remote Control MVR911ECCN Joystick HD SLR Remote Control MVR911EJCN.

- Weight: 3,2kg (7.05lb)



MVA525W RC2 MOUNT

The RC2 mount is a lightweight solution in order to combine video equipment such as HD SLRs or light camcorders, with rail system. Thanks to its design, it is possible to adjust the operating height of the camera in two different positions, depending on the size of the body and the dimension of the lens. The RC2 quick release plate allows fast and secure connection between the camera and the rig.

- Camera attachment: Manfrotto RC2 quick release plate
- Material: Aluminum
- Load Capacity: 5kg (11lb)
- Weight: 0,29kg (0.64lb)

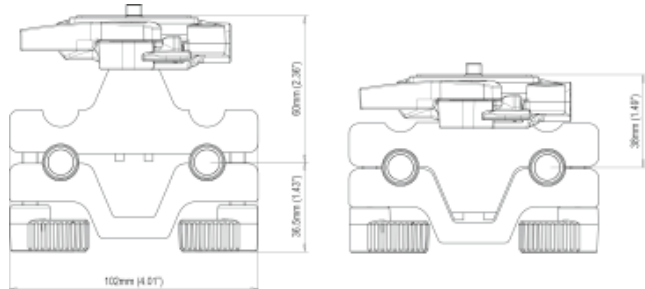

MVA518EXT EXTENSIONS FOR HANDLES

These machined aluminum spacers can be easily fitted on the adjustable handles to lengthen the arms. The same spacers also adapt the handles for use with Manfrotto clamp and joystick remote control units (ref. MVR911ECCN pag. 46 and MVR911EJCN pag.48).

- Weight: 0,09kg (0.2lb)



MVA518W ADJUSTABLE HANDLES

Sympla Adjustable Handles are fitted on a Universal Mount by two arms that can be angled independently. The handles are mounted on pivoting ball joints for easier adjustment: a twist of the single locking dial on each handle loosens or blocks all movement, allowing them to be rotated freely and quickly set at the exact position and angle required. The handles can be set in customary vertical or near-vertical positions, but also horizontally like motorbike handlebars. When a Sympla rig is mounted on a video head, the handles can be used as double pan bars.

Thanks to the Universal Mount, the Adjustable Handles can be easily removed and inverted to the upside down configuration.

The PVC-free Adjustable Handles are supplied with two metal spacers that can be fitted to lengthen the arms. The same spacers also adapt the handles for use with Manfrotto's clamp and joystick remote control units.

- Weight: 0,9kg (1.98lb)

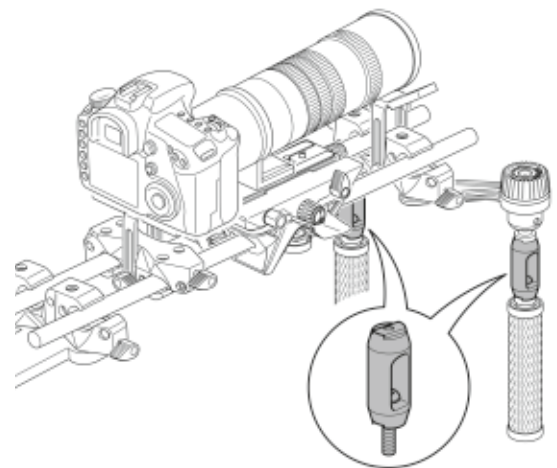



MVA514W LENS SUPPORT

The Sympla Lens Support has a rubber-coated V-profile element that can be raised until it rests solidly against the lens in order to stop it from vibrating when the lens L-bracket is being used to connect the camera to Sympla. A repositionable ratchet locking lever blocks height adjustment.

- Height range: 0 to 30mm (1.18"). For a greater height range, an additional Sympla V-Offset can be used.
- Weight: 0,33kg (0.73lb)



MVA517W UNIVERSAL MOUNT

The Universal Mount has an "open hook" design, which allows it to be inserted and hung on the Sympla rails from below, even between other elements that have already been positioned. Because it's self-supporting even when unlocked, it stays safely attached to the rails at all times. A single, repositionable locking lever conveniently blocks the Universal Mount solidly against both rails with one movement. The Universal Mount is extremely versatile, thanks to its 4 x 3/8" female threads and 2 x 1/4" female threads, which can be used to attach arms, adaptors and other components and accessories.

- Construction: aluminum fusion for reliability and robustness.
- Weight: 0,29 kg (0.64lbs)



MVA519S 80MM H-OFFSET

The H-Offset is normally used to join an off-center Shoulder Mount to a set of rails directly in front of the camera operator, so that the camera viewfinder or LCD screen can be more comfortably positioned and the weight of the camera and rig more ergonomically distributed.

- Weight: 0,2kg (0.44lb)



MVA523W-1 RODS - 150MM

A pair of 150mm (5.9") short Sympla rails, including 1/2"-13UNC screw junctions, with standard 15mm (0.59") diameter.

- Weight: 0,1kg (0.22lb)



MVA520W-1 RODS - 300MM

A pair of 300mm (11.8") long Sympla rails, including 1/2"-13UNC screw junctions, with standard 15mm (0.59") diameter.

- Weight: 0,18kg (0.4lb)



MVA500 EASY LINK CONNECTORS

Easy Link 3/8" connector to allow an external monitor or other accessory equipment to be fitted. It allows to support an external monitor or other accessories. Suitable for bridging heads and Sympla plates.

- Weight: 0,01kg (0.02lb)



MVA520 CONNECTORS FOR RODS

Aluminum red anodized connectors for rods. They feature a 1/2" - 13UNC screws in order to precisely connect two different rods.

- Weight: 0,04kg (0.09lb)

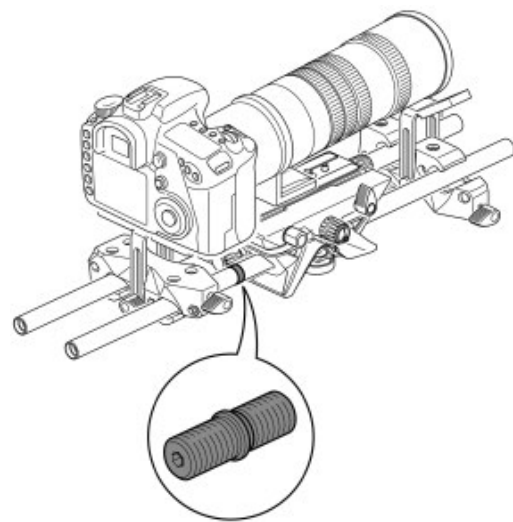
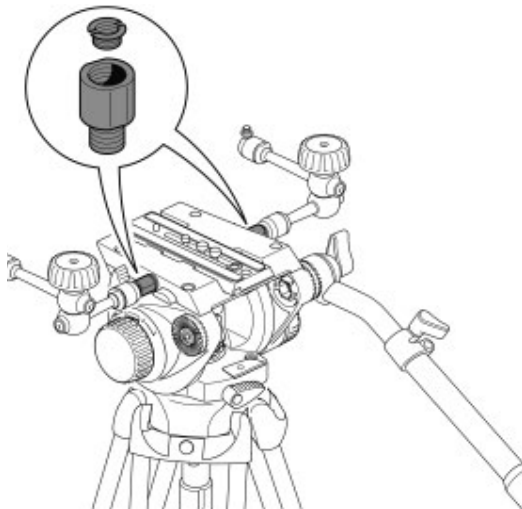



MVA521W COUNTERWEIGHT

Each counterweight weighs 1,6kg (3.5 lbs), and screws securely on to the SYMPLA Shoulder Pad via 3/8" thread. Counterweights can also be stacked to offset very unbalanced loads.
We recommend: Spacer for Counterweight MVA521.

- Weight: 1,6kg (3.5lb)



MVA521L LIGHT COUNTERWEIGHT

Each counterweight weighs 0.8kg (1.8lbs), and screws securely on to the Sympla Shoulder Pad via 3/8" thread. Counterweights can also be stacked to offset very unbalanced loads.
We recommend: Spacer for Counterweight MVA521.

- Weight: 0,8kg (1.8lb)



MVA521 EXTENSION TUBES FOR COUNTERWEIGHT

Aluminum spacer that moves the counterweight further back which effectively decreases the weight in front of the shoulder. It provides more balanced to the rig making shooting easier and more stable.

- Weight: 0,06kg (0.13lb)

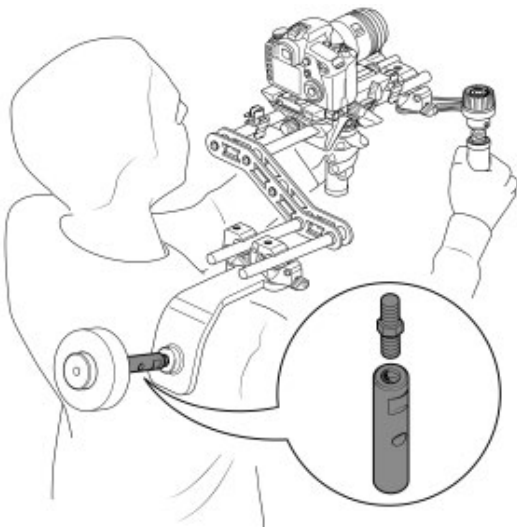



DIGITAL DIRECTOR

DIGITAL DIRECTOR is the only Apple certified (MFi - Made for iPad Certification) electronic device that connects your camera and iPad to help manage the photo and video workflow, from setting your camera to sharing your pictures. It works with Canon and Nikon DSLRs and iPad Air and Air 2.

KEY BENEFITS

- Dedicated CPU (micro-processor ARM® Cortex®-A8) that together with dedicated App, provides an interface between the two devices, which enables the camera protocols to be fully understood and controlled by the iPad via a cable, smooth video streaming and fast downloading of images.
- Great performance and reliability up to 10 mt (33ft) thanks to the USB cable connection. Digital Director also enables you to place the camera even in the most awkward or difficult to reach positions and conveniently control it remotely.
- Intuitive dedicated App that allows:
 - Live view monitoring and remote control of the key camera parameters.
 - Crisp and accurate focus thanks to the interactive focus and focus peaking.
 - Simple shot management: from image ratings to "Job" management.
 - Intuitive, immediate image and post production management of images.
 - Sharing of images via FTP, e-mail or social networks by simply moving the selected images in the iPad camera roll.





MVDDA13 DIGITAL DIRECTOR FOR iPad Air

Digital Director enables cabled remote control and live monitoring of Canon and Nikon DSLRs via an iPad application.

MVDDA14 DIGITAL DIRECTOR FOR iPad Air 2 (not illustrated)

Same as MVDDA13 but for iPad Air 2.



Micro-processor ARM® Cortex® A8 600Mhz 256MBDRAM.



Lightning connector.



USB connection (1m cable included).



Dedicated App.



Real time remote control of camera parameters.

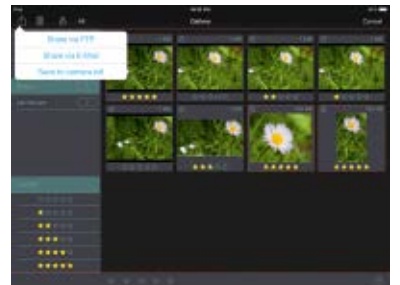

Simple management of the shoot.



REMOTE CONTROLS

Manfrotto remote control units put the most important commands of market leading video cameras, HD SLRs and lenses at your finger-tips. The range includes the world's first true electronic HD SLR remote controls - connected to the camera body via USB cable. They directly interface with camera and lens firmware protocols for optimum control over functions including focus, record start & stop, photo/video switching and shutter release, live view, digital zoom, aperture and exposure, ISO and more besides. Remote control unit firmware can be updated via USB.

Our remote control range includes both pan-bar and clamp-on models:

- pan-bar versions fit directly on Manfrotto fluid video heads and allow the cameraman to operate both head movement and camera features. He commands with one hand without having to touch the camera itself, which helps eliminate camera shake.
- Clamp-on versions are incredibly compact and can be attached to tubes, pipes, tabletops, Fig Rigs, handlebars and more. By extending the USB cable between the camera and the remote, clamp-on versions can be ideally suited for longer distance control, as slider or crane applications.

Both types of remote control are compatible with SYMPLA rigs and our Bridging Technology™ head range.

REMOTE CONTROLS FOR HD SLR A brand new range of Manfrotto remote controls for Canon HD SLRs promises a real innovation in the field of HD SLR filming – electronic remote control that works by interfacing with camera and lens firmware.

MVR911ECCN CLAMP-ON HD SLR REMOTE CONTROL for Canon

By interfacing directly with camera protocol via USB, the clamp-on electronic remote allows focus operations and main camera functions to be controlled from an extremely compact unit that attaches to a Sympla grip or other bar/pipe, remotely and without direct contact with the camera lens. This means lenses can be swapped easily without adjustment, camera movement is reduced to a minimum, and one-man camera operation is easier. In- and out- focus points and focusing speed can be set, auto-focus used, recording started & stopped, still images taken, and more besides. Fingertip control of key camera functions without moving the hand from the Sympla handles makes support more stable and secure.

- 3-step, ultra-precise focus speed
- Fixed or variable focus control modes
- Customizable focus speed limit
- Focus Memory settings
- Live View control
- Auto Focus control
- Live View Digital Zoom control
- Video recording start/stop
- Photo shutter release
- Remote control battery status
- Customizable focus direction
- Recording LED
- Video and Photo LED
- Clamp fits the spacer supplied with Sympla Adjustable Handles, or round tubes/pipes/bars/pan bars between 12mm (0.47") and 23mm (0.90") in diameter

Check the chart on the Manfrotto Web site for updates and new compatible cameras.





FRONT

- Autofocus
- Live View and Focus Memory 1
- Digital Zoom and Focus Memory 2
- Rec/Stop (video) and Shutter release (photo)
- Focus knob



LEFT SIDE

- Focus speed limit dial
- Focus mode switch – variable or fixed



RIGHT SIDE

- On / Off switch



TOP SIDE

- USB connection - to camera USB port.
- Extended length of supplied cable: 50cm
- Power connection to battery housed in lower shell of the clamp



BACK

- Battery housing (2 x AAA)

MVR911EJCN JOYSTICK HDSLR DELUXE REMOTE CONTROL for Canon

The Deluxe Remote Control is designed to be used as one of the hand grips of a Sympla shoulder support, where it means that a single camera operator can properly support the weight of the camera and rig to ensure smooth, accurate framing and movement, while also controlling all camera functions, without removing either hand from the rig. The Deluxe version can also be used hand-held and away from the camera and its support, it can be attached to video head pan bars or set up in any number of alternative configurations.

It electronically controls focus and both main and advanced camera operations and settings. The LCD screen on Manfrotto's Deluxe version remote relays general information from the camera, such as battery charge level, white balance temperature and memory card status – especially useful if the camera's on-body screen is inaccessible.

- 3-step, ultra-precise focus speed
- Fixed or variable focus control modes
- Customizable focus speed limit
- Focus Memory settings
- Live View control
- Auto Focus control and Auto Focus point selection
- Live View Digital Zoom control
- Video recording start/stop
- Photo shutter release
- Remote control and camera battery status
- Customizable focus direction
- ISO
- Shutter speed
- Aperture
- Colour temperature
- Exposure level

Check the chart on the Manfrotto Web site for updates and new compatible cameras.

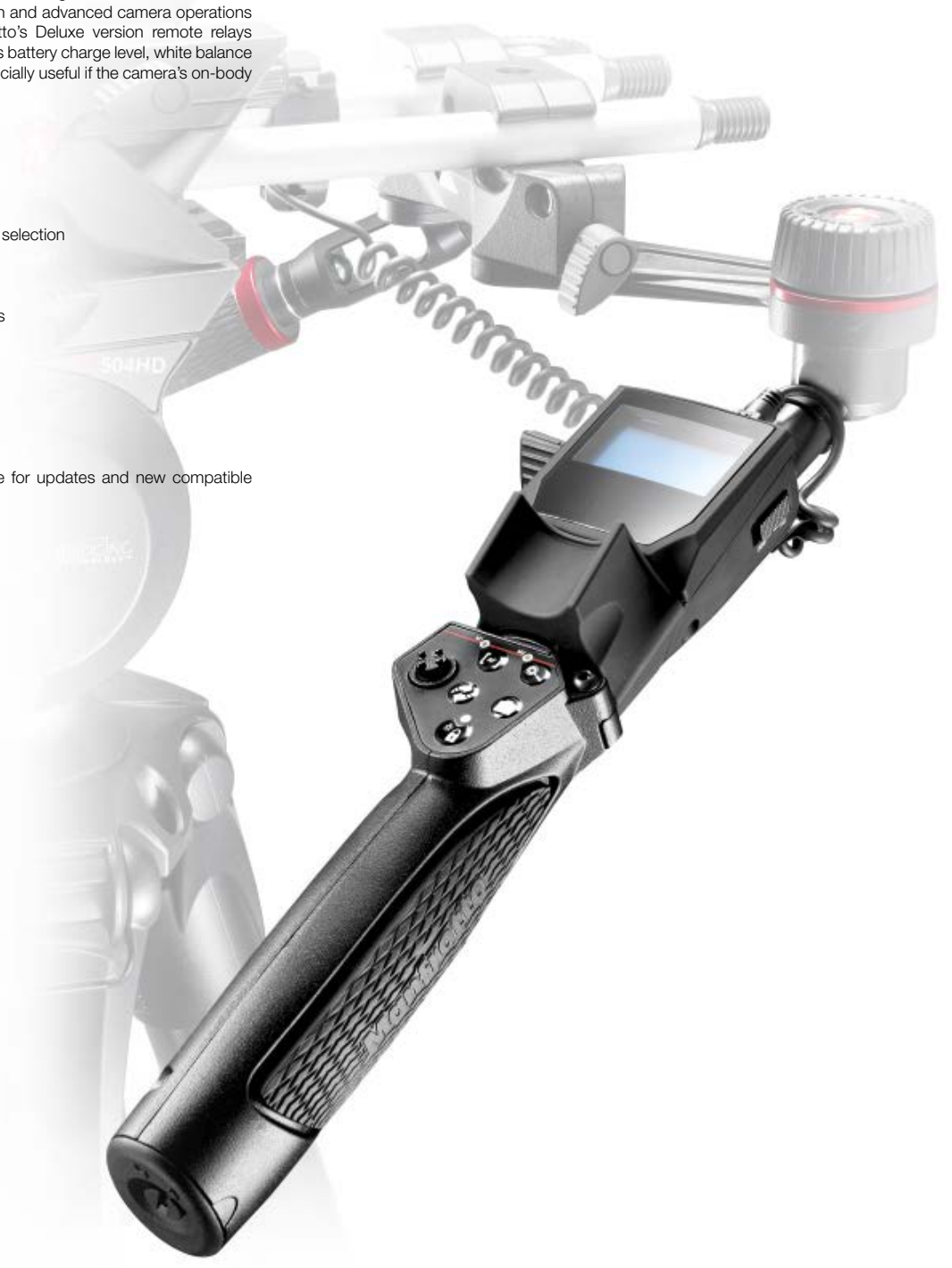



FRONT

- Display screen (see schematic diagram)
- Focus knob
- Autofocus and Focus Memory 1
- Digital Zoom and Focus Memory 2
- Autofocus joystick
- Photo / Video mode switch
- Live view
- Function lock and backlight



BACK

- Focus speed limit and Menu set-up dial



LEFT SIDE

- Rec/Stop (video) and Shutter release (photo) button



RIGHT SIDE

- USB connection - to camera USB port. Extended length of supplied cable: 50cm
- On/Off switch
- Batteries (4 x AA) housed in handgrip

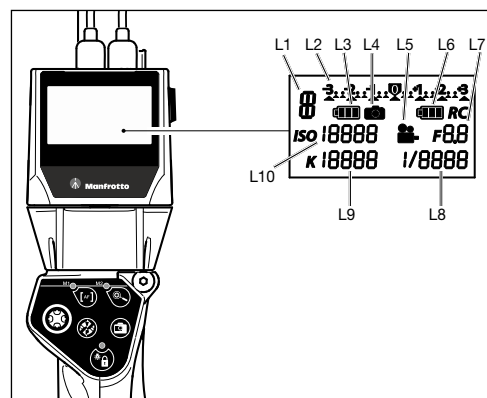

LCD SCREEN

- L1. CAMERA MODE DIAL
- L2. EXPOSURE LEVEL INDICATOR
- L3. CAMERA BATTERY CHECK
- L4. CAMERA MODE
- L5. VIDEO MODE
- L6. REMOTE CONTROL BATTERY CHECK
- L7. APERTURE INDICATOR
- L8. SHUTTER SPEED
- L9. COLOR TEMPERATURE INDICATOR
- L10. ISO INDICATOR

REMOTE CONTROLS FOR CAMCORDERS Manfrotto renews and extends the family of accessories built for the latest cameras (JVC's GY-HM600 and GY-HM650 series, and the eagerly anticipated Blackmagic Cinema Camera) through new restyled remote controls. A new family of renovated products in terms of ergonomics and design, compatible with all protocols and applications. Manfrotto Remote Control units put the most important commands of market-leading video cameras and lenses at your finger-tips.



KEY FEATURES

- Quick-lock fastening clamp with steel core
- Anti-slip soft touch finishing
- Heavy-duty, anti-scratch, dirt-repellent polycarbonate film keyboard
- Wide-rotation (+-50°) Multispeed Zoom/Focus knob
- Direct adjusting of maximum zoom speed
- Functional LEDs

KEY BENEFITS

- Quick fastening on the pan bar
- "Fast zoom" and "Max speed" controls allow for quick camerasetup
- Wide and smooth zoom control



12 to 23mm / 0,47" to 0,90" round tube/pipe/bar grippable diameter.



Anti-scratch. Dirt-repellent keyboard.



Zoom / Focus knob.



Quick lock



Zoom Speed limit.



Remote Control can be set-up for LANC (Canon/Sony) and Panasonic cameras.

MVR901ECPL CLAMP-ON REMOTE CONTROL **SC** **P**

Remote control can be set-up for LANC (Canon/Sony) and Panasonic cameras.

- LANC/Panasonic switch
- Stand-by push button (for LANC only)
- REC/STOP push button
- Multi-speed Zoom knob
- REC/STOP LED (for LANC only)
- Zoom direction knob (by software)



MVR901ECLA LANC REMOTE CONTROL **SC**

Advanced remote control for LANC (Canon/Sony) cameras.

- Stand-by push button
- REC/STOP push button
- Zoom and focus direction knob (by software)
- Multi-speed Zoom and Focus knob
- Max-speed zoom potentiometer
- Rec, Zoom and Focus indicator LED's



MVR901ECEX CLAMP-ON REMOTE CONTROL **EX**

Remote control compatible with Sony PMW EX-family cameras.

- REC/STOP push button
- Zoom direction switch
- Multi-speed Zoom knob
- Max-speed Zoom potentiometer
- RET push button (plays back latest 5s)
- Power indicator LED
- Fast zoom push buttons



Key to symbols

SC SONY - CANON

EX SONY EX

P PANASONIC

REMOTE CONTROLS FOR PAN BARS The Pan Bar version of the RC family has been totally restyled by focusing on their ergonomics, setup and new functionalities of the cameras. Thanks to innovative solutions, refined layouts and a thorough study of materials, all new RC models perfectly balance lightness, sturdiness and fluidity as required by professionals. In order to pursue innovative and eco-friendly solutions, PVC-free handle have been introduced for the first time.

KEY FEATURES

- Aluminum fixing rosette, compatible with Manfrotto video heads
- Accessory clamp for attaching to any pan bar
- Anti-slip softouch finishing
- PVC-free grip
- Heavy-duty, anti-scratch, dirt-repellent polycarbonate film keyboard
- Wide-rotation (+-40°) multi-speed Zoom/Focus knob
- Direct adjusting of maximum zoom speed

KEY BENEFITS

- Wide range of fastening solutions
- Wider Zoom/Focus knob, for better control
- A thorough set of controls and precision mechanics for a smooth and customizable zooming and focusing
- IRIS remote control for enabled cameras



Direct coupling with Manfrotto heads for maximum rotation control.



Direct adjusting of maximum zoom speed.



Rotatable pan bar.



PVC-free "high-textured" handle.



Wide and ergonomic Zoom/Focus knob.

MVR901EPLA PAN BAR REMOTE CONTROL

SC

Pan-bar remote control for cameras with LANC (Sony and Canon).

- REC/STOP
- Push Button
- Max-speed Zoom potentiometer
- Stand-by push button
- RET push buttons (play back latest 5s)
- IRIS Push Button
- REC, Zoom and Focus indicator LED's
- Zoom and focus direction knob (by software)
- Multi-speed Zoom and Focus knob
- Focus/Zoom switch
- Auto/Man Focus switch



MVR901EPEX PAN BAR REMOTE CONTROL

EX

Remote control with standard pan bar for Sony PMW EX-family cameras

- REC/STOP push button
- Zoom direction switch
- Multi-speed Zoom knob
- Max-speed Zoom potentiometer
- RET push button (plays back latest 5s)
- Power indicator LED
- Fast zoom push buttons



522AV ADAPTOR CABLE FOR AV-R SONY CONNECTOR

Made for video cameras with the AV-R plug, the 522AV converts the possibility to connect to these type of cameras all the Manfrotto remote controls.



522SCA REMOTE CONTROL CABLE STANDARD

2.5mm male/male jack coiled cord cable measuring 140cm (55in) when extended, supplied as standard with all the units.



523RC RAIN COVER FOR REMOTE CONTROL

Waterproof cover for Manfrotto remote control supplied with a crystal clear vinyl panel allows the viewing of the remote control button during the shooting session. The cover slips quickly over the remote pan bar to protect it from rain or sudden showers.



MVR901APCL PAN BAR CLAMP ADAPTOR

Manfrotto attachment, casting teeth.
Clamp Range: round tube 19 to 25mm.
Quick-fastening system.





ALTERNATIVE SUPPORTS

Manfrotto arms, clamps and other alternative supports and accessories are fundamental video support “tools” needed to create the perfect supporting solution in every situation.



244MINI MINI FRICTON ARM

24cm (9.4in) friction arm with interchangeable 1/4" attachments and additional 3/8" adapter included.



3kg
6.6lb



0,44kg
0.97lb



244MICRO MICRO FRICTON ARM

15cm (5.9in) friction arm with interchangeable 1/4" attachments and additional 3/8" adapter included.



3kg
6.6lb



0,22kg
0.49lb



244MICRO-AR MICRO FRICTON ARM WITH ANTI ROTATION

15cm (5.9in) friction arm with interchangeable 3/8" Anti-rotation attachments and additional 3/8" adapter included. The Anti-rotation system is compatible with Manfrotto products: Digital Director and 386B-1 Nano Clamp.



3kg
6.6lb



0,24kg
0.53lb



244MICROKIT MICRO FRICTON ARM WITH NANO CLAMP

15cm (5.9in) friction arm with interchangeable 3/8" Anti-rotation attachment and 1/4" attachment and Nano Clamp included. The Anti-rotation system is compatible with Manfrotto products: Digital Director and 386B-1 Nano Clamp.



3kg
6.6lb



0,31kg
0.69lb



244ADPT58 5/8" ADAPTERS

Two 5/8" adapters accessories compatible with the following friction arms: 244Mini, 244Micro, 244Micro-AR, 244MicroKit.



244ADPT3814 3/8" AND 1/4" ADAPTERS

3/8" and 1/4" adapters accessories compatible with the following friction arms: 244Mini, 244Micro, 244Micro-AR, 244MicroKit.



244ADPT38AR 3/8" ANTI-ROTATION ADAPTER

Anti-rotation adapter accessory compatible with the following friction arms: 244Mini, 244Micro, 244Micro-AR, 244MicroKit. The Anti-rotation system is compatible with Manfrotto products: Digital Director and 386B-1 Nano Clamp.



244ADPT-HS HOT-SHOE ADAPTER

Hot-shoe adapter accessory compatible with the following friction arms: 244Mini, 244Micro, 244Micro-AR, 244MicroKit.



244RC VARIABLE FRICTION ARM WITH QUICK RELEASE PLATE

Articulated arm with large locking knob. Variable friction and locking of arm obtained by adjusting the knob. Supplied with quick release camera plate with secondary safety lock based on the 200PL-14 camera plate mechanism. Ideal for mounting a video camera exactly at the angle you need it. Fits any 5/8" female socket, works especially well with Super Clamp 035C.



3kg
6.6lb



1,1kg
2.4lb



200PL-14



143RC MAGIC ARM WITH QUICK RELEASE PLATE

Your extra arm in the studio. One lever locks three pivot points. Supplied with a quick release camera plate with secondary safety lock based on the 200PL-14 system. Ideal for mounting a camcorder exactly at the angle you need it. Fits any 5/8" female sockets, works especially well with Super Clamp 035C.



4kg
8.8lb



1,1kg
2.4lb



200PL-14

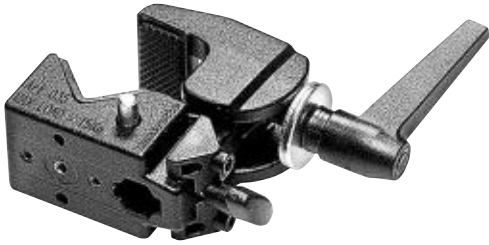

035C SUPER CLAMP

This universal clamp can be securely mounted on any tube from 13 to 45mm (0.5 to 1.8in). Attachment is 5/8" hexagonal socket, plus 1/4" female thread.



15kg
33.1lb



0,5kg
1.1lb

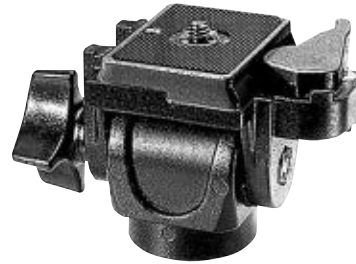

234RC MONOPOD QUICK RELEASE TILT TOP

Tilt head with quick release camera plate system and secondary safety lock.



2,5kg
5.5lb



6cm
2.4in



0,3kg
0.6lb



200PL-14



386BC-1 NANO CLAMP

The new Manfrotto small size clamp. Its reduced size is the most important plus: the Nano Clamp is 4kg (8.8lb) of payload in 110g (2.4lb) of weight and the right size for any pocket.

The Nano Clamp is also a full pack of new technological advances:

- a new patented unexposed thread system
- a new high friction tape which improves the grip
- high performance aluminum
- pull and lock aluminum handle
- unique surface design that was studied on the smallest surface to be able to grip round or flat tube/pole surface.

The clamp comes with a 1/4"-3/8" female thread and 1/4"-3/8" adapter.



4kg
8.8lb



0,1kg
0.2lb



241FB PUMP CUP WITH FLAT BASE

Suction cup for lightweight video cameras. The 60mm (2.4in) diameter disc with a 3/8" W male thread is built in the pump cup and enables you to mount most of Manfrotto's heads.



0.6kg
1.4lb



241 PUMP CUP

Suction cup for small equipment.
Diameter: 150mm (5.9in).



1.2kg
2.6lb



037 CAMCORDER MOUNTING STUD

Reversible stud with 3/8" and 1/4" designed for mounting camcorders on Super Clamp 035C.



0.04kg
0.09lb



MVA500 EASY LINK CONNECTORS

Easy Link 3/8" connector to allow an external monitor or other accessory equipment to be fitted. It allows to support an external monitor or other accessories. Suitable for bridging heads and Sympla plates.



0.02kg
0.04lb



ACCESSORIES

HEAD ACCESSORIES: the Manfrotto head accessory system includes a wide range of products that satisfy all the customer needs in terms of camera attachment and customized pan bar. All the Manfrotto plates are made of aluminum with a travelling distance up to 140mm (5.5in). Also the Manfrotto pan bars are assembled with aluminum tubes with a maximum extension of 58cm (22.8in).



323 RECTANGULAR VIDEO QUICK RELEASE ADAPTER

This quick release adapter gives you the freedom to remove the camera from the head without detaching it from the plate and put it on any other support. Supplied with 1/4" camera screw. Dimensions: 74x26x65,5mm (2.9x1x2.6in).



577 VIDEO QUICK RELEASE ADAPTER

This quick release adapter gives you the freedom to remove the camera from the head without detaching it from the plate and put it on any other support. Supplied with 1/4" and 3/8" camera screws. Dimensions: 90x23x100mm (3.5x0.9x3.9in) - 20mm (0.8in) travel.



357 ADAPTER

This quick release adapter gives you the freedom to remove the camera from the head and put it on any other support. Supplied with 2x1/4" and 2x3/8" camera screw. Dimensions: 140x22x101mm (5.5x0.9x4in) - 80mm (3.1in) travel .



200PL-14 VIDEO CAMERA PLATE

This standard plate is supplied with 1/4" camera fixing screw. Dimensions: 53x10x42,3mm (2.1x0.4x1.7in).



501PL VIDEO CAMERA PLATE

This standard sliding plate is supplied with 1/4" and 3/8" camera fixing screws. Dimensions: 90x11x50,5mm (3.5x0.4x2in).



500PLONG VIDEO CAMERA PLATE

Sliding camera plate, suitable for all Bridging Technology™ Manfrotto Video Heads. Originally supplied with the Manfrotto Video Heads MVH500A and MVH500AH. Supplied with 1x1/4", 1x3/8" camera screws and anti-rotation pin. Dimensions: 120x10x50mm (4.7x0.4x2in).



501PLONG VIDEO CAMERA PLATE

The long version of the standard plate, that has a laser engraved scale (110mm), features a variable VHS pin position. This can be moved along the length of the plate. Supplied with 2 x 1/4" and 2 x 3/8" camera fixing screws. Dimensions: 140x10x50 mm (5.5x0.4x2in).



504PLONG VIDEO CAMERA PLATE

Sliding camera plate, suitable for all Bridging Technology™ Manfrotto Video Heads. Originally supplied with the Manfrotto Video Heads MVH502A, MVH502AH and 504HD. Supplied with 2x1/4" and 2x3/8" camera screws and anti-rotation pin. Dimensions: 140x10x50 mm (5.5x0.4x2in).



509PLONG VIDEO CAMERA PLATE

Sliding camera plate, suitable for Manfrotto Video Heads. This plate works together with the new ABR (Advanced Balancing Recorder) system, thanks to a special built-in index. Originally supplied with the Manfrotto Video Head 509HD. Supplied with 2x1/4" and 2x3/8" camera screws and anti-rotation pin. Dimensions: 140x10x50 mm (5.5x0.4x2in).



357PLV VIDEO CAMERA PLATE

This standard sliding plate is supplied with 2x1/4" and 2x3/8" camera fixing screws. Dimensions: 140x10x44mm (5.5x0.4x1.7in).



357PLONG VIDEO CAMERA PLATE

This long version of the standard plate allows perfect balance for camcorders with unusual weight distribution caused by long telescopic lenses or heavy batteries. Supplied with 2x1/4" and 2x3/8" camera screws. Dimensions: 210x10,5x56mm (8.3x0.4x2.2in).



500BALLSH 100MM SHORT HALF BALL

The 500BALLSH comes complete with a short locking handle to mount all Manfrotto flat-base heads to the 529B Hi-Hat. Length 12,5cm (4.9in). Attachment: 3/8" male thread.



520BALLSH 75MM SHORT HALF BALL

The 520BALLSH comes complete with a short locking handle to mount all Manfrotto flat-base heads to any 75mm bowl tripod including the 529B Hi-Hat (with optional adapter 319). Length 11,5cm (4.5in). Attachment: 3/8" male thread.



560BALLSH 60MM HALF BALL

Half ball for leveling video heads on video tripods provided with a 60mm bowl. Length: 16cm (6.3in) Attachment: 3/8" male thread.

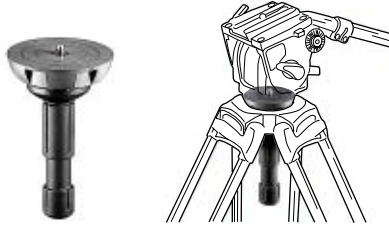

500BALL 100MM HALF BALL

Half ball for leveling video heads on video tripod. Length 17cm (6.7in). Attachment: 3/8" male thread.

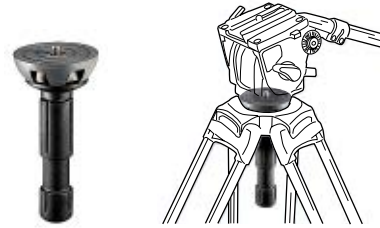

520BALL 75MM HALF BALL

Half ball for leveling video heads on video tripods provided with 75mm bowl. Length 16cm (6.3in). Attachment: 3/8" male thread.

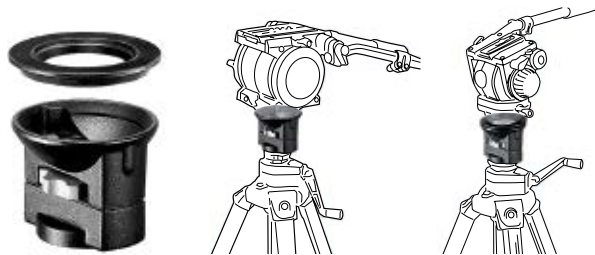

325N VIDEO HEAD BOWL ADAPTER

Adapter system to connect a 75 or 100mm half bowl video head to a flat base tripod.



500HLV PAN BAR

Pan bar for the MVH500A and MVH500AH fluid video heads. Length 34cm (13.4in).

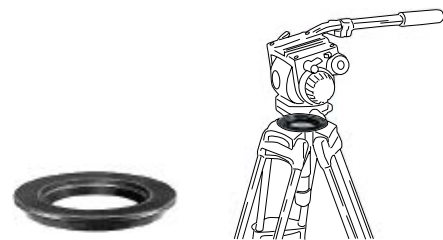

319 100MM TO 75MM ADAPTER

Converts all Manfrotto 100mm bowl tripods into a 75mm bowl.



502HLV PAN BAR

Pan bar for the MVH502A and MVH502AH fluid video heads. Length 35,5cm (14in).



MVA060T 75MM TO 60MM ADAPTER

Converts all Manfrotto 75mm bowl tripods into a 60mm bowl.



509HLV PAN BAR

Pan bar for the 504HD and 509HD fluid video heads. Max length 63cm (24.8in) - Min length 39cm (15.3in) - Extension 23cm (9in).

TRIPOD ACCESSORIES: in order to customize your tripod for every different environment, the Manfrotto tripod accessories range includes a complete set of different dollies, spreaders and reversible spiked feet.



114 VIDEO DOLLY

Heavy duty, super sturdy, designed for use with large video tripods; individually braked wheels with cable guards. Folds for transporting. Includes 3/8" attachment which allows you to attach a head for low angle shooting.



60kg
132.3lb



8kg
17.6lb



112cm
44.1in



114MV PORTABLE DOLLY

Same as 114 dolly with ability to accept spiked tip tripods. Includes 3/8" attachment which allows you to attach a head for low angle shooting.



60kg
132.3lb



6,2kg
13.7lb



112cm
44.1in



181B FOLDING AUTODOLLY

Single lever braking system controls all three 80mm wheels. It folds legs for transporting and storage. Includes 3/8" attachment which allows you to attach a head for low angle shooting.



25kg
55.1lb



4,5kg
9.9lb



127cm
50in



127 VIDEO DOLLY

Designed for light and medium weight tripods. The 76mm wheels have a sure-lock feature that raises the wheels free off the ground so that the dolly then rests on extended feet. Includes 3/8" attachment which allows you to attach a head for low angle shooting.



10kg
22lb



2,4kg
5.3lb



110cm
43.3in



127VS BASIC DOLLY

Everything that the 127 has with the ability for a variable spread for the legs. Suitable for standard and spiked feet. Includes 3/8" attachment which allows you to attach a head for low angle shooting.



10kg
22lb



3,4kg
7.5lb



78-114cm
30.7-44.9in

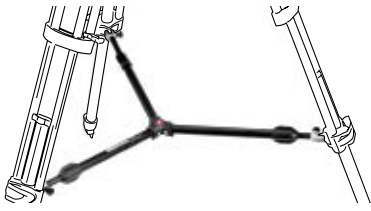

537SPRB MID LEVEL SPREADER

The new telescopic mid-level spreader allows you to set the proper leg angle and resulting tripod footprint.



165 TRIPOD SPREADER

Universal tripod spreader with variable diameter width controls from 80 to 130cm (31.5 to 51.2in).



0.65kg
1.43lb



80-130cm
31.5-51.2in



165MV TRIPOD SPREADER FOR SPIKED FEET

Universal tripod spreader with variable diameter width controls from 80mm to 130mm (31.5 to 51.2in). It accepts spiked tip tripod.



0.65kg
1.43lb



80-130cm
31.5-51.2in



204SPK3 REVERSIBLE SPIKED FEET

Reversible rubber/metal spiked feet (set of 3) supplied with a dedicated fixing tool. The spike is made of a special hard anodized aluminum alloy extremely resistant to corrosion. See chart below for tripod compatibility.



204SCK3 SUCTION CUP/RETRACTABLE SPIKED FEET

A rubber suction cup feet (set of 3) with retractable stainless steel spike. The suction cup increases the footprint of the foot by almost 20 times, giving much greater stability when needed. See chart below for tripod compatibility.



565 SPIKED FOOT SHOES

Set of 3. See chart below for tripod compatibility.

TRIPOD MODELS	DOLLY					MID SPREADER	SPREADER		REVERSIBLE FEET	SUCTION CUP FEET	
	114	114MV	181B	127V	127VS	537SPRB	165	165MV	204SPK3	204SCK3	565
545B		X	X					X			
545GB		X	X			X					X
546B		X	X					X			
546GB		X	X			X					X
MVT502AM											
MVT535AQ											
535	X			X	X						
536	X			X	X						
755CX3									X	X	
755XB									X	X	
528XB	X			X	X		X				
117B	X			X	X		X				

PLEASE NOTE: this chart only shows technical compatibility. When assembling the products always consider the maximum load of the component with the lowest loading capacity.



492LCD LCD MINI BALL HEAD

The 492LCD mini ball head is a swivel mounting accessory that can be attached to the bottom of LCD or TFT monitors so you can mount the monitor to the top of the camera by using the "hot shoe" located on the top of most camcorders.

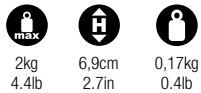

2kg
4.4lb

6,9cm
2.7in

0,17kg
0.4lb



529B HI-HAT

529B Hi-Hat enables you to get shots from the dog's perspective. The 529B has a 100mm half-bowl, adjustable leg angles to mount the camera in the tightest or lowest of locations and thanks to the built-in spreader you can simply use the 529B on any even surface. The feet are rubber-padded to protect delicate surfaces and have a hole so that the 529B can be screwed to a ladder, apple-box or a sheet of wood.

Recommended heads:

- 526
- 509HD
- 504HD (with 319 adapter)
- MVH502A (with 319 adapter), MVH502AH (with 500BALLSH half ball)



20kg
44.1lb

14,5cm
5.7in

19,5cm
7.7in

20,5cm
8.1in

2,7kg
6lb



MVT535HH HI HAT

Manfrotto MVT535HH is a single leg Hi-Hat that's lighter than the 529B (twin leg Hi-Hat). This is the perfect choice if you're looking for a simple yet sturdy solution for ground level shooting, slider support and table tripod application (heavy cameras). It features a Single Section for maximum compactness and Ø 75-60mm half bowl for quick leveling. The leg angle selector allows users to adjust operating height as needed. Its aluminum casting components make it a sturdy and reliable solution. It also includes the MVA060T adapter which converts the 75mm into a 60mm half bowl.

Recommended heads:

- MVH500A
- MVH500AH + 560BALLSH 60MM HALF BALL ADAPTOR
- MVH502A
- MVH502AH + 520BALLSH 75MM SHORT HALF BALL ADAPTOR
- 504HD

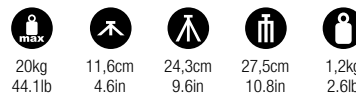

20kg
44.1lb

11,6cm
4.6in

24,3cm
9.6in

27,5cm
10.8in

1,2kg
2.6lb



BAGS AND STRAPS

Not only bags!! But I would leave it off and start with Manfrotto video product range is completed with a range of soft goods that allows an easy transportation and storage. A complete family of padded bags developed with multihandles and internal pockets, six different dimensions from the smallest MB MBAG70N up to the largest MB MBAG120PN. Different typologies of straps are available, presenting different design and materials for alternative carrying solutions.



Easy access even with the bigger video tripods.



Rebated zippers.



Thermoformed padding with the new Manfrotto logo.



Attention to details: small injected Manfrotto logo on the handles.



Comfortable carrying handle.



Rubberized Manfrotto loop, helps when using the zips. This feature is used on all the new Manfrotto bags, functional and iconic.



Inner pocket for tripod accessory storage.



MB MBAG120PN

MB MBAG100PN

MB MBAG90PN

MB MBAG80PN

MB MBAG80N

MB MBAG70N

MB MBAG120PN 120CM PADDED TRIPOD BAG

The largest bag in the range, the MB MBAG120PN is padded to protect your equipment and has the following features:

- Asymmetric tapered shape allows you to store the tripod with the head attached. Tripod legs fit comfortably in the narrower end and extra space is allowed for the larger volume of the head at the wider end. Diameter 23cm (9.1in).
- Zipper extends down the length of the bag, but also fully opens the top end of the bag.
- Thermoform padding holds the tripod in place in the bag and protects it, especially the head, during transport.
- Inner pocket holds accessories (such as video head pan bars).
- Innovative design and style; ballistic nylon, zips and other materials used are of top quality.
- Can be hand-carried horizontally by the side handle, vertically by the end handle (also useful for storage), or shoulder-carried using the included strap.

MB MBAG100PN 100CM PADDED TRIPOD BAG

Same design of MB MBAG120PN 20cm smaller and without the double positioning carrying handle. Diameter 23cm (9.1in).

MB MBAG90PN 90CM PADDED TRIPOD BAG

Same design of MB MBAG120PN 30cm smaller and without the double positioning carrying handle. Diameter 23cm (9.1in).

MB MBAG80PN 80CM PADDED TRIPOD BAG

Same design of MB MBAG120PN 40mm smaller and without the side handle or inner accessory pocket. The MB MBAG80PN is also narrower than the other padded bags. The narrow end measures 13cm (5.1in) diameter, the wide end measures 15cm (5.9in).

MB MBAG80N 80CM UNPADDED TRIPOD BAG

The MB MBAG80N is an unpadded tripod bag.

- Slightly tapered to provide a better fit for your tripod with attached head. The wider end of the bag accommodates the head without requiring all levers to be removed.
- Zipper extends down the length of the bag, but also fully opens the top end of the bag.
- Logo end cap is padded to offer protection to the tripod head, the rest of the bag is unpadded.
- Shoulder strap included (the MB MBAG80N doesn't have either end or side handle).
- Innovative design and style; ballistic nylon, zips and other materials used are of top quality. Diameter 13cm (5.1in).

MB MBAG70N 70CM UNPADDED TRIPOD BAG

Same design of MB MBAG80N 10cm smaller.



401N QUICK ACTION STRAP

A quick and easy accessory for carrying your tripod when walking, hiking, cycling or just getting from shoot to shoot. Use the shorter straps to fasten the padded 401N to one of the legs of your tripod, bind the remaining legs together using the longer adjustable quick release straps, sliding the tripod over your shoulder and you're ready to go, with your hands free to grab those vital last minute items. The padding helps hold the tripod in place and protects your back from bruises and chaffing. The 401N even stays attached to your tripod when shooting (all you need to do is release the longer quick release straps so you can maneuver and position all three legs), so you're always ready to capture the images you want, but also always ready to move off again to the next location.



Straps can be removed and custom-positioned to better match the size of your tripod.

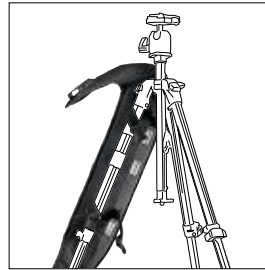

The strap stays attached to your tripod when shooting.

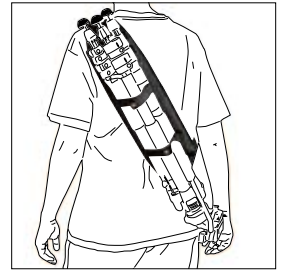

MSTRAP-1 TRIPOD SHOULDER STRAP

The MSTRAP-1 allows you to carry the tripod when attached to the ring positioned right under the tripod collar.



MSTRAP-2 TRIPOD HANDLE STRAP

The MSTRAP-2 is a convenient and smart way to carry a video tripod plus a head. The ergonomics of this strap allows to carry easily the products. Safe grip thanks to the rubber coated adjustable velcro. Easy to mount, safely hooked to the upper casting of the tripod. Well balanced, also with heavy duty video heads, thanks to the ergonomics of the handle.



102 LONG STRAP

The 102 strap is a basic but convenient way to carry your system. It has a spring clip that fastens quickly to the steel ring at the shoulder of the tripod, and a closed loop that goes around the feet of the tripod and tightens to grip them securely. Features an adapter for compatibility with all Manfrotto tripods and rubberized fabric for comfort and to avoid the tripod slipping on your shoulder.



















402 SHORT STRAP

The 402 is a simple loop strap, with a single spring clip that attaches quickly to the steel ring at the shoulder of your tripod. Features an adapter for compatibility with all Manfrotto tripods. Strap is in grey rubberized fabric for comfort and to avoid the tripod slipping on your shoulder.

Key to symbols

Tripod symbols

-  Twin leg
-  Single leg
-  Flat base
-  60mm + 75mm bowl
-  75mm + 100mm bowl
-  75mm bowl
-  100mm bowl
-  60mm bowl + half ball included
-  75mm bowl + half ball included
-  100mm bowl + half ball included
-  Flat base with 3/8" screw + extendible (geared) center column
-  Leveling flat base with 3/8" screw + extendible center column
-  Aluminum
-  Carbon Fiber
-  1 stage
-  2 stages
-  3 stages

Closed length 

Minimum height 

Maximum height 

Maximum height with extended center column 

Monopod minimum height 

Monopod maximum height 

Footprint diameter 

Counterbalanced weight
Suggested maximum weight that the product can properly balance. It indicates the working (dynamic) payload, without the help of tilt brake 

Safety payload
Maximum weight that the product can carry/support in static condition. Ability of the head to support, move and lock (with pan&tilt brakes) a certain weight 

Weight 

Head height 

Plate supplied with the head 

Head symbols

 C.O.G.

C.O.G.: Center Of Gravity is the weighted average location of all the mass in a body. Depending on the dimensions of the camera, the distance from the plate to the C.O.G. will be longer or shorter. Lightweight/compact cameras and DSLRs will have a shorter distance from the plate to the C.O.G. and bigger cameras will have a longer distance from plate to C.O.G. Video head performance is measured with different distances of COG according to the load capacity of the head.

We use two standard C.O.G. measurements:
 - @ 55mm for Ø60-75mm half bowl heads 701HDV, MVH500A(H), 501HDV, MVH502A(H), 504HD
 - @ 125mm for Ø100mm half bowl heads (509HD, 526)

 CBS

CBS is our Counterbalance System; a fundamental part of what makes our video heads such useful video tools. The principal function of CBS is to cancel out the slow falling effect seen in video footage when the videocamera's own weight causes it to tilt forward or backward on an unbalanced video head. CBS ensures that the cameraman need only apply minimal effort to the head's pan bar to move the camera precisely and smoothly.

 FDS

FDS is a friction system used across the Manfrotto video head and monopod ranges, based on specially developed cartridges that make movements fluid and help stop unwanted vibrations (such as those from the video operator's own hand) being transmitted. Our range uses two types of FDS: fixed and variable. Variable FDS allows you to regulate and control the level of friction applied based on the type and style of video you're shooting, on the weight of your camera equipment and on climatic conditions and temperature.

 ABR

Our patented electronic system allows you to record the position at which a particular equipment set-up is perfectly balanced, and then recall that position easily any time you need to use the same equipment again.



INDEX

Art. N°	Description	Page
035C	SUPER CLAMP	48
037	CAMCORDER MOUNTING STUD	49
102	LONG STRAP	58
114	VIDEO DOLLY	52
114MV	PORTABLE DOLLY	52
117B	PRO VIDEO TRIPOD	27
127	VIDEO DOLLY	53
127VS	BASIC DOLLY	53
143RC	MAGIC ARM WITH QUICK RELEASE PLATE	47
165	TRIPOD SPREADER	54
165MV	TRIPOD SPREADER FOR SPIKED FEET	54
181B	FOLDING AUTODOLLY	53
200PL-14	VIDEO CAMERA PLATE	50
204SCK3	SUCTION CUP/RETRACTABLE SPIKED FEET	54
204SPK3	REVERSIBLE SPIKED FEET	54
234RC	MONOPOD QUICK RELEASE TILT TOP	48
241	PUMP CUP	49
241FB	PUMP CUP WITH FLAT BASE	49
244ADAPT3814	3/8" AND 1/4" ADAPTERS	47
244ADAPT38AR	3/8" ANTI-ROTATION ADAPTER	47
244ADAPT58	5/8" ADAPTERS	47
244ADAPT-HS	HOT-SHOE ADAPTER	47
244MICRO	MICRO FRICTON ARM	46
244MICRO-AR	MICRO FRICTON ARM WITH ANTI ROTATION	46
244MICROKIT	MICRO FRICTON ARM WITH NANO CLAMP	46
244MINI	MINI FRICTON ARM	46
244RC	VARIABLE FRICTION ARM WITH QUICK RELEASE PLATE	47
319	100MM TO 75MM ADAPTER	51
323	RECTANGULAR VIDEO QUICK RELEASE ADAPTER	50
325N	VIDEO HEAD BOWL ADAPTER	51
357	ADAPTER	50
357PLONG	VIDEO CAMERA PLATE	50
357PLV	VIDEO CAMERA PLATE	50
386BC-1	NANO CLAMP	48
401N	QUICK ACTION STRAP	58
402	SHORT STRAP	58
492LCD	LCD MINI BALL HEAD	55
500BALL	100MM HALF BALL	51
500BALLSH	100MM SHORT HALF BALL	51
500HLV	PAN BAR	51
500PLONG	VIDEO CAMERA PLATE	50
501PL	VIDEO CAMERA PLATE	50
501PLONG	VIDEO CAMERA PLATE	50
502HLV	PAN BAR	51
504PLONG	VIDEO CAMERA PLATE	50
504HD	FLUID VIDEO HEAD - 75MM HALF BALL	12
504HD, 535K	VIDEO SYSTEM	13
504HD, 536K	VIDEO SYSTEM	13
504HD, 546BK	VIDEO SYSTEM	13
504HD, 546GBK	VIDEO SYSTEM	13
509HD	PRO FLUID VIDEO HEAD - 100MM HALF BALL	14
509HD, 536K	VIDEO SYSTEM	15
509HD, 545BK	VIDEO SYSTEM	15
509HD, 545GBK	VIDEO SYSTEM	15
509HLV	PAN BAR	51
509PLONG	VIDEO CAMERA PLATE	50
520BALL	75MM HALF BALL	51
520BALLSH	75MM SHORT HALF BALL	51
522AV	ADAPTOR CABLE FOR AV-R SONY CONNECTOR	45
522SCA	REMOTE CONTROL CABLE STANDARD	45
523RC	RAIN COVER FOR REMOTE CONTROL	45
526	PRO FLUID VIDEO HEAD - 100MM HALF BALL	16
526, 528XBK	VIDEO SYSTEM	17
526, 536K	VIDEO SYSTEM	17
526, 545BK	VIDEO SYSTEM	17
526, 545GBK	VIDEO SYSTEM	17
528XB	PRO HEAVY VIDEO TRIPOD	27
529B	HI-HAT	55
537SPRB	MID LEVEL SPREADER	54

Art. N°	Description	Page
535	MPRO CARBON FIBER 2-STAGE VIDEO TRIPOD	21
536	MPRO CARBON FIBER 3-STAGE VIDEO TRIPOD	21
537SPRB	MID LEVEL SPREADER	54
545B	PRO HEAVY-DUTY VIDEO TRIPOD	25
545GB	PRO HEAVY-DUTY VIDEO TRIPOD	25
546B	PRO VIDEO TRIPOD	26
546GB	PRO VIDEO TRIPOD	26
560B-1	FLUID VIDEO MONOPOD	29
560BALLSH	60MM HALF BALL	51
562B-1	FLUID VIDEO MONOPOD	29
565	SPIKED FOOT SHOES	54
577	VIDEO QUICK RELEASE ADAPTER	50
755CX3	MDEVE MAGFIBER VIDEO TRIPOD	19
755XB	MDEVE ALUMINUM VIDEO TRIPOD	19
MB MBAG100PN	100CM PADDED TRIPOD BAG	57
MB MBAG120PN	120CM PADDED TRIPOD BAG	57
MB MBAG70N	70CM UNPADDED TRIPOD BAG	57
MB MBAG80N	80CM UNPADDED TRIPOD BAG	57
MB MBAG80PN	80CM PADDED TRIPOD BAG	57
MB MBAG90PN	90CM PADDED TRIPOD BAG	57
MSTRAP-1	TRIPOD SHOULDER STRAP	58
MSTRAP-2	TRIPOD HANDLE STRAP	58
MVA060T	75MM TO 60MM ADAPTER	51
MVA500	EASY LINK CONNECTORS	34-49
MVA511WK-1	SHOULDER MOUNTED RIG	30
MVA514W	LENS SUPPORT	33
MVA517W	UNIVERSAL MOUNT	33
MVA518EXT	EXTENSIONS FOR HANDLES	32
MVA518W	ADJUSTABLE HANDLES	32
MVA519S	80MM H-OFFSET	33
MVA520	CONNECTORS FOR RODS	34
MVA520W-1	RODS - 300MM	34
MVA521	EXTENSION TUBES FOR COUNTERWEIGHT	35
MVA521W	COUNTERWEIGHT	35
MVA521L	LIGHT COUNTERWEIGHT	35
MVA523W-1	RODS - 150MM	34
MVA525W	RC2 MOUNT	32
MVA525WK	LIGHTWEIGHT SHOULDER MOUNTED RIG	31
MVDDA13	DIGITAL DIRECTOR FOR iPad Air	37
MVDDA14	DIGITAL DIRECTOR FOR iPad Air 2	37
MVH500A	FLUID VIDEO HEAD - 60MM HALF BALL	8
MVH500AH	FLUID VIDEO HEAD - FLAT BASE	8
MVH500AH, 755CX3	VIDEO SYSTEM	9
MVH500AH, 755XBK	VIDEO SYSTEM	9
MVH502A	FLUID VIDEO HEAD - 75MM HALF BALL	10
MVH502A, 546BK-1	VIDEO SYSTEM	11
MVH502A, 546GB-1	VIDEO SYSTEM	11
MVH502AH	FLUID VIDEO HEAD - FLAT BASE	10
MVK500AM	VIDEO SYSTEM	9
MVK500AQ	VIDEO SYSTEM	9
MVK500C	VIDEO SYSTEM	9
MVK502AM-1	VIDEO SYSTEM	11
MVK502AQ	VIDEO SYSTEM	11
MVK502C-1	VIDEO SYSTEM	11
MVK504AQ	VIDEO SYSTEM	13
MVM50A	FLUID BASE FOR MONOPOD	29
MVM250A	FLUID VIDEO MONOPOD	29
MVM500A	FLUID VIDEO MONOPOD WITH 500 HEAD	9-28
MVR901APCL	PAN BAR CLAMP ADAPTOR	45
MVR901ECEC	CLAMP-ON REMOTE CONTROL	43
MVR901ECLA	LANC REMOTE CONTROL	43
MVR901ECPL	CLAMP-ON REMOTE CONTROL	43
MVR901EPEX	PAN BAR REMOTE CONTROL	45
MVR901EPLA	PAN BAR REMOTE CONTROL	45
MVR911ECCN	CLAMP-ON HDLSR REMOTE CONTROL FOR CANON	38
MVR911EJCN	JOYSTICK HDLSR DELUXE REMOTE CONTROL FOR CANON	40
MVT502AM	TELESCOPIC-TWIN LEG TRIPOD	23
MVT535AQ	MPRO ALU 3-STAGE VIDEO TRIPOD	20
MVT535HH	HI HAT	55

Visit our blogs

manfrottoimaginemore.com

manfrottoschoolofexcellence.com

manfrotbags.com