

Kaiser General Catalogue 29



Kaiser Fototechnik
GmbH & Co. KG

Postfach 1262
74711 Buchen
Germany

Phone +49(0)6281-407-0

Fax +49(0)6281-407-55

www.kaiser-fototechnik.de
info@kaiser-fototechnik.de

Catalogue No. 29

Electrical appliances for mains operation are available for 120, 230 and 240 volts, if not indicated otherwise.

Specifications of some of the equipment manufactured for export may differ from the data quoted in this catalogue.

Some of the products in this catalogue are subject to distribution restrictions.

All Kaiser products have metric-system specifications. „Equivalents“ in English or American units of measure are approximate.

All information contained in this catalogue is subject to change without notice, i.e. texts and illustrations represent the production status at the time of printing. Scope of offer and specifications may be modified later.

Key to symbols



3454

Type and code number of required/recommended lamp or replacement lamp



Transformer required for operation



„Conformité Européenne/ European Conformity“: on all Kaiser products being subject to EU Directives to indicate conformity with Directives

© Kaiser Fototechnik 2013.
All rights reserved.

Photography:
Rudolph + Partner, Heilbronn
Imago, Wolfram Reiff, Heilbronn

Printing:
Laub GmbH, Elztal-Dallau

Printed in Germany 09010.02.0713.7500











Sought and Found

Bags	164, 165	Lens caps	152
Ball heads	168, 169	Lens hoods	150, 151
Blower bellows / Blower brushes	199, 200	Lenses, for enlargers	226
Book cradle / Book holder	105, 106	Light boxes	16, 115-122
Cable releases	156-159	Light stands	19, 53-56
Camera accessories	143-186	Light tents	17, 18
Camera bags	164, 165	Lighting kits	19, 34-37, 46
Camera lights	26-31	Lighting units	
Camera straps	160, 161	- for camera stands	66, 67, 69, 72, 77, 80, 82, 87, 88, 90, 91, 99, 100, 101, 103
Camera tripods	166, 167	- for shooting tables	11, 15, 18, 19, 21
Chemical storage bottles	236	Magnifiers	126, 127
Clamp-on lights	48	Masking frames	229, 230
Cleaning accessories	197-206	Memory card boxes	184
Cold light sources	50, 51	Monitor glare shields	146, 147
Compressed air can	22, 199, 231	Monopods	167, 172
Copy lighting units	66, 67, 69, 72, 77, 80, 82, 87, 88, 90, 91, 99, 100, 101, 103	Negative filing sheets	133
Copy stands	66-68, 71, 73, 74, 76, 79, 82, 84-86, 97, 99, 101, 103	Negative lab set	238
Copying accessories	63-108, 155	Photo functional gloves	163
Darkroom safelight	232	Quick-release connector	169
Desktop shooting kits	17	Remote flash triggers	176, 177, 180
Developing tanks	237	Remote releases	156-159, 176, 177, 180
Digital levels	108, 174	Ring lights	31
Enlarger components	218-228	Rodenstock filters	194, 195
Enlargers	211-219	Safety trimmers	139-142
Enlarging lenses	226	Scanning cameras	109-113
Exposure timer	232	Shooting tables	5-10, 12-14, 18, 20-21
Filing binder	133	Slide accessories	129-136
Filters, for cameras	187-195	Slide duplicator	155
Flash accessories	176-182	Soft lights	42
Flash triggers	176, 177, 180	SpeckGRABBER	204
Focusing stages	95, 99, 170	Spirit levels	108, 174, 175
Glare shields	146, 147	Studio lights	34-39, 41, 42, 44-46
Gloves	125, 163, 203, 205, 231	Table tripods	171
Halogen lights	29, 30, 34, 35, 38, 44-46, 49	Thermometers	233, 234
Handheld tripods	172, 173	Tiltall tripods, monopods, ball heads	166-168
Hinged brackets	59, 97	Trimmers	137-142
Kintronics cleaning accessories	204-206	Tripods	166, 167, 171-173
Lab accessories	207-240	Umbrellas	60, 61
Labelling pens	125	Video lights	26-30, 34-39, 42, 44-46
Lamp chart	241-243	Video transfer	186
Laser light pointer	136	White balance filters	153, 183
LCD accessories	145-149	Wrist straps	162
LCD screen glare shields	146, 147		
LCD screen protecting films	148, 149		
LCD viewfinder	145		
LED camera lights	26-28, 31		
LED light boxes	118, 119		
Lens accessories	150-155		

Not found?

See page 244

Contents

	Shooting Tables	5
	Lighting Units for Photo & Video	23
	Stands & Lighting Units for Image Capturing	63
	Scanning Cameras	109
	Light Boxes	115
	Print & Slide	123
	Trimmers	137
	Camera Accessories	143
	Filters	187
	Cleaning & Care	197
	Lab	207
	Lamp Chart / Index / Number Index	241

Shooting Tables



All dished up



Shooting tables are among the most convenient tools in photography, when photographing artistic set-ups or small objects. Professionals have long known this. The classic shooting table or a similar construction of stands, background paper and a horizontal board is part of their standard equipment.

Digital photography and its possibilities in particular make the benefits of a shooting table obvious. No matter if you want to document your teddy bear or model car collection, photograph expensive jewelry or precious coins for insurance purposes or need a quick picture for an internet auction - the shooting table provides support and background for the subject.

Shooting table - the very word makes you think of something bulky, furniture-like, complex and labor intensive. You will see, that this is not necessarily true.



Some problems do not even come up because of features and properties of the cameras. A zoom lens with macro setting is standard equipment for most of the digitals, the desired frame can be controlled with help of the camera monitor and nobody has to worry about parallax differences.

The concave shaped background is the most important part of a shooting table. It provides a transition from foreground to background without a visible edge. There are additional possibilities if the concave-shaped background is made of translucent material and is illuminated from the bottom and/or from behind. Light and lighting are always important as some subjects need effective lighting to bring out their features.

For the vast spectrum of tabletop photography Kaiser offers a variety of solutions to „dish up“: Fixed and portable units, for large or small, heavy or light subjects, variable system-based solutions with different components or complete units.

When your meal is dished up, everything should be nicely arranged. Why not do it the same way with your product shots and still lifes?



TopTable PRO – The Compact Studio

Tabletop photography on a professional level - that is what the TopTable PRO is designed for. In a floorspace of only 34 x 34 in. (85 x 85 cm) it offers a complete photographic studio with great versatility.

The secret of its success lies in its modularity: The shooting table forms a basic support that can be fitted with a concave curved acrylic-glass plate or a strong wooden board for heavy objects, and with a cardboard background.



To isolate objects entirely from any background, the basic table can also be fitted with a crystal-clear acrylic-glass add-on table.

There are also side mounting brackets which can be used to attach lighting units from the Kaiser camera stand range. The lights can also be positioned underneath the acrylic-glass plate for transmitted light shots.

The shooting table can be easily wheeled on its castors to any point without having to dismantle lights and stands and set them up again.





This is the regular set-up: Basic Support 5921 and Acrylic-Glass Plate 5924 are all you need for standard tabletop photography. In addition you may use paper background of any width as shown in the picture at the bottom.

There is a suitable set of Soft Lights 5867 available, that can be attached directly to the shooting table.



If photographed objects should appear to float in mid-air against the background, the Add-On Table 5922 is required.

As a matter of course other light sources (flash or continuous light, e.g. the provision Soft Lights, see page 42) can be positioned on suitable stands on both sides of the shooting table.



Some objects are too heavy, the acrylic-glass plate would bend under extreme load. That is why the Wooden Base Plate 5925 is available. The concave shaped background is formed by background paper of any desired width. The Background Carrier 5923 holds the background paper roll.

The Lighting Kit 5868 is mounted underneath the shooting table for transmitted light shots.





5921
Basic Support

Strong square tube frame fitted with height-adjustable feet at the front and lockable castors at the back. Mounting facilities for reflected and transmitted lighting.

Height: 1.78 m (70 in.)
Working height: 80 cm (31.5 in.)
Required floor space: 85 x 85 cm
(33.5 x 33.5 in.)

The „TopTable PRO“ main table consists of Basic Support 5921 and Acrylic-Glass Plate 5924.

5926
Mounting Adapter

To attach Kaiser lighting units (p. 77 and from p. 87) for reflective lighting to the Basic Support 5921. 2 pieces.

5924
Acrylic-Glass Plate

A white transparent background acrylic-glass plate that is mounted on the Basic Support 5921 to form a concave shaped base.

Width: 80 cm (31.5 in.)
Overall length: 168 cm (66.1 in.)
Thickness: 3 mm



5922
Add-On Table

Can be mounted on the basic table (consisting of the Basic Support 5921 and the Acrylic-Glass Plate 5924). The Add-On Table is supplied with a concave curved crystal-clear acrylic plate.

Dimensions (WxHxD): 85 x 102 x 80 cm
(33.5 x 40.2 x 31.5 in.)



5925
Wooden Base Plate

Can be mounted on the Basic Support 5921 (with or without Acrylic-Glass Plate 5924 attached). The matt grey laminated wooden plate is used in conjunction with paper background.

Dimensions: 85 x 56 cm (33.5 x 22 in.)

5923 Background Carrier

The carrier is mounted on the Basic Support 5921. Permits space-saving bearing of a background roll. Especially suited in combination with the Wooden Base Plate 5925.

Width: 85 cm (33.5 in.)



5867 Reflected Light Illuminating Set



5400K, 36W

5567

Is mounted to the Basic Support 5921. Consists of two softlights and holding rods with mounting adapters. Lights can be slid, pivoted and adjusted in height. Vertical holding rods have height marks and can be tilted to different angles. Fitted with two daylight fluorescents each, high-gloss inner finish and high-frequency operating system. Separate control box.

Lamps: 4 x 36 W
Color temperature: 5400 Kelvin
CRI: 90-100 (1A)
Reflector size: 50 x 21 cm (19.7 x 8.3 in.)



5868 Transmitted Light Illuminating Set



5400K, 36W

5567

Is mounted to the Basic Support 5921. Consists of two tiltable softlights, fitted with two daylight fluorescent lights each, high-gloss inner finish and high-frequency operating system. Separate control box.

Lamps: 4 x 36 W
Color temperature: 5400 Kelvin
CRI: 90-100 (1A)
Reflector size: 50 x 21 cm (19.7 x 8.3 in.)



5582 Filter Holders

Guiding rails for slide-in filters for attachment to Reflected Lighting Unit 5867 and Transmitted Lighting Unit 5868. 2 pairs.

5583 Diffusion Screens

Fine structure acrylic glass. Can be mounted in conjunction with Filter Holders 5582 to Lighting Units 5867 and 5868. 2 pieces.

5594 Polarizers

Can be mounted in conjunction with Filter Holders 5582 to Lighting Units 5867 and 5868. 2 pieces.

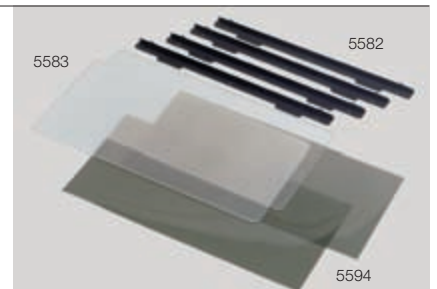

The Studio on Your Desk



„TopTable“ is a classic among the compact shooting tables. „TopTable“ is not only a modular system with various components, but also a compact unit with „desk-top size“ dimensions of 20 x 19“.

Whether used as a complete digital desktop studio or composed of different components to specific requirements: „TopTable“ copes with all problems of small object photography.

Product shots, catalog photos, internet pictures, creative stills, scientific photography, shots of medical preparations and instruments: possible fields of applications are only limited by the size of the subject.

Standard shooting situations with reflected light, silhouetting by background lighting, floating images, shots using a glass plate or a light tent – „TopTable“ will always provide a solution.

For more possibilities on desktop photography look at the products from page 17 on.

5993-96 Table-Top-Studio „digital”

Complete desktop studio consisting of Small Product Table 5931 and a lighting unit. Product table with white transparent concave shaped acrylic background. Required desk space approx. 50 x 50 cm (20 x 20 in.). Lighting unit consists of two small soft lights for even and smooth illumination. Holding rods with multiple orientation possibilities, screw-on clamps for attachment.

5994 and 5996 include an extra camera clamp comprising a 55 cm (21.7 in.) swan-neck arm for cameras up to 600 g (21 oz.), ball head with 30 mm (1.2 in.) base and 1/4” camera thread plus a universal desk clamp for boards up to 30 mm (1.2 in.) thick or tubes up to 55 mm (2.2 in.) diameter.

5993 Table-Top-Studio „digital SN-HF”

With RB 218N HF high-frequency daylight lighting unit (5464). Interior reflectors for high light output. Mains leads with cord switch.

Lamps: 2 compact fluorescent lamps, 18 W each, 5400 Kelvin, CRI = 90-100.

5994 Table-Top-Studio „digital SN-HF plus”

Same as 5993, but with camera clamp.

5995 Table-Top-Studio „digital LED”

With RB 5020 DS LED daylight lighting unit (5465).

With 192 white high-CRI LEDs per light. Lights can be continuously dimmed separately or in combination. Dimmer includes switch-off position. Colour temperature 5600 Kelvin, CRI > 85, angle of radiation: 60°.

5996 Table-Top-Studio „digital LED plus”

Same as 5995, but with camera clamp.





5930 TopTable-Set

Three-piece set made up with components of the "TopTable" small product table system. Consisting of basic table with transparent acrylic plate (5931), add-on table with clear acrylic plate (5932) and holding frame for accessories (5934).

5935 Base Stand

For Small Product Table (5931). Permits the use of different types of lighting set-ups or larger light troughs underneath the small product table.

Dimensions (WxHxD): approx. 510 x 310 x 480 mm (20.1 x 12.2 x 18.9 in.)

5931 Small Product Table

Compact product table for table-top photography and reproduction. Table top/background of transparent acrylic.

Dimensions (WxHxD): approx. 510 x 615 x 480 mm (20.1 x 24.2 x 18.9 in.)



5932 Add-On Table

Product table with clear acrylic plate to be set on the Product Table 5931 or to be used separately.

Dimensions (WxHxD): approx. 510 x 415 x 405 mm (20.1 x 16.3 x 15.9 in.)

5933 Glass Add-On Table

Flat product table for 5931 with glass top. Dimensions (WxHxD): approx. 510 x 160 x 405 mm (20.1 x 6.3 x 15.9 in.)

5934 Holding Frame

For holding foils, clamp-on lamp holders or similar accessories with the included holding clamps. Attaches to Product Table 5931 and 5932. Dimensions (WxD): approx. 510 x 480 mm (20.1 x 18.9 in.)

5465
RB 5020 DS TopTable Lighting Unit

LED daylight lighting unit comprising two small soft lights for even and smooth illumination, each equipped with 192 white high-CRI LEDs. Lights can be continuously dimmed separately or in combination. Dimmer includes switch-off position.

Lights are tiltable and adjustable in height. Angle of vertical arms adjustable by lock joint. Mounted with strong die-cast clamp bases. Clamping width up to 48 mm (1.9 in.).

Colour temperature: 5600 Kelvin

CRI > 85

Angle of radiation: 60°



5464
RB 218N HF TopTable Lighting Unit

Cold light lighting unit comprising two small soft lights, each equipped with a daylight fluorescent lamp. High frequency operating system. Main leads with cord switches.

Lights are tiltable and adjustable in height. Angle of vertical arms adjustable by lock joint. Mounted with strong die-cast clamp bases. Clamping width up to 48 mm (1.9 in.).

Lamps: 2 x 18 watt

Colour temperature: 5400 Kelvin

CRI = 90-100





2405/25
„prolite basic 2“ Soft Light Source

Light Box as a daylight type backlight source for „TopTable“ product table system.

Illuminated area: 50 x 30 cm (19.7 x 11.8 in.)

Lamps: 2 x 13 Watt, 5400 K

Dimensions (WxHxD): 562 x 60 x 364 mm
(22.1 x 2.4 x 14.3 in.)

„prolite basic 2 HF“ Soft Light Source (2425) with additional high-frequency operating system.



2136,
2476



5054
Camera Clamp

55 cm (21.7 in.) long gooseneck arm for cameras up to 600 g (21 oz.), ball head with 30 mm (1.2 in.) base and 1/4" camera thread. Universal table clamp with clamp range up to 30 mm (1.2 in.) on boards or 55 mm (2.2 in.) on tubes.



3439
Diffusing Foil

For producing soft, shadow-free illumination. Attaches to Holding Frame 5934 of „TopTable“ product table. Can be cut to required size.

Dimensions: approx. 60 x 760 cm
(23.6 x 300 in.)

5863-64 Desktop Shooting Kit

Comprehensive kit for object photography. Comprises a „Cube Studio“ light tent for even and soft light distribution and two lights on desktop stands.

Cube studio with detachable front cover with slot for camera lens and two reversible textile backdrops white/grey and black/blue. Easy to set up, folds up automatically. Can be folded down to compact size. Includes carrying pouch. Reflector lights with ceramic socket for photo-floods up to 250 watts (2 energy saving lamps, 25 W each, code no 3110, are included), swivel joint, umbrella mount and on/off switch. Detachable reflector, includes diffusing cover for soft light. Light stands with two-section telescopic center column, 16 mm standard spigot and 1/4" connection thread, setting height 35-70 cm (13.8-27.6 in.), max. load 3 kg (6.6 lbs.). Not available in 120 V.

5863: with Cube Studio 50 x 50 x 50 cm (20 x 20 x 20 in.) (5893)

5864: with Cube Studio 90 x 90 x 90 cm (35 x 35 x 35 in.) (5894)



5893-94 Cube Studio Light Tent

Cube-shaped light tent for even and soft illumination when shooting small objects. Detachable front cover with slot for camera lens. Easy to set up, folds up automatically. Can be folded down to compact size.

Includes two reversible textile backdrops white/grey and black/blue and zippered carrying pouch with wrist strap.

5893: 50 x 50 x 50 cm (20 x 20 x 20 in.)

5894: 90 x 90 x 90 cm (35 x 35 x 35 in.)

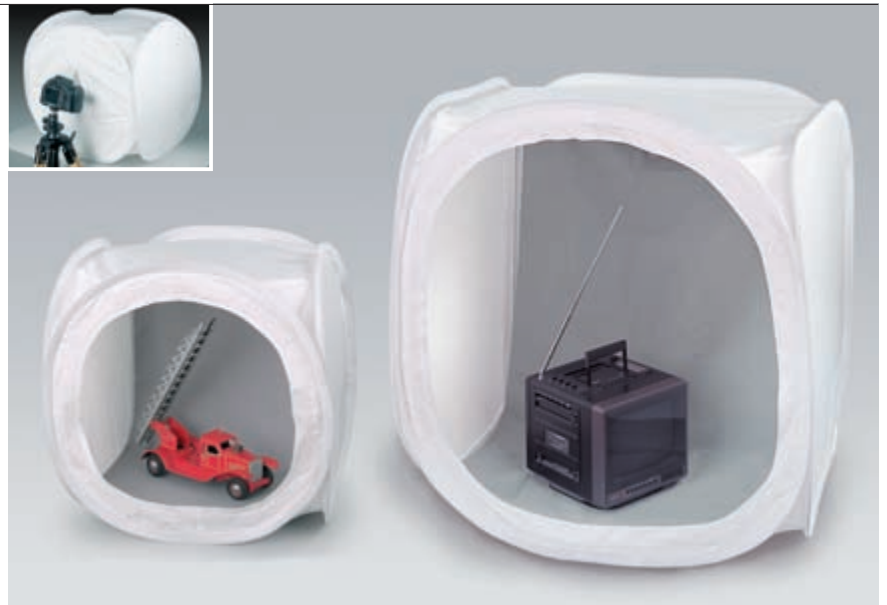



5891-92
„Dome Studio“ Light Tent

For small object photography. Suitable for product shots and internet images. White translucent surfaces provide for even and soft illumination. Umbrella-type construction makes set-up and fold-down easy. Comes with reversible textile background (white and grey) and protective cover with carrying straps.

5891: Floor size: 62 x 62 cm (24.5 x 24.5 in.), height: 51 cm (20 in.)

5892: Floor size: 75 x 75 cm (29.5 x 29.5 in.), height: 65 cm (25.5 in.)



5875-76
„ConCave“ Background

Flat and flexible plastic plate with holes on both sides and tightening cord. The plate can be bent in the desired shape and then be fixed by means of two „beads“ and choice of respective holes. Dimensions of flat plate: approx. 60 x 30 cm (23.6 x 11.8 in.)

5875: Opaque plate for shooting with reflected light.

5876: Transparent plate, for shooting with reflected and backlight.

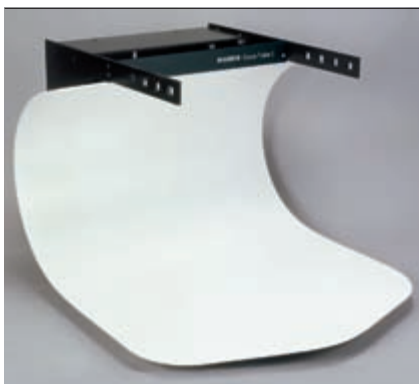

5883
„Open Tube 1“ Shooting Table

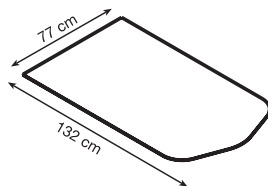

This shooting table is pre-tailored from one single press board and is assembled by the user. The background made of flexible plastic material is inserted into the assembled table and fixed by velcro fittings. The evenly curved background („open tube“ outline) improves the distribution of light on the subject.

Side frames of the table provide attachment points for one or more lighting modules in vertical or horizontal position.

Dimensions (WxHxD, incl. background): 77 x 60 x 84.5 cm (30.3 x 23.6 x 33.3 in.)



5884
Lighting Module



5567

For 5883. One or more modules can be attached in horizontal or vertical position.

Aluminum housing with interior reflector, equipped with 36 watt daylight fluorescent lamp and high-frequency ballast. Mains lead with cord switch.

Reflector size: approx. 45 x 6.4 cm (17.7 x 2.5 in.)

5861-62 Desktop Lighting Kit



3110 3130
3124 4356
3128

For still life and small product photography, e.g. in connection with shooting tables and light tents.

5861 Desktop Lighting Kit 1

Comprises reflector light for photofloods up to 250 W, with E27* ceramic socket, detachable reflector (ø 27 cm/10.6 in.), swivel joint, umbrella mount and on/off switch. Cord length approx. 3.8 m (12.5 ft.). Removable diffusing cover for soft light and desktop light stand 5859. Supplied with energy saving lamp 3110 (with 230 V version).

5862 Desktop Lighting Kit 2

Comprises 2 Desktop Lighting Kits 1 (5861).



5860 Lamp Holder



3128

Suitable for photofloods up to 250 W max. With E27* ceramic socket, swivel joint, umbrella mount and on/off switch. Mounts on suitable tripods/stands with 16 mm standard spigot. Supplied without lamp.

Mains cord: approx. 3.8 m (12.5 ft.)



3110 Energy Saving Lamp

Daylight lamp with E27 socket. 25 watt, 6400 Kelvin, 1400 lumen, 230 volt. Start-up time < 2 sec. Service life up to 8000 hours.

Length: 158 mm (6.2 in.), diameter: 59 mm (2.3 in.)

See page 47 for more lamps.



5858-59 Desktop Light Stand

Two-section telescopic center column. 16 mm standard spigot and 1/4" connection thread. Max. load: 3 kg (6.6 lbs.)

5858: Setting height: approx. 22-38 cm (8.7-15 in.)

Length closed: approx. 24.5 cm (9.6 in.)

Weight: approx. 340 g (12 oz.)

5859: Setting height: approx. 35-70 cm (13.8-27.6 in.)

Length closed: approx. 39 cm (15.4 in.)

Weight: approx. 530 g (18.7 oz.)



Studio-out-of-the-Box



Since photography has become digital, more and more pictures of small objects are taken, included on web-sites to improve offering with internet auctions or to digitally archive collections. More and more images are also included with e-mails.

Studio-out-of-the-Box was designed to be a multiple problem solver: Camera mounting, object positioning and background are handled "out-of-the-box", and as an accessory there is also a lighting solution.

All will fit on your living room table - or wherever you want to place your temporary studio. Studio-out-of-the-Box is primarily a 30 x 45 cm / 12 x 18"

open-profile baseboard with a drawer and with a smart trapeze stand snuggling outside the baseboard. This makes it possible to fold it resulting in a rather compact unit that fits in the box.

The object is placed on the baseboard, the drawer holds a frame that unfolds to carry the included background roll. The background roll is only supported by the frame and that makes it easy to use wider backgrounds. If the drawer is removed completely and turned upside down, it increases the length of the studio base by 30 cm/12".

Opening the trapeze stand reveals its function: a camera mounted on the pivotable and relocatable platform can be positioned at any angle, any height and various distances from the object. The trapeze stand can be easily adjusted and holds the camera in any position. When shooting vertically from a top-down position the camera platform can be locked by two sliding guide bars in a way that the vertical position will remain as the trapeze is rotated.

An optional lighting unit can easily be attached to the main table and will also fit in the box.

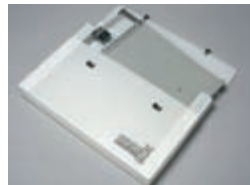

5911 Studio-out-of-the-Box

Compact foldable studio for digital photography. Comprises table, background support, background material and trapeze stand for cameras up to 500 grams.

On the trapeze stand the camera can be positioned in many different positions and in different height and distance from the object. The camera platform is pivotable and relocatable and can be locked for vertical shooting position. Suitable for almost all digital compacts.

Table can be extended, background can be positioned in different heights. Background roll included, approx. 40 cm (15.7 in.) wide and 130 cm (51.2 in.) long. To support wider backgrounds a clip-on rail is included.

Dimensions (folded):
585 x 57 x 330 mm (23 x 2.2 x 13 in.)

Supplied with carrying box:
605 x 485 x 100 mm (23.8 x 19.1 x 3.9 in.)
(without handle)



5914 Studio-out-of-the-Box Lighting Set

Contains two lights, adjustable in height, pivotable and tiltable, mounted on tilting holding arms. High frequency operation with integrated electronic ballasts.

On/off switch on housing.

Lamps: 2 x 8 watts, approx. 4000 Kelvin, approx. 5000 hours service life.

Mains lead: 2 x 1.9 m (6.2 ft.)



5909/2133 Replacement Lamp

For 5914.

5909: Fluorescent lamp, 8 watts, approx. 4000 K, approx. 5000 hours service life. 1 piece.

2133: Fluorescent lamp, 8 watts, approx. 5400 K, approx. 8000 hours service life. 1 piece.)





6308-10
„Clear Gear“ Compressed Air

For touch-free dust removal from optical, fine mechanical and electronic equipment and components. With spray valve and capillary tube for inaccessible places.

6308: „Clear Gear“ compressed air can, 200 ml, propane/butane mixture.

6309: „Clear Gear“ compressed air can, 400 ml, non-inflammable fluorethane mixture, special high pressure version.

6310: „Clear Gear“ compressed air can, 400 ml, propane/butane mixture, special high pressure version.



6381
Matt Spray

To remove undesirable reflections on shiny surfaces such as enamel, glass, plastic, high-gloss paint, chrome, etc. The photo matt spray is transparent, produces an even matt finish, dries quickly, adheres well and can be easily removed with water.

400 ml can.



6388
Adhesive Paste

Permanently elastic putty for holding, supporting and arranging photo objects. The putty can be formed at will and sticks to the object. It can be removed without leaving any residue.

Package with 250 g (8.8 oz.)



6678
„Xerapol“ Acrylic Glass Polish

Polish paste for removal of scratches from acrylic glass, e.g. at shooting tables or light boxes. For more information see page 203.

6679
Acrylic Glass Cleaner

Special cleaning spray for acrylic glass. Supplied in pump spray bottle. For more information see page 203.



**Lighting Units
for Photo & Video**

All-Purpose Light



Light is indispensable for the „photographic“ vision. If natural light is not sufficient or does not lead to the desired result, „artificial“ light sources come into operation.

But the nature of this light is no longer „artificial“. There are many light sources that provide daylight or can be adapted to daylight. The features and possibilities of digital cameras allow for an adaptation to „natural light conditions“.



When shooting specific objects the requirements for lighting may be complete opposites.

Light can be soft and even sometimes, while it can be harsh and strong other times, should avoid shadows or create shadows, should highlight edges or avoid reflections, should be directed to places difficult to access, should eventually be heat free or be „subject-friendly“ in other ways - the list of requirements could go on and on.

The lamps themselves - their size, shape and technology - as well as the lighting units they are used in, determine one part of the illumination result, the other part is controlled by the position and the set-up of the lights, and is therefore based on the knowledge and skills of the „lighting technician“.

Lights mounted directly on the camera are normally portable, have their own power supply, are compact and lightweight. For studio or „on location“ use suitable lights are mounted on light stands or other fixtures.

Camera Light

Most cameras come with an integrated „always at hand“ flashlight. Advanced models – however – still have a hot shoe to connect a more powerful flashgun. These cameras can also shoot videos – and that is why they need continuous light, just like camcorders.

Camera lights should be as small and as lightweight as possible, should have their own power supply and should provide plenty of light for a long period of time. Today's modern LED lights can meet these requirements, provided that the LEDs are selected for use in a photographic application. That is why the lights described on the following pages are all equipped with LEDs suitable for photo and video with regard to angle

of illumination, performance properties and color characteristics.

If even more power and operating distance is required, the established halogen lights will do the job.





3260 „L2S-5K“ LED Camera Light

Compact LED soft light for photo and video, especially useful when shooting videos with DSLR and CSCs.

7.5 x 5 cm (3 x 2 in.) panel with 96 three-chip LEDs, 5400 Kelvin colour temperature (daylight), continuously dimmable. Extremely wide angle of radiation (half-value angle) of 110 degrees. Built-in blower cooling to provide for an optimum ambient temperature essential for efficient LED performance. Blower speed controlled automatically and temperature-dependent or manually in five levels. Rear LCD displays blower speed and dimmer position.

LED panel can be removed and exchanged for a 3200 Kelvin panel (accessory). Battery compartment for standard Sony L-type (NP-F) battery. Connection for external power source.

Electronically stabilized light output keeping the illuminance constant when supply voltage goes down. Automatic shutdown when batteries are exhausted to prevent deep discharge and battery defects.

Illuminance: 380 lux at 1 m (3 ft.) and 110° half-value angle

Colour rendition index: CRI > 90

Colour temperature: 5400 Kelvin

Operating time with fully loaded battery: approx. 45 minutes

Operating voltage: 6-17 V

Dimensions of light head: 93 x 75 x 43 mm (3.7 x 3 x 1.7 in.)

Weight: approx. 200 g (without battery)

Tripod thread: 1/4"

Lithium ion battery: 7.2 V, 2200 mAh

Supply includes a honeycomb filter for more directional light, battery, charger, ball head for mounting the light to the camera's accessory shoe and a Sony/Minolta accessory shoe adapter.



3261

3261 Artificial Light Panel for „L2S-5K“ LED Light

3200 Kelvin, can be exchanged for the standard daylight panel of the L2S-5K light.

3255 „L10S-5K“ LED Camera Light

Compact LED soft light for photo and video, especially useful when shooting videos with DSLR and CSCs.

7.5 x 5 cm (3 x 2 in.) panel with 96 three-chip LEDs, 5400 Kelvin colour temperature (daylight). Brightness can be adjusted either via the control on the back or the 3256 IR remote available as an accessory. Rear LCD displays dimmer position. Convective cooling via large built-in heat sink. Battery compartment for standard Sony L-type (NP-F) battery. Connection for external power source. Electronically stabilized light output keeping the illuminance constant when supply voltage goes down. Automatic shutdown when batteries are exhausted to prevent deep discharge and battery defects.

Illuminance: 380 lux at 1 m (3 ft.) and 110° half-value angle

Colour rendition index: CRI > 90

Colour temperature: 5400 Kelvin

Operating time with fully loaded battery: approx. 50 minutes

Operating voltage: 6-17 V

Dimensions of light head: 93 x 83 x 25 mm (3.7 x 3.3 x 1 in.)

Weight: approx. 190 g (without battery)

Tripod thread: 1/4"

Lithium ion battery: 7.2 V, 2200 mAh

Supply includes a honeycomb filter for more directional light, battery, charger, ball head for mounting the light to the camera's accessory shoe and a Sony/Minolta hot shoe adapter.

3256 IR Remote Control

For L10S-5K camera light. Allows for adjusting the brightness from distances up to 10 m (30 ft.). 8 channels can be selected.

3263 Mains Power Adapter

Power supply unit for operating the L2S-5K and L10S-5K on the mains.

Stabilized output voltage and short circuit proof. Comes with exchangeable plug adapters and several output connectors.

Input voltage: AC 100-240 V, for world wide use
Output voltages: DC 3 / 4.5 / 5 / 6 / 7.5 / 9 / 12 V
Maximum output current: 1500 mA





3270 „StarCluster“ LED Camera Light

Compact LED soft light for photo and video, especially useful when shooting videos with DSLRs and CSCs.

8.5 x 6 cm (3.3 x 2.4 in.) panel with 96 white High-CRI-LEDs, 5600 K colour temperature (daylight / neutral colour rendition), continuously dimmable. 600 lux illuminance at 1 m (3 ft.) distance and 60° angle of radiation (half-value angle). Crystal clear protective screen. Magnetic fixtures for diffuser screen and artificial light filter for conversion to 3200 K (both included). Power supply by five standard AA batteries or rechargeables housed in the rear battery compartment. Can also be powered by a Canon LP-E6 battery (standard battery of EOS 5D MK II/III, 6D, 7D and 60D) attached on the rear side. Terminal for mains adapter.

Electronically stabilized light output keeping the illuminance constant when supply voltage goes down. Automatic shutdown when batteries are exhausted to prevent deep discharge and battery defects.

Several lights can be combined side by side or on top of each other by a special catching system. 1/4" tripod thread. Continuously adjustable swivel joint with standard foot for accessory shoe and tripod thread.

Illuminance: 600 lux (1 m, $\lt; 60^\circ$)
Colour rendition index: CRI > 85
Colour temperature: 5600 K
Operating time with fully loaded batteries: 2.5 hours max.
Operating voltage: 5.8 - 16.8 V
Dimensions of light head: 127 x 77 x 45 mm (5 x 3 x 1.8 in.)
Weight: 195 g (6.9 oz.) (without batteries)
Scope of supply: light, diffuser, artificial light filter, swivel joint (w/o batteries)

3271 Mains Power Adapter

Power supply unit for operating a "StarCluster" LED camera light (3270) or a R48 ring light (3248) on the mains.

3288 „camlight Nova“ Video Light

Compact camcorder light with 20 watt halogen lamp. Specially designed reflector for even illumination. 3200 K colour temperature. Slide-in foot for upright or horizontal mounting, with blocking screw and 1/4" tripod thread.

Powered by regular NiMH rechargeables (5 x AA, not included). Operating time up to 40 minutes. Battery compartment inside light housing.

On/Off switch.

Mounting bracket 1108 included.

Dimensions: (WxHxD): 55 x 98 x 72 mm
(2.2 x 3.9 x 2.8 in.)

Weight: 110 g (3.9 oz.) (without batteries)

1108 Universal Accessory Bracket

Two-part angle bracket for mounting accessories such as flashguns, lights, microphones, GPS logger etc. on cameras and camcorders. The bracket can be aligned to the camera in different ways.

Bracket mounts to the tripod thread of the camera. Mounting screw has male and female 1/4" threads and removable securing pin.



3027



1108

93296 Accessory Bracket

For raised mounting of a light, microphone etc. next to the camcorder lens. Folding. With antitwist pin for exact right-angled mounting on camcorder. Widened three-point rest on bottom side. Camera with mounted bracket stands firmly on all flat surfaces.

1/4" tripod thread.



93296



3288
with 1108



3288 with 1108



3028

3054



93324

93310 „camlight 100“ Video Light

Compact safety lighting unit for battery operation. Front attachment with light flaps and safety glass. Heat-resistant reflector housing can be swivelled up to 90° upwards for indirect lighting. Adjustable angle of light escape (variable focussing). Accessory shoe for mounting to camera. 1/4 " tripod thread. On/off switch. Power pack with lamp holder and maintenance-free lead acid battery. Operating time approx. 25 min. under full load. Can also be operated with 50 W lamp for approx. 50 min. Battery charge indicator (LED). Charging time max. 14 hours depending on degree of discharge. Complete with charger.

Technical specifications of lamp:

Operating voltage: 12 V
 Halogen lamp: 100 W, 3200 K
 Cord: spiral cord, max 1.5 m (5 ft.)
 Weight: approx. 485 g (1.1 lbs.)
 Dimensions: approx. 60 x 120 x 90 mm
 (WxHxD) (2.4 x 4.7 x 3.5 in.)

Technical specifications of battery:

Rated capacity: 6.5 Ah
 Weight: approx. 3000 g (6.6 lbs.)
 Dimensions: approx. 175 x 150 x 71 mm
 (WxHxD) (6.9 x 5.9 x 2.8 in.)

93339 „camlight 100“ Video Light

With 100 watt, 3200 Kelvin halogen lamp. For 12 V battery operation. Cable with XLR connector. Supplied without batterie.

93313 PP 100 Power Pack

12 V/6.5 Ah lead acid battery for „camlight 100“. Also suitable for other 12 V units with XLR connector.

93314 Charger

For PP 100 Power Pack.

93324 Conversion Filter

Safety front attachment with conversion filter for „camlight 100“ (93310/93339).

3248 R48 Ring Light

LED ring light for shadowless illumination in close-up and macro photography. 48 white LEDs, daylight balanced at 6000 K +/- 500 K. Light mounts on the lens via appropriate adapter ring. Supplied with six adapter rings for filter threads of 49/52/55/58/62/67 mm. Power supply by two AA batteries/rechargeables housed in a separate battery compartment or from the mains via optional mains power adapter 3271 (description see page 28).

Left side and right side LEDs can be switched separately.

Minimum working distance: 3 cm (1.2 in.)
Operating time with two nickel metal hydrides: approx. 2.5 hours
Dimensions: Ring light 13 x 11 x 3 cm (5.1 x 4.3 x 1.2 in.), battery compartment: 9 x 5 x 5 cm (3.5 x 2 x 2 in.)
Weight: Ring light incl. adapter ring: approx. 140 g (4.9 oz.), battery compartment, without batteries: approx. 55 g (1.9 oz.)



3250 KR 90 Ring Light

Professional ring light with 30 three-chip high performance LEDs. The light intensity corresponds to that of a 30 watt fluorescent light. Extremely wide angle of radiation of 110° (half-value angle). A rechargeable lithium-ion battery and the complete circuitry are integrated in the main body made of highly durable duralumin. Light can be dimmed down. The basic connection thread is 77 mm, several adapter rings from 55 to 72 mm are included. Light can also be mounted on a tripod. No illuminance drop-off due to battery consumption. Automatic shutdown when batteries are exhausted to prevent deep discharge and battery defects. Supply includes quick charger and car charger cable.

Min. working distance: 3 cm (1.2 in.)
Operating time: approx. 2 hours
Colour temperature: approx. 5500 K
Battery capacity: 1500 mAh
Tripod thread: 1/4"
Dimensions: ø 142 x 34 mm (ø 5.6 x 1.3 in.)
Weight: 300 g (10.6 oz.)



Fixed Continuous Light



For lighting in the studio or “on location” there is the general choice between flash and continuous light.

Using flash makes high demands on the experience of the photographer. With continuous light sources as presented in this catalog the illumination can be evaluated precisely before shooting, because set-up and shooting use the same light.

Soft Lights normally provide for very soft and even lighting. They are especially useful with object photography with shadowless illumination. They are equipped with daylight-type fluorescent lamps and are often high-frequency operated, therefore suitable to be used with all kinds of cameras.

Their light is cool so there is only a minor thermal load on the object. All this, together with the long service life of fluorescent lamps, allows for extended operating times and long shooting sessions and therefore high performance. Color rendition remains constant over a long period of time and power consumption is rather low.

Halogen lights have high light output and can cover wide spaces. Their light is harsh and contrasty and you can deliberately intensify contrast and shadows. In addition their light is „hot“. That is why in most cases lighting units are equipped with an extra cooling fan.





Close-up photography and photomicrography are the application fields of **cold light sources** using flexible fiber-optic light guides to get light exactly to a specific area.

Halogen lighting units though are very compact and light-weight, they are easy to carry.

Lamps with screw-in thread, commonly known as photofloods, have been around for many years. They are used in **reflector lights**, the reflector itself can be fixed or exchangeable. The character of illumination is determined by the shape and the surface of the reflector.

The universal E27 screw-in socket accepts a variety of lamps: traditional photofloods, halogen lamps and fluorescent lamps.

If you have to photograph very small objects, **halogen spots** are extremely useful. They can be targeted to the object or just a part of it with the help of flexible gooseneck arms.





 1000W 3400K 3075
 1000W 3200K 3094

3165 „studiolight 1010“ Lighting Kit

Lighting system for still life, portrait, video and movie shots.

Consisting of

2 „studiolight 1010“ halogen lighting units (3164), each with 1000 Watt halogen lamp and protective lamp cover made of safety glass. Brightness can be adjusted via step-up/step-down buttons. Low-noise blower cooling. Bayonet attachment with quick locking device for accessories. With swivel joint, umbrella mount and exchangeable reflector \varnothing 180 mm (7.1 in.) and protective lamp cover,

2 heat resistant soft boxes 60 x 90 cm (23.6 x 35.4 in.) and

2 air-cushioned light stands (setting height 75-230 cm / 29.5-90.6 in.)

Comes in a sturdy carrying case (3166) with carrying handle and shoulder strap.

Outside dimensions: approx. 73 x 28 x 44 cm (28.7 x 11 x 17.3 in.)



3166

3166 Carrying Case

Sturdy and inherently stable carrying case with space for two studio lights with standard reflector, two umbrellas or soft boxes, two light stands and small accessories. Two dividers, removable intermediate base, mesh pocket on inside lid, carrying strap with non-slip shoulder pad, handle.

Outside dimensions: approx. 73 x 28 x 44 cm (28.7 x 11 x 17.3 in.)

3157 „studiolight H trio“ Lighting Kit

Portable lighting system for product shots, portrait, video and film.

Contains:

3 „studiolight H“ halogen lighting units (3152), each with 1000 W halogen lamp and safety glass bulb dome, dimmer, low-noise cooling fan, front part with bayonet attachment for accessories, swivel joint, detachable reflector (180 mm / 7.1 in. diameter) and protective lamp cover,

2 heat resistant soft boxes 60 x 60 cm (23.5 x 23.5 in.) (3177) and

3 air-cushioned light stands (setting height 70-230 cm / 27.6-90.6 in.).

In a sturdy trolley for transportation and storage, with plastic casters and pedestals, telescopic handle, two carrying handles and adjustable padded shoulder strap. Main compartment with adjustable dividers.

Outside dimensions: approx. 88 x 46 x 35 cm (34.6 x 18.1 x 13.8 in.)



3075

3094





3124-3130

3156



3154

3156/3154 „studiolight C“ Lighting Kit

Portable lighting system for product shots, portraits, video and movie shots.

3156 „studiolight C trio“ Lighting Kit

Contains:

3 „studiolight C“ lighting units (3150), each with E27 screw-in socket* for photofloods up to 500 watt, low-noise cooling fan, front part with bayonet attachment for accessories, swivel joint, detachable reflector (180 mm / 7.1 in. diameter), 150 watt lamp (3124) and protective lamp cover,

1 silver reflector umbrella (100 cm / 39.4 in. diameter),

1 transmitted light umbrella (100 cm / 39.4 in. diameter) and

3 air-cushioned light stands (setting height 70-230 cm / 27.6-90.6 in.).

In a sturdy trolley for transportation and storage, with plastic casters and bumpers, telescopic handle, two carrying handles and adjustable padded shoulder strap. Main compartment with adjustable dividers.

Outside dimensions: approx. 88 x 46 x 35 cm (34.6 x 18.1 x 13.8 in.)

3154 „studiolight C Kit“ Lighting Kit

Contains:

2 „studiolight C“ lighting units (3150), each with E27 screw-in socket* for photofloods up to 500 W, low-noise cooling fan for unlimited operation, front part with bayonet attachment for accessories (reflectors, soft boxes), swivel joint with locking lever, umbrella mount, protective lamp cover, 150 W photoflood (3124) and exchangeable reflector (180 mm/7.1 in. diameter),

1 silver reflector umbrella (100 cm / 39.4 in. diameter),

1 transmitted light umbrella (100 cm / 39.4 in. diameter) and

2 air-cushioned light stands (setting height 70-230 cm / 27.6-90.6 in.).

In a sturdy carrying case with handle and padded shoulder strap.

Case dimensions: approx. 94 x 30 x 27 cm (37 x 11.8 x 10.6 in.)

* 120 V version has E26 screw-in socket

3168 „studiolight 510 Kit“ Lighting Kit

Portable lighting system for product shots, portraits, video and movie shots.

Contains:

2 „studiolight 510“ lighting units, each with E27 screw-in socket* for photofloods up to 500 watt, front part with bayonet attachment for accessories, swivel joint, detachable reflector (210 mm diameter / 8.3 in.), 150 watt lamp (3124) and protective lamp cover,

1 silver reflector umbrella (100 cm / 39.4 in. diameter),

1 transmitted light umbrella (100 cm / 39.4 in. diameter) and

2 light stands (setting height 70-190 cm / 27.6-74.8 in.).

In a carrying case with handle and non-slip shoulder strap.

Outside dimensions: approx. 83 x 24 x 33 cm (32.7 x 9.4 x 13 in.)

* 120 V version has E26 screw-in socket





3164 „studielight 1010“ Lighting Unit

Compact unit for continuous lighting for product shots, portrait, video and movie shots.

With 1000 W halogen lamp and safety glass bulb dome. Light output can be dimmed steplessly via step-up/step-down buttons and switched over to maximum output and back. Digital display. Low-noise cooling fan for unlimited operation. Front part with bayonet attachment for accessories (reflectors, soft boxes), swivel joint with locking lever, umbrella mount. Mounts on suitable tripods/stands with 16 mm standard spigot. Includes halogen lamp, exchangeable reflector (180 mm / 7.1 in. diameter) and protective lamp cover.

Halogen lamp: 1000 W, 3400 K

Fuse: F 6.3 A (for 220 - 240 V)

F 10 A (for 120 V)

Lead: approx. 3.5 m (11.5 ft.)

Weight with reflector: approx. 1580 g (3.5 lbs.)

Dimensions with reflector: approx. 310 x 190 x 260 mm (12.2 x 7.5 x 10.2 in.)



3075

3094



3150 „studiolight C“ Lighting Unit

Compact unit for continuous lighting for product shots, portrait, video and film.

E27 screw-in fixture for photofloods up to 500 W. Low-noise cooling fan for unlimited operation. Front part with bayonet attachment for accessories (reflectors, soft boxes), swivel joint with locking lever, umbrella mount. Can be mounted on suitable tripods/stands with 16 mm standard spigot.

Includes exchangeable reflector (180 mm / 7.1 in. diameter), protective lamp cover and 150 W photoflood (3124).

Socket: E27 (120 V: E26)
Fuse: F 4 A (for 230/240 V), F 10 A (for 120 V)
Lead: approx. 4 m (13 ft.)
Weight with reflector: approx. 1820 g (4 lbs.)
Dimensions without reflector: approx. 210 x 120 x 240 mm (8.3 x 4.7 x 9.4 in.), with reflector: approx. 360 x 180 x 260 mm (14.2 x 7.1 x 10.2 in.)



3124-3130

3162-63 Carrying Case/Trolley

3162: Carrying Case

Sturdy carrying case with space for two studio lights with standard reflectors, two umbrellas or soft boxes, two light stands and small accessories. Four dividers. Zipped mesh pocket on inside lid. Padded shoulder strap, handle.

Outside dimensions: approx. 94 x 30 x 27 cm (37 x 11.8 x 10.6 in.)

3163: Trolley

Rugged trolley for carrying and storage of three studio lights with standard reflector, two umbrellas or soft boxes, three light stands and small accessories. Three dividers, large zipped mesh pocket on inside lid. Plastic wheels and bumpers, telescopic handle, two carrying handles and adjustable carrying strap with shoulder pad.

Outside dimensions: approx. 88 x 46 x 35 cm (34.6 x 18.1 x 13.8 in.)





3177-78
Soft Box

Attaches to studiolight 1010, studiolight H, studiolight C and studiolight 510.

Can be rotated and locked. Made of heat-resistant materials. With four ventilation flaps.

3177: 60 x 60 x 35 cm
(23.5 x 23.5 x 13.8 in.)

3178: 100 x 100 x 40 cm
(39.5 x 39.5 x 15.7 in.)



3159
Interchangeable Reflector 275 mm

Attaches to studiolight 1010, studiolight H, studiolight C and studiolight 510.

Narrow beam. Silver coating inside. Matte black coating outside.

Diameter: approx. 275 mm (10.8 in.)
Depth: approx. 190 mm (7.5 in.)



3160
Interchangeable Reflector 420 mm

Attaches to studiolight 1010, studiolight H, studiolight C and studiolight 510.

Wide beam. Silver coating inside. Matte black coating outside.

With secondary reflector for even illumination and reduced glare. Removable heat-resistant fabric diffuser.

Diameter: approx. 420 mm (16.5 in.)
Depth: approx. 150 mm (5.9 in.)



3170
Background Reflector

Attaches to studiolight 1010, studiolight H, studiolight C and studiolight 510.

45° angle. Silver coating inside. Matte black coating outside.

Can be rotated and locked in any position.

Diameter: approx. 330/210 mm (13 / 8.3 in.)
Depth: approx. 350/100 mm (13.8/3.9 in.)

3140 Studio Light

Reflector light for photofloods up to 250 W, with E27* ceramic socket, detachable reflector (ø 27 cm / 10.6 in.), swivel joint, umbrella mount and on/off switch, cord length approx. 3.8 m (12.5 ft.). Includes removable diffusing cover for soft light.

Supplied without lamp.

* 120 V version has E26 screw-in socket



3110 3130
3124 4356
3128



5860 Lamp Holder

Suitable for photofloods up to 250 W max.

With E27* ceramic socket, swivel joint, umbrella mount and on/off switch. Mounts on suitable tripods/stands with 16 mm standard spigot. Supplied without lamp.

Mains cord: approx. 3.8 m (12.5 ft.)

* 120 V version has E26 screw-in socket



3128





„proVision“ Soft Light

For even and soft illumination, especially suitable for digital photography and video shooting.

Fitted with 55 watt daylight fluorescents with very low heat radiation. High-frequency operating system (approx. 40 kHz) for immediate ignition and flicker-free operation for unrestricted use with all digital camera systems including scanning cameras and scan-backs. High-gloss reflectors and intensifier barn doors for exceptionally high lighting efficiency. Light output can be dimmed down to 10% of maximum. Compact aluminum housing. Light is tiltable, with mounting frame for suitable stands/holding devices with 16 mm standard spigot.

Color temperature: 5400 K (3200 K on request)

Service life of lamps: approx. 8000 h

CRI: 90-100

3431 proVision 6.55 HF

Lamps: 6 x 55 watt, 5400 K
4 barn doors, cable remote control (3 m/ 10 ft.) for dimming.
Illuminating surface: 51 x 51 cm (20 x 20 in.)
Weight: 8.6 kg (18.9 lbs.)

3428 proVision 4.55 HF

Lamps: 4 x 55 watt, 5400 K
4 barn doors, cable remote control (3 m/ 10 ft.) for dimming.
Illuminating surface: 34 x 51 cm (13.4 x 20 in.)
Weight: 6.7 kg (14.8 lbs.)

3425 proVision 2.55 HF

Lamps: 2 x 55 watt, 5400 K
2 barn doors, dimmer on lighting unit.
Illuminating surface: 17 x 51 cm (6.7 x 20 in.)
Weight: 4.4 kg (9.7 lbs.)

3454/64 Fluorescent Lamp

Replacement lamp for 3425/3428/3431.
1 piece.

3454: 55 W, light color 12, approx. 5400 K

3464: 55 W, light color 32, approx. 3200 K



3413-15
Diffusion Screen

For use with „proVision“ soft lights.
Prismatic surface. 1 piece.

3413: for proVision 2.55 HF (3425)

3414: for proVision 4.55 HF (3428)

3415: for proVision 6.55 HF (3431)



3416-18
Soft Screen

For use with „proVision“ soft lights.
Frosted surface. 1 piece.

3416: for proVision 2.55 HF (3425)

3417: for proVision 4.55 HF (3428)

3418: for proVision 6.55 HF (3431)



3439
Diffusion Foil

For use with „proVision“ soft lights.
Can be cut to required size.
Dimensions: approx. 60 x 760 cm (2 x 25 ft.)





93325 „videolight 4“ Safety Lighting Unit

Technical data:

Halogen lamps: 2 x 1000 W, 3400 K
Fuses: 2 x F 6.3 A
Cord: 4 m (13ft. 1 in.)
Weight: approx. 1500 g
(3 lbs. 5 oz.)

Dimensions (handle
folded down): approx. 145 x 155
x 190 mm
(WxHxD): (5.7 x 6.1 x 7.5 in.)

Height with handle: approx. 270 mm
(10.6 in.)

Halogen lighting unit for photo, filming and video shooting. Extremely quiet blower cooling for unlimited operation in every position. Four large light flaps for direct-aim lighting. Front attachment with diffuser screen of heat-resistant safety glass for extra-soft lighting.

The upper part can be tilted steplessly for indirect lighting. The handle can be tilted through 180° and when mounted on a tripod assumes the function of a tilting head. For economical storing, the handle folds snugly onto the housing. Two stand threads 1/4". The lamps can be switched on separately and have their own fuses. Additional switch for modelling light (2 x 500 W). Supplied complete with camera bracket and lamps.



93304 „videolight 6“ Safety Lighting Unit

Technical data:

Halogen lamp: 1000 W, 3400 K
Fuse: F 6.3 A
Cord: 4 m (13 ft. 1 in.)
Weight: approx. 1300 g
(2 lbs. 14 oz.)

Dimensions (handle
folded down): approx. 100 x 140
x 190 mm
(WxHxD): (3.9 x 5.5 x 7.5 in.)

Height with handle: approx. 250 mm
(10 in.)

Halogen lighting unit for photo, filming and video shooting. Extremely quiet blower cooling for unlimited operation in every position. Thermostat for automatic shut-off if overheating. Heat-resistant housing. Front attachment with safety-glass diffuser plate for extra-soft lighting. Four large barn doors for direct-aim lighting.

The upper part can be tilted steplessly for indirect lighting. The handle can be tilted through 180° and when mounted on a tripod assumes the function of a tilting head. The unit can then be tilted upward and downward. For economical storing, the handle folds snugly onto the housing. Two stand threads 1/4". Supplied complete with lamp and camera bracket.

3002 Conversion Filter

Complete safety front attachment with light flaps and conversions filter of safety glass for videolight 6 (93304).

Dimensions (WxHxD):
approx. 105 x 125 x 70 mm
(4.1 x 4.9 x 2.8 in.)

93307
„videolight 8 S“
Safety Lighting Unit

Halogen lighting unit for photo, filming and video shooting. Unlimited continuous operation without extra cooling. Front attachment with diffuser made of safety glass. Four barn doors for direct-aim lighting. Temperature-resistant reflector casing, for indirect lighting tilts upward by 90° with five click-stops. Slot shoe for mounting on camera. Thread 1/4" for mounting on stand. On/off switch.

Technical data:

Halogen lamp: 300 W, 3400 K
Fuse: F 2 A
Cord: 4 m (13 ft. 1 in.)
Weight: approx. 690 g (1 lb. 8 oz.)
Dimensions approx. 87 x 164 x 135 mm
(WxHxD): (3.4 x 6.5 x 5.3 in.)

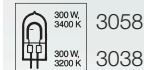

93318
Conversion Filter

Safety front attachment with barn-doors and safety glass conversion filter for videolight 8 S (93307).

Dimensions: approx. 87 x 87 x 75 mm
(3.4 x 3.4 x 3 in.)

93392
„videolight 150“
Safety Lighting Unit

Halogen lighting unit for photo, filming and video shooting. Unlimited continuous operation without extra cooling. Four barn doors to direct the beam. Variable focusing: The angle of light emersion can be adjusted continuously from 40° to 90°. Two mounting possibilities: either flat on the housing - the light tilts by 25° - or raised on pivoting bracket. In this position the light can be tilted upwards and downwards by a total of 100°. 1/4" tripod thread. On/off switch.

Technical data:

Halogen lamp: 150 W, 3400 K
Fuse: F 2 A
Cord: approx. 4 m (13 ft. 1 in.)
Weight: approx. 600 g (1 lb. 5 oz.)
Dimensions approx. 66 x 145 (100) x 125 mm
(WxHxD): mm (2.6 x 5.7 (3.9) x 4.9 in.)

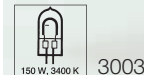

93391
Conversion Filter

Complete attachment with light flaps and conversion filter for „videolight 150“ (93392).



3047
300 W Portable Lighting Kit

Complete light-stand-umbrella combination.

Comprises „videolight 8 S“ 300 W safety lighting unit (93307), light stand (5031), joint with umbrella mount (5041) and white studio umbrella (3080).

In carrying bag with handle and adjustable shoulder strap.



3058



3038



3049
1000 W Portable Lighting Kit

Complete light-stand-umbrella combination.

Comprises „videolight 6“ 1000 W safety lighting unit (93304), light stand (5031), joint with umbrella mount (5041) and white studio umbrella (3080).

In carrying bag with handle and adjustable shoulder strap.



3075



3094

Lamps for Lighting Units

3110, 3124–30 Photoflood

With E 27 screw-in thread.

3110: Energy saving lamp 25 W, 6400 K

3124: Opal Lamp 150 W, 3000 K

3125: Reflector Lamp 500 W, 3200 K

3126: 500 W, 3200 K, without reflector

3128: Reflector Lamp 150 W, 3200 K

3129: Reflector Lamp 500 W, 5000 K,
for use with daylight films

3130: 250 W, 3000 K, without reflector

3454/64 Dulux Fluorescent Lamps

Replacement lamps for soft lights 3425/3428
and 3431.

Power: 55 W

CRI: 90-100

Average service life at steady color
temperature: 8000 hours

Socket: 2 G 11

Length: 533 mm (21 in.)

Tube diameter: 2 x 17.5 mm (0.69 in.)

Please replace fluorescent lamps as a whole
set if requirements for color-correct lighting
are high.

3454: Color temperature 5400 K,
Light color 12, 1 piece

3464: Color temperature 3200 K,
Light color 32, 1 piece

Halogen Lamps

Code no.	Voltage	Power	Color temperature	Socket	Av. service life	Suitable for	Catalogue page
3027	6 V	20 W	3200 K	G 4	100 hrs.	3288	29
3028	12 V	50 W	3200 K	G 6.35	50 hrs.	93310	30
3054	12 V	100 W	3200 K	G 6.35	25 hrs.		
3003	230 V ¹⁾	150 W	3400 K	GX 6.35	20 hrs.	93392	45
3038	230 V ²⁾	300 W	3200 K	GX 6.35	75 hrs.	3152, 3164, 93304, 93307, 93325	34, 35, 38, 44-46
3058	230 V ¹⁾	300 W	3400 K	GX 6.35	15 hrs.		
3051	230 V	650 W	3400 K	GX 6.35	15 hrs.	3152, 3164, 93304, 93325	34, 35, 38, 44, 46
3094	230 V ²⁾	1000 W	3200 K	GX 6.35	75 hrs.		
3075	230 V ¹⁾	1000 W	3400 K	GX 6.35	15 hrs.		

¹⁾ also available in 120 V and 240 V

²⁾ also available in 120 V





3102
Clamp-on Lamp Holder

Gooseneck lamp rod, pivotable and variable adjustable. Shock-resistant plastic clamp with non-slip rubber cleats.

For lamps up to 250 W, E 27.

Clamp span: 40 mm (1.6 in.) max.
Lamp staff: approx. 350 mm
(13.8 in.) long

Cord: 2.9 m (9 1/2 ft.), with
cord switch

Supplied without lamp.



3128



3120
Clamp-on Lamp Holder

Lamp rod pivotable, tiltable, and adjustable in height. Plastic-coated non-slip metal clamp.

For lamps up to 250 W, E 27

Clamp span: 60 mm (2.4 in.)
Lamp rod: approx. 250 mm
(9.8 in.) long

Cord: 1.5 m (4.9 ft.),
with cord switch

Supplied without lamp.



3128

5960
20 W Halogen Light

With flexible arm, length approx. 50 cm (19.7 in.), 14 mm (0.55 in.) diam., standard 16 mm (0.6 in.) pin. Use clamps 5027/28 or 5043 for attaching on boards. 1.8 m (5.9 ft.) power cable with integrated cable switch.

Includes halogen lamp 12 V, 20 W, 3100 K, 60° angle of illumination.

5966/81/87
Halogen Lamp

For 5960 and 5965 Halogen Lights.
12 V, 3100 K.

5981: 20 W, 10° angle of illumination

5987: 20 W, 38° angle of illumination

5966: 20 W, 60° angle of illumination



5965
50 W Halogen Light

With flexible arm, length approx. 50 cm (19.7 in.), 14 mm (0.55 in.) diam., standard 16 mm (0.6 in.) pin. Use clamps 5027/28 or 5043 for attaching on boards. 2.5 m (8.2 ft.) power cable and dimmer with end-position switch-off.

Includes halogen lamp 12 V, 50 W, 3100 K, 60° light angle. 20 W and 35 W halogen lamps can also be used.

5967-68/82-83/88-89
Halogen Lamp

For 5965 halogen light. 12 V, 3100 K.

5982: 35 W, 10° angle of illumination

5988: 35 W, 38° angle of illumination

5967: 35 W, 60° angle of illumination

5983: 50 W, 10° angle of illumination

5989: 50 W, 38° angle of illumination

5968: 50 W, 60° angle of illumination





5952

5945

„macrospot 1500“ Fiber-Optic Lighting System

For pinpointed uniform and powerful lighting for macro and micro photography, for table-top photography and for lighting inaccessible areas. Due to the very low heat development and high light yield, cold light is also widely used in microscopy, medicine, fine engineering etc. The two flexible, jointly detachable, glass-fibres optical light guides with swan's neck sheathing can be moved into almost any position required. Angle of reflection approx. 67°. Two-stage switching for full and reduced lighting power, with constant colour temperature of 3200 Kelvin maintained. Extremely low-noise fan cooling at the back of the light source, so subjects not exposed to heat. Only very slight heating of housing due to special heat-dispersing design. Illuminated on/off switch.

Technical data:

Halogen cold light

mirror lamp: 15 V, 150 W, 3200 K

Cord: approx. 2.50 m (8.2 ft.)

Weight: approx. 4.8 kg (10 lbs. 9 oz.)

Dimensions: approx. 230 x 115 x 205 mm
(9.1 x 4.5 x 8.1 in.) (w/o handle)

Length of optical light guide:
approx. 50 cm (19.7 in.)

5946

Iris Diaphragm

For adjusting the angle of reflection from approx. 38° to 20° minimum and simultaneous dimming by max. five stops. With slot for filter inserts. Can be mounted on light guide. One piece.

5947

Focus Attachment

For reducing the angle of reflection to 38° approx. With slot for filter inserts. Can be mounted on light guide. One piece.

5948-49/5955

Filter Inserts

Filter screen for insertion into iris diaphragm 5946 or focus attachment 5947.

5948: Conversion filter, 3 pieces

5949: Colour filter sets, 3 filter screens each
in red, blue, green, yellow

5955: Polarisation filter, 3 pieces



5946



5947

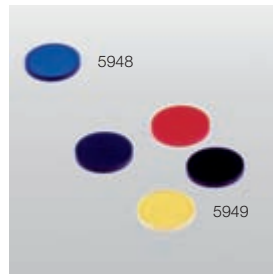

5948

5949

5941 Light Source



5952

Two-stage switching for full and reduced lighting power, with constant colour temperature of 3200 Kelvin maintained. Extremely low-noise fan cooling at the back of the light source. Illuminated on/off switch.



5952 Halogen Cold Light Mirror Lamp

Replacement lamp for lighting system 5945 and light source 5941. 15 V, 150 W, 3200 K, average life approx. 50 hours.

5942-43 Optical Light Guide

For lighting system 5945 and light source 5941. 4 mm thick glass fibre cable with gooseneck sheath. The self-retaining optical light guide can be placed in almost any position. Length per optical light guide: approx. 50 cm (19.7 in.)

5942: 2-arm

5943: 3-arm



5944 Ring Light Attachment

Split ring light for especially homogeneous and shadow-free illumination of subject field. For fastening to camera lenses from 35 to 60 mm (1.4 to 2.4 in.) diameter.

With flexible cord, approx. 75 cm (29.5 in.)



5951 Light Guide with Adapter

Two-arm gooseneck optical conductor with fastening adapter for the Kaiser TopTable product table system and for the rod links on most Kaiser copy lighting units (edge length 16 mm (.6 in.)). Flexible swan's neck cord with plug-in connection for lighting system 5945 and light source 5941, length approx. 90 cm (35.4 in.).



Stands, Umbrellas and other Helpers



The heavier and bigger the lighting unit, the more important the light stand. It should stand firm, even when set to maximum height.

The stand should „suit“ the light, and a cheap solution could soon become

an expensive one, if in case of a „crash“ the light or other things could be damaged.

Most of the lights have a mounting bracket, a tiltable grip or a swivel joint in order to arrange for a specific position on the stand. Additional joints and holding devices provide easy attachment of umbrellas. They are important when light should not hit the subject with its full power or harshness. Very often the amount of light should be reduced to a certain value. Studio and reflector umbrellas are then of great help. The umbrella is mounted at the proper distance in front of the lighting unit. Umbrellas with a black outside coating provide powerful, but diffuse reflection from the inside surface. A white inner coating gives soft, neutral reflections, a silver inside surface leads to more accentuated effects and a gold coated reflector umbrella is the best solution for warm color rendition when shooting portraits or nudes. The translucent white umbrella leads to similar results and can also be used for portraits. As the light is not only reflected but also transmitted, it can also be used for direct lighting.

In the end an umbrella provides for softer, shadowless and more even illumination.

If there is no room for placing stands, clamps and mounting accessories are valuable helpers to attach lights on shelves, doors or to tables.

5031 „Compact“ Light Stand

Light-weight stand made of black anodized light alloy with five-section telescope centre column. Particularly suited for use in portable equipment kits. Solid flat metal legs. With 16 mm standard spigot and 3/8" connecting thread. 1/4" adapter included.

Setting height: approx. 49-200 cm
(19.3 - 78.7 in.)

Length closed: approx. 48 cm (18.9 in.)

Load: max. 1.5 kg (3.3 lbs.)

Weight: approx. 950 g (2 lbs.)

5033 „Standard“ Light Stand

Light-weight stand made of black anodized light alloy with three-section air-cushioned telescope centre column. With 16 mm standard spigot and 3/8" connecting thread. 1/4" adapter included. Folds down flat.

Setting height: approx. 88-237 cm
(34.6 - 93.3 in.)

Length closed: approx. 87 cm (34.3 in.)

Load: max. 5 kg (11 lbs.)

Weight: approx. 1260 g (2.8 lbs.)

5035 „Profi“ Light Stand

Heavy-weight stand made of black anodized light alloy with three-section air-cushioned telescope centre column. With 1/4" / 3/8" reversible thread pin, that can be attached either horizontally or vertically.

Setting height: approx. 105-278 cm
(41.3 - 109.4 in.)

Length closed: approx. 101 cm (39.8 in.)

Load: max. 10 kg (22 lbs.)

Weight: approx. 2200 g (4.9 lbs.)





3195 „Small“ Light Stand

4-section telescopic center column with air cushion. Center column and legs made of aluminium tube.

Reversible thread pin with 1/4" and 3/8" mounting threads, can be positioned horizontally or vertically.

Setting height: approx. 75-230 cm
(29.5 - 90.6 in.)

Length closed: approx. 70 cm (27.6 in.)

Load: max. 3 kg (6.6 lbs.)

Weight: approx. 1650 g (3.6 lbs.)

3196 „Large“ Light Stand

3-section telescopic center column with air cushion. Center column and legs made of aluminium tube.

Reversible thread pin with 1/4" and 3/8" mounting threads, can be positioned horizontally or vertically.

Setting height: approx. 110-290 cm
(43.3 - 114.2 in.)

Length closed: approx. 105 cm (41.3 in.)

Load: max. 10 kg (22 lbs.)

Weight: approx. 2200 g (4.9 lbs.)

3420 Studio Stand

Mobile and extremely stable light stand.
Folding legs with fixable pivoting rollers. Hole
for standard 28 mm (1.1 in.) pin, concealed
standard 16 mm (0.6 in.) pin.

Setting height: approx. 80 to 122 cm
(31.5 to 48 in.)

Load capacity: 25 kg (55 lbs.) on centre

Weight: 8 kg (17.6 lbs.)





5923
Background Cardboard Holder

Holds 110 to 270 cm (3.6 x 8.9 ft.) width background cardboard on rolls.
For mounting on tripods with 3/8" thread.
Width: approx. 85 cm (33.5 in.)

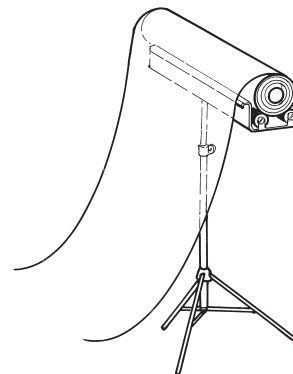
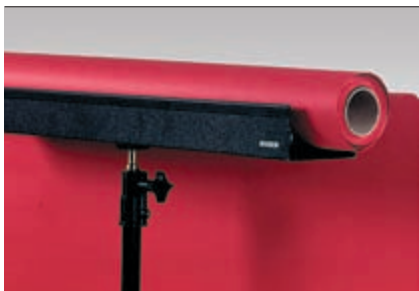

5858-59
Desktop Light Stand

Two-section telescopic center column. With 16 mm standard spigot and 1/4" connection thread.

5858:

Setting height: approx. 22-38 cm (8.7-11 in.)
Length closed: approx. 24.5 cm (9.6 in.)
Load: 3 kg (6.6 lbs.)
Weight: approx. 340 g (12 oz.)

5859:

Setting height: approx. 35-70 cm (13.8-27.6 in.)
Length closed: approx. 39 cm (15.3 in.)
Load: 3 kg (6.6 lbs.)
Weight: approx. 530 g (1 lbs. 3 oz.)

5027
Table Clamp

To mount on tubes and boards. Fits standard 16 mm (0.6 in.) pin. Clamping width: 35 mm (1.4 in.). Weight: approx. 160 g (5.6 oz.).



5028
Table clamp

To mount on tubes and boards. Fits standard 16 mm (0.6 in.) pin. With quick clamping device.

Clamping width: 80 mm (3.1 in.).
Weight: approx. 450 g (15.8 oz.).

Includes movable holding rod with 16 mm standard spigot and 3/8" and 1/4" connecting threads plus 1/4"/3/8" thread adapter.



5023
Universal Clamp

To mount on tubes and boards. Also useful as a holding clamp on tripods and fixtures. With 1/4" and 3/8" connecting threads. Locking lever can be individually positioned.

Clamp span: 42 mm (1.6 in.) max.
Weight: approx. 110 g (3.9 oz.).

Includes spigot 1/4" / 3/8".



5043
Universal Clamp

To mount on tubes of 13-55 mm (0.5-2.2 in.) diameter. Supplied with a wedge. Then can be mounted on approx. 30 mm (1.2 in.) thick boards. Fits standard 16 mm (0.6 in.) pin.

Weight: approx. 450 g (15.8 oz.).





5044
Universal Clamp with
Extension Arm

Universal clamping device for boards up to 30 mm (1.2 in.), also suitable for attachment to tubes of 13 to 55 mm (.5 to 2.2 in.) diameter. Detachable extension arm with interchangeable 1/4" and 3/8" mounting threads.



5054
Camera Clamp

55 cm (21.7 in.) long gooseneck arm for cameras up to 600 g (21 oz.), ball head with 30 mm (1.2 in.) base and 1/4" camera thread. Universal table clamp with clamp range up to 30 mm (1.2 in.) on boards or 55 mm (2.2 in.) on tubes.



5039
Flexible Arm

Flexible holding arm with standard 16 mm (0.6 in.) pin, 1/4" and 3/8" mounting thread, black.

Approx. 55 cm (21.7 in.) long, 18 mm (0.7 in.) diam., load (in horizontal position): approx. 600 g (21.1 oz.).

Includes spigot 1/4" / 3/8".

5041
Joint with Umbrella Mount

Heavy-duty metal joint for attaching lighting units to stands. Upper section can be tilted and locked in any position. With hole (9.2 mm diam.) for reflector umbrella. Reversible 1/4" and 3/8" thread pin in upper section, reversible 1/4" and 3/8" thread sleeve in lower section.

Height: approx. 115 mm (4.5 in.)



5045
Base for Flexible Arm

Base for 5039 Flexible Arm, 5040 Magic Arm, for 5960 and 5965 halogen lights, etc. With 16 mm (0.6 in.) sleeve for standard pin. Variable leg distance up to 48 cm (18.9 in.) max.

Weight: 2.2 kg (4.8 lbs.)



5040
„Magic Arm“ Hinged Bracket

To mount and individually align cameras, lights and accessories. Mounted with reversible thread adapter on tripods and clamps with a 16 mm (0.6 in.) sleeve. Mounting platform with sliding 1/4". Camera screw, 3/8" conversion thread and reflector umbrella mount. Reversible thread adapter with 1/4" and 3/8" internal thread and with ball-and-socket joints at both ends. Both ball-and-socket joints and the middle joint are released and tightened by a central locking disk. Max. load (in horizontal position): 4 kg (8.8 lbs.)



5055-56
„Magic Arm Mini“ Hinged Bracket

To mount and individually align cameras, lights and accessories. With ball-and-socket joints at both ends. Both ball-and-socket joints and the middle joint are released and tightened by a central locking disk. Sturdy metal design. 1/4" camera connection thread. Max. load 2 kg (4.4 lbs.), in horizontal position 1 kg (2.2 lbs.). Includes comprehensive adapter set.

5055: Magic Arm Mini 1
Total length approx. 18 cm (7.1 in.)

5056: Magic Arm Mini 2
Total length approx. 28 cm (11 in.)





3080 Studio Umbrella

With white nylon fabric. Suitable as reflector or for shoot-through lighting. For use with lighting units and flash equipment. Chrome-plated rods, umbrella spoke tips of white plastic.

Umbrella-ø: approx. 90 cm (35.4 in.)
 Height: approx. 58 cm (22.8 in.)
 Rod-ø: approx. 7.8 mm (.3 in.)

3081 Reflector Umbrella

For use with lighting units and flash equipment. Inside white. Chrome or nickel-plated rods.

Umbrella-ø: approx. 80 cm (31.5 in.)
 Height: approx. 55 cm (21.7 in.)
 Rod-ø: approx. 7.8 mm (.3 in.)



3042-43 Reflector Umbrella

For use with lamps and flash equipment. For particularly soft lighting, high reflection. Outside black PVC fabric. Rods chrome or nickel-plated.

Umbrella-ø: approx. 85 cm (33.5 in.)
 Height: approx. 58 cm (22.8 in.)
 Rod-ø: approx. 7.8 mm (.3 in.)

3042: inside silver coated for accentuated illumination

3043: inside gold coated for warmer colour reproduction

1522
Reflector Umbrella

White, waterproof coated nylon fabric. For use as a reflector and for shoot-through lighting with small lamps or flash equipment. Rods chrome or nickel-plated.

Diameter: approx. 37 cm (14.6 in.)
Height: approx. 30 cm (11.8 in.)
Rod-ø: approx. 7.9 mm (.31 in.)



3084
Umbrella Mounting Rod

Allows attachment of a studio/reflector umbrella precisely in the line of the lighting unit.
E.g. for use with 1512 clamp or 5041 holding device.

Length: approx. 380 mm (15 in.),
hole for umbrella: approx. 9.2 mm (.36 in.)



1512
Clamp

For simple attachment of flashguns and lightweight lighting units. Removable accessory shoe on ball joint. Tiltable to all sides in infinite steps, lockable in any position. Additional connecting thread 1/4". With reflector umbrella holder ø 9.2 mm. Clamp is impact-resistant plastic with non-slip rubber studs.

Clamp span: max. 40 mm (1.6 in.)
Height: approx. 90 mm (3.5 in.)





**5029
Clamp Adapter**

For attachment of parts with circular profile (ø 7-18 mm/0.3-0.7 in.), e.g. pen cameras, LED light sources, fiber-optic light guides etc. 1/4" connecting thread.



**5046
Holding Clamp**

Double clamp, 20 mm (0.8 in.) max. open width, to mount filter foils, reflectors, masks and other accessories.



**5048
Reversible Thread Pin**

With 1/4" and 3/8" mounting threads. For use with stands, clamps and other mounting devices with 16 mm standard sleeve. Pin is mounted to the light and is inserted into the 16 mm sleeve of the stand or mounting accessory.

Height approx. 68 mm (2.7 in.)



**6040
Mounting Foot**

With accessory shoe for lighting units, flash guns etc.

Tripod thread 1/4" for attachment on tripods.

Dimensions:
94 x 63 x 11 mm (3.7 x 2.5 x 0.4 in.)



**6401
Assorted Screw and
Thread Adapters**

For mounting lights and other accessories. Contains:

1x shoe-mount threaded bolt, 3/8" with 1/4" extension, height 30 mm (1.2 in.)

1x shoe-mount threaded bolt, M16 x 1 with 1/4" extension, height 30 mm (1.2 in.), 1/4" tripod thread

1x lock nut, 3/8" inside thread, ø 28 mm (1.1 in.), height 10 mm (0.4 in.)

1x lock nut, M16 x 1 inside thread, ø 28 mm (1.1 in.), height 10 mm (0.4 in.)

2 x lock nut, 1/4" inside thread, ø 28 mm (1.1 in.), height 8 mm (0.3 in.)

1x lock nut, 1/4" inside thread, ø 21 mm (0.8 in.), height 18 mm (0.7 in.)



**Stands +
Lighting Units
for Image Capturing**

The View from the Top

When you think about the positions a camera is used in relation to the subject to be photographed, two possibilities come into mind:

First there is the well-known posture with the camera - sometimes mounted to a tripod - in front of our eye aiming at the subject, either from the front, the side, from below or at an angle from above. The three dimensions of the subject are always preserved, the type of picture only depends from the chosen perspective.

Then there is the vertical view from above where usually the third dimension is lost.

But that is not important for this perspective. In fact this arrangement is for capturing subjects photographically, that are two-dimensional anyway or where surface, structure, pattern or array etc. is the point. This extends to the aerial photograph, that - taken from an absolute vertical position - will serve as a basis for the production of maps.

Back to earth, this camera position is often used for „reproductions“. In general a reproduction is understood as a faithful rendition of a copy in a different scale. Even if the reproduction does not stay that „faithful“, the copy has to be captured first in its original form. Devices for reproduction or „copying“ are well known to all of us. Photocopiers and flatbed scanners are such devices. Actually everybody who owns a camera has such a „copying machine“ provided that the lens will make a sharp picture at the necessary distance.

„If you want to do reproductions with an ordinary camera, the use of a -> stand or a copying device is indispensable.“ (Urs Tillmanns, Photo Encyclopedia, Schaffhausen 1991).

And here we are, dealing with the subject.



As „faithful rendition“ is not always necessary any more, we should perhaps not speak of reproductions, but of a special way of „image capturing“, because this has no meaning with respect to the rendition of the „captured“ subject. And this fits today's digital photographic world much better. Much of the „capturing work“ is done by the flatbed scanner, often limited to letter format sizes, but cameras will also find many fields of application here.

The indispensable stand for that purpose, the often equally essential lighting equipment and many more useful helpers can be found on the following pages. Only when copy stage and storage stage – i.e. the plane of the sensor – are absolutely parallel, all angles are exactly the same as the original is and the captured image is in accordance with the original's geometry.

Therefore camera stands for image capturing applications must be stable and precise. They usually have a baseboard to carry the original (sometimes with an integrated lighting system for transparent originals), a column and a camera arm. Various lighting units are available for reflective originals.

The height of the camera arm can be continuously adjusted on the column. In this way the desired frame and reproduction ratio can be set with high precision and consistent parallelism.

Depending on the size and weight of the camera, the size and nature of the original and other requirements there are camera stands in different sizes and lighting units in various configurations. Please read the next pages to get acquainted with the respective product families.



Family Relationships

Combined with a suitable camera, stand and lighting equipment represent a complete problem solution for image capturing tasks. Kaiser has organized these camera stands and lighting units in different system families. We use the term „system“ because all devices can be adapted to various requirements due to their modular construction and additional upgrade components.

Grouping the devices in families, links units and components that fit together and function together. Besides that, it helps to find the best choices for the specific requirements of the job.

Especially when choosing the light it is essential, that it is suitable and adequate. It is suitable when dimensions and stability match with the type of camera stand. That is why you will find the suitable lighting units always within the same system family.



The rePRO system

For professional requirements in conventional and digital image capturing.



The RD system

The professional system for the digital world.



The Copylizer system

A universal image capturing tool with integrated trans-illuminator.

Many factors have to be considered when checking if the lighting equipment is adequate: size, nature and reflection properties of the photographic subject as well as the type of „film“ used in the camera. Especially with conventional chemical film the color temperature of the light should „fit“ the film.

When using digital „film“, that is in digital photography, new requirements can be important depending on the way, sensor elements are arranged (chip or line). Especially with line scanning cameras and cameras or backs using microscanning or multishot mode, there is a demand for high stability of the light. High-frequency lighting systems are the preferred solution.



The R1 system

High flexibility and extraordinary adaptability are the key features and enable even the accomplishment of very special jobs.



The R2 system

A „amateur system“, also suitable for certain professional requirements.



The reprojid

Everything becomes smaller, lighter, more compact.

A Survey to Begin with

In the tables on these pages you will find all essential specifications of stands and lighting units for image capturing. They provide a quick survey and an easy comparison of selected data.

Most notably they comprise some important information for practical application: the maximum covered original width in relation to specific focal lengths of lenses as well as values of illuminance and feasible exposure time settings with the lighting units.

STANDS

Designation	Code no.	Column height (cm/in.)	Baseboard or illumin. area (i.a.) (cm/in.)	Original width ¹ (cm/in.) for focal length of lens ² 50 mm 100 mm		Suitable lighting unit	
RSP rePRO	5612 with 5615 and 5616/5617	150/59.1 66/26.0	80x60/31.5x23.6, i.a. 48x43/18.9x17	88/34.6	44/17.3	5656/5657	rePRO
RSP 2motion	5710	216/85.0	100x80/39.4x31.5	100/39.4	50/19.7	3425/3428/3431 (see page 42)	
RSP Xtra	5711 with 5712 with 5630	216/85.0 49/19.3 32/12.6	- 86x60/33.9x23.6 86x60/33.9x23.6	- 100/39.4 112/44.1	- 50/19.7 56/22.1		
RSD / RSD mot	5602/5603	120/47.2	68x57/26.8x22.4	60/23.6	30/11.8	5565/5589/5590/5588/ 5558/5557/5556/5591/ 5595/5552/5554/5563 ³	RD
Copylizer exe.cutive	5232 5212	100/39.4 100/39.4	i.a. 43x35/17x13.8 i.a. 43x35/17x13.8	53/20.9 53/20.9	27/10.6 27/10.6	5276/5277/5280/5281 5276/5277/5280/5281	Copylizer
Copylizer ini.tial	5211 5205/5206	100/39.4 67/26.4	i.a. 43x35/17x13.8 i.a. 20x18/7.9x7.1	53/20.9 35/13.8	27/10.6 17/6.7	5270 5267	
RSX	5512	120/47.2	60x50/23.6x19.7	66/26.0	33/13.0	5589/5590/5588/ 5558/5557/5556/ 5591/5595/5552/ 5554/5563 ³ /5565	R1
RS 10	5513	100/39.4	60x50/23.6x19.7	53/20.9	27/10.6		
RS 1	5510	100/39.4	45x50/17.7x19.7	53/20.9	27/10.6		
RS 1	5511	100/39.4	45x50/17.7x19.7	53/20.9	27/10.6		
RS 1 microdrive	5507	100/39.4	45x50/17.7x19.7	53/20.9	27/10.6		
RS 2 XA	5411	76/29.9	40x50/15.7x19.7	38/15.0	19/7.5	5464/5465/5450	R2
RS 2 CP	5301	60/23.6	40x42/15.7x16.5	29/11.4	15/5.9	5464/5465	
reprokid	5360/5361	59/23.2	32x38/12.6x15.0	33/13.0	16/6.3	included with 5360	
Vertikal Stand	4405/5503 4406/5503	63/24.8 100/39.4	32x42/12.6x16.5 32x42/12.6x16.5	34/13.4 53/20.9	17/6.7 27/10.6		

¹ at maximum height ² focal length is related to full frame ³ in connection with 5560 holding rods

LIGHTING UNITS

Designation	Code no.	Power ⁷⁾ (Watt)	Color temp. (Kelvin)	Illuminance (Lux) ⁴⁾	Time/ Aperture ⁵⁾	Suitable camera stand	Replacement lamp code	
RB 5056 HF	5656/5657	4 x 55	5400	7900	1/30	5612 with 5615 and 5616/5617	3454	rePRO
RB 5070 DX	5565	2 x 22	5600	4000	1/15	5602, 5603, 5512, 5513, 5510, 5511, 5507	(LED)	RD
RB 4.55 HF RB 4.36 HF RB 2.36 RB 2.18N HF	5280, 5281 5276, 5277 5270 5267	4 x 55 4 x 36 2 x 36 2 x 18	5400 5400 5400 5400	7500 4700 1500 1160	1/30 1/15 1/8 1/4	5232, 5212 5232, 5212 5211 5205, 5206	3454 5567 5567 5458	Copyizer
RB 5055 HF RB 5004 HF RB 5004 RB 5000 DL RB 5003 UV RB 300 RB 104	5589/5590 5558/5588 5557 5556 5591/5595 5552 5554	4 x 55 4 x 36 4 x 36 2 x 36 6 x 18 2 x 300 4 x 25 4 x 75 4 x 150 4 x 150 4 x 250 2 x 150	5400 5400 5400 5400 UV-A, wave length 366 nm 3200 6400 3000 3000 3200 3000 3200	7900 4900 3100 1600 9000 2200 2200 4200 10000 20000 5000	1/30 1/15 1/15 1/8 1/30 1/8 1/8 1/15 1/30 1/60 1/15	5512, 5513, 5510, 5511, 5507	3454 5567 5567 5567 5569 3038 3110 ⁶⁾ 4356 ⁶⁾ 3124 ⁶⁾ 3128 ⁶⁾ 3130 ⁶⁾ 3128 ⁶⁾	R1
RB 218N HF RB 5020 DS RB 2 R2N CP	5464 5465 5450 5304	2 x 18 2 x 14,5 4 x 75 4 x 150 2 x 18	5400 5600 3000 3000 5400	1160 6000 3000 6000 1160	1/4 1/15 1/15 1/15 1/4	5301, 5411 5301, 5411 5411 5411 included (5464)	5458 (LED) 4356 ⁶⁾ 3124 ⁶⁾ 5458	R2
reprokid	5360	2 x 150	3200	14000	1/60	included	3128 ⁶⁾	

³⁾ in connection with 5560 holding rods

⁴⁾ measured with highest possible evenness of illumination in consideration of the adjustability on the lamp arms to the subject surface: tabloid format, R2 system and reprokid: letter format

⁵⁾ approx. exposure time in seconds at f=8

⁶⁾ not included. 3128 is a reflector lamp, 3124, 3130, 4356 are lamps without reflector, 3110 is an energy saving lamp

⁷⁾ power consumption of lamps

Professional in Every Respect



When you need a maximum in stability, solidity and load capacity, the Kaiser rePRO system is the right choice.

This system is not only at home in photo and video studios, but also in technology, forensics and science, education, research and media production. Because of its extremely high level of stability the rePRO

system is especially suitable to capture large format reflective or transparent originals.

This modular-designed stand is available in several versions: with a table

with fixed working height, with a motorized height-adjustable table and without a table.

According to the job, the table with fixed working height can be equipped with a large base plate or with a transilluminator for translucent originals.

Height adjustment of camera level is motorized and works individually along the entire column via remote control. The camera platform can travel up and down at two speeds, regardless of the supported load.

The version with height-adjustable table has a motorized table and a motorized camera carrier that can be moved along the complete height of the column. This offers enormous flexibility with respect to shooting distance and possible working positions. The version without a table provides for a different sort of flexibility, because it can be combined with various existing working planes.

For precise positioning of the optical axis of the camera, the camera carrier can be shifted horizontally and, in addition, can be tilted by ± 90 degrees.

The column, made of a multi-section special extrusion, is mounted to a firmly attached die-cast base and is extremely sturdy and vibration-resistant.

These professional work stations - equipped with a suitable camera system of your choice - offer optimum conditions for sophisticated image capturing tasks.

5612 Column

Made of special aluminum tube, black anodized, with printed cm and inch scales. Height adjustment motorized, with two speeds. Cable remote control. Constant adjustment speed, independent of load. Any height position is exactly held via self-limiting worm-gear. Automatic end switch by photo sensors. Camera platform horizontally adjustable by parallel guides with friction drive, hand cranks for right-hand/left-hand operation, two locking screws. Build-in spirit level. Camera mounting plate 13 x 13 cm (5.1 x 5.1 in.), tiltable by +/- 90°.

Column height: 150 cm (60 in.)
Maximum load: approx. 15 kg (33 lbs.)
Mounting thread: 1/4" / 3/8" exchangeable

5615 Table Frame

With aluminum die-cast base for 5612 column. Demountable steel tube construction. Stacking tray 80 x 50 cm (31 x 20 in.) Height-adjustable feet.

Height without base: approx. 88 x 66 x 78 cm (34.6 x 26 x 30.7 in.), required floor space: 88 x 104 cm (34.6 x 41 in.).

5617 Trans-Illuminator

To be inserted in the 5615 table frame. Illuminated area 48 x 43 cm (18.9 x 16.9 in.), glass cover plate. Total working area 80 x 60 cm (31.5 x 23.6 in.)

Lamps: 4 x 55 W. Continuously dimmable. Built-in fan cooling, no thermal load on originals. Luminance 6700 cd/m², high-frequency operation. Color temperature of lamps 5400 K, CRI = 90-100. Average service life approx. 8000 hours.

5627 Close-up Adapter

Bracket to reduce the minimum camera-to-baseboard distance. Mounts on the camera carrier.

4421 rePRO Adapter

For use of R1 system camera arms.

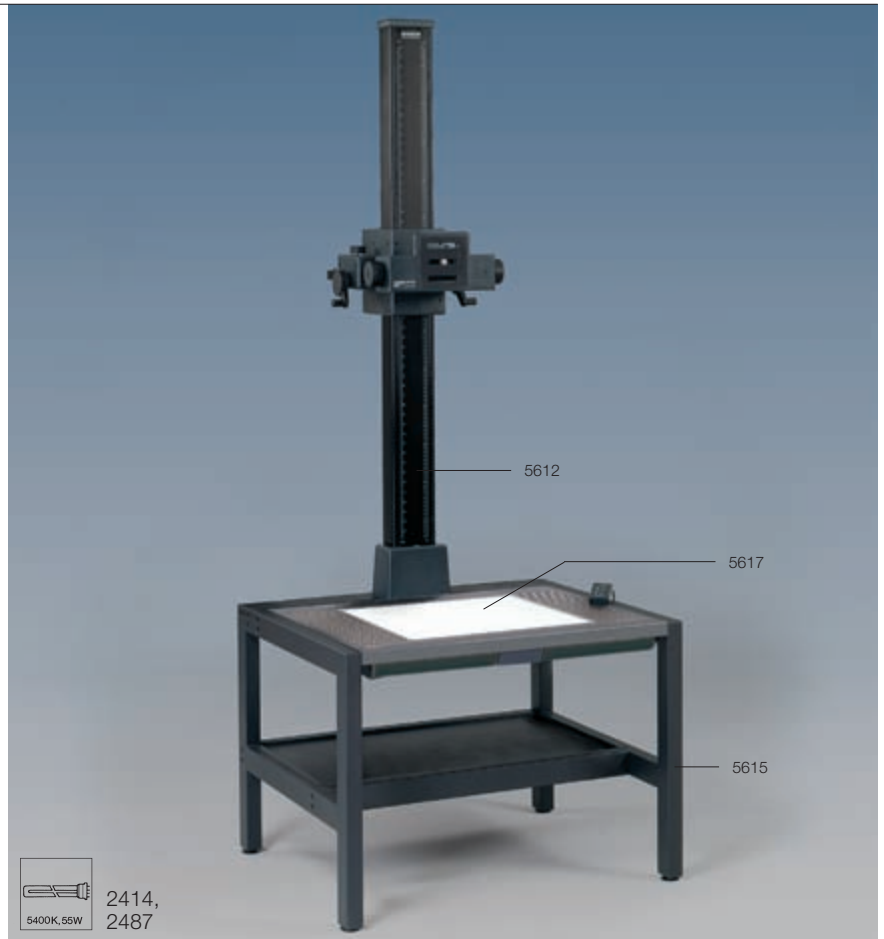

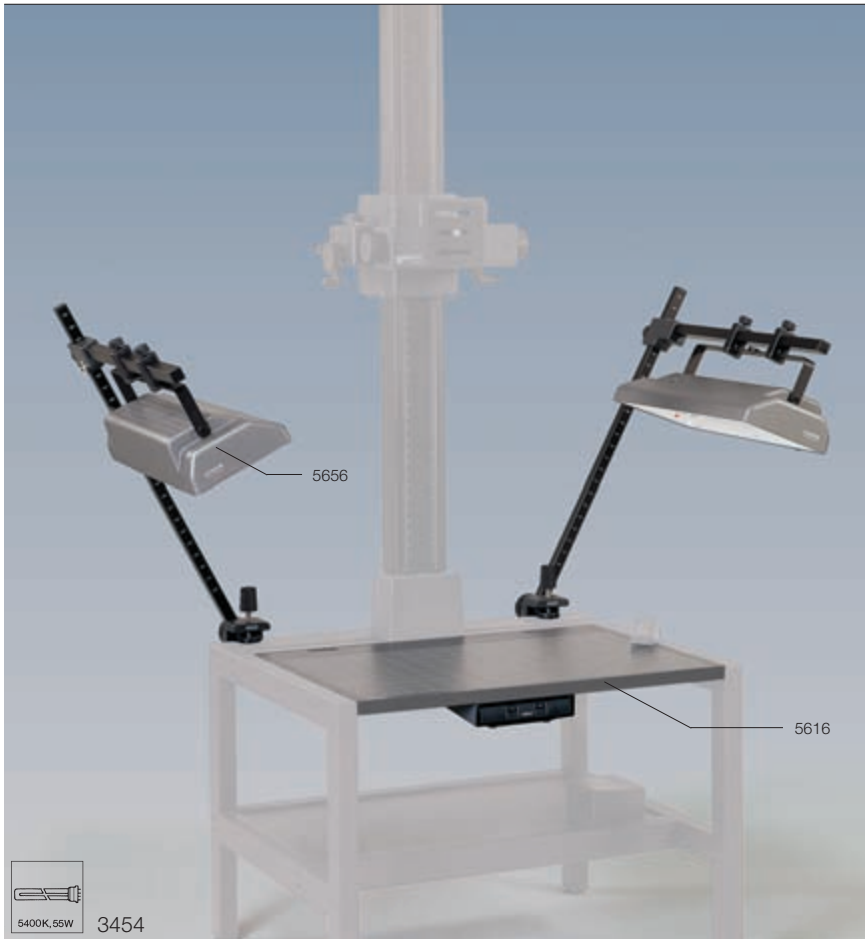

5656-57 RB 5056 HF Lighting Unit

5656: Two light banks with high-gloss inside reflectors. Light emitting area 64 x 21 cm (25.2 x 8.3 in.) each. Each bank is equipped with two 55 watt daylight fluorescent lamps, color temperature 5400 K, CRI = 90-100. All-electronic high-frequency operating system (approx. 40 kHz) for immediate ignition and flicker-free operation, can be used with line scanner, micro scanning and multi-hot digital cameras and backs. Lights can be tilted and shifted. Horizontal lamp arms can be adjusted continuously in height. Vertical lamp arms with height markings, tiltable with detents. Mounted with strong die-cast clamp bases, clamp width 15 to 55 mm (0.6 - 2.1 in.). Separate control box. Lamps can be switched individually. Cord: 2.50 m (8 ft.)

5657: extra: continuously dimmable

5592 Filter Holder

Guide rails for slide-in filters for attachment to 5656/5657. Two pairs.

5593 Diffusion Screens

Fine-structured acrylic glass. Slides in 5592 filter holders. 2 pieces.

5594 Polarizers

Attaches to 5656/5657 with help of 5592 filter holders. 2 pieces.

5616 Base Board

To be inserted in the 5615 Table Frame. Dimensions (WXD): 80 x 60 cm (31.5 x 23.6 in.). High-compressed wooden material, all-side plastic-laminated, with printed grid and cm and inch scales. Includes slide-in carrier for control box of optional lighting unit.

5614 Wall Mount

For wall mounting the 5612 column and the columns of 5710/5711. Lower part with base, spirit level and compartment for power supply. Top section adjustable for vertical column positioning. Screws and dowels included.

Distance wall - column: approx. 35 cm (13.8 in.)

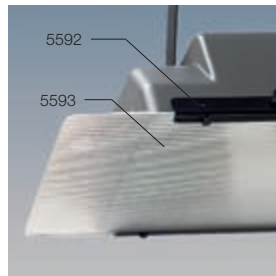

5710 „RSP 2motion“ Camera Stand

Heavy-duty copy stand for analogue and digital image capturing work with two-level motor-driven adjustment. Accepts originals up to 100 x 80 cm (39.4 x 31.5 in.).

Extremely sturdy column, made of a multi-section special extrusion, black anodized, with printed cm and inch scales.

Column foot made of double strutted steel tube. Steel socket for bolting the column. Four levelling feet.

Base board made of 4 mm aluminium with stabilizing substructure.

Camera carrier made of die-cast aluminium, horizontally adjustable by parallel guides with friction drive and hand cranks for right-hand/left-hand operation. Two blocking screws. Camera mounting plate tiltable by +/- 90°. Built-in spirit level.

Camera carrier and base board with individual motorized height adjustment. Two travel speeds, independent of load. Self-limiting worm gear: any height position is exactly held. Automatic end switch by photo sensors. Anti-collision device. Cable remote control.

Specifications:

Total height: 227 cm (89.4 in.)

Maximum working span: 160 cm (63 in.)

Column cross section: 120 x 80 mm
(4.7 x 3.1 in.)

Maximum load

on camera carrier: 10 kg (22 lbs.)

on base board: 15 kg (33 lbs.)

Base board: 100 x 80 cm
(39.4 x 31.5 in.)

Camera platform: 13 x 13 cm
(5.1 x 5.1 in.)

Connecting thread: 1/4" / 3/8"
(interchangeable)

Required floor space: 100 x 126 cm
(WxD) (39.4 x 49.6 in.)

5713 Sheet Steel Plate

Fits on top of the RSP 2motion stand base board. For holding originals with magnetic holders (not included).

Dimensions: 1000 x 0.75 x 800 mm
(39.4 x 0.03 x 31.5 in.)





5711 „RSP Xtra“ Camera Stand

Heavy-duty copy stand for analogue and digital image capturing work with motor-driven height adjustment. Extremely sturdy column, made of a multi-section special extrusion, black anodized, with printed cm and inch scales. Column foot made of double strutted steel tube. Steel socket for bolting the column. Four levelling feet.

Camera carrier made of die-cast aluminium, horizontally adjustable by parallel guides with friction drive and hand cranks for right-hand/left-hand operation. Two blocking screws. Camera mounting plate tiltable by +/- 90°. Built-in spirit level. Camera carrier with motorized height adjustment. Two travel speeds, independent of load. Self-limiting worm gear: any height position is exactly held. Automatic end switch by photo sensors. Cable remote control.

Stand is supplied without base board, intended to be used with table 5712, 5630 (see page 106) or custom-made devices.

Total height: 227 cm (89.4 in.)
 Column cross section: 120 x 80 mm (4.7 x 3.1 in.)
 Maximum load: 15 kg (33 lbs.)
 Camera platform: 13 x 13 cm (5.1 x 5.1 in.)
 Connecting thread: 1/4" / 3/8" (interchangeable)
 Required floor space (WxD): 83 x 114 cm
 (32.7 x 44.9 in.)

5712 Table for Copying Works

Wheeled table for "RSP Xtra" Camera Stand. Also suitable as a table for book cradle 5631. Sturdy steel tube construction with four casters (two are lockable) and matt-grey, plastic-laminated base board 86 x 60 x 3.2 cm (33.9 x 23.6 x 1.3 in.).

Dimensions (WxHxD): 922 x 490 x 680 mm
 (36.3 x 19.3 x 26.8 in.)

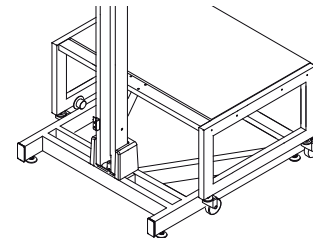

5712

D-Class for Pros

Digital photography has made image capturing much easier. New fields of application have been opened up, there are increased requirements for pictures.

Today's professional users achieve required results with cameras, which are smaller and lighter than those of the analogue era.

The creation of the new RD-System within the range of stands and lighting systems for image capturing is based on these observations. Dimensions and layout had to be adapted to the new situation. This has resulted in a stand with still "table-top" dimensions, but with superior convenience features and stability properties. There is a choice for units with manual or motorized height adjustment. The extensive use of high-precision profiled elements provides for exact adjustment travels and – in addition – has given the unit a new look.

For the first time in this application area Kaiser has designed lighting systems equipped with LED panels with specially selected components for high-quality and stable lighting.

The RD System offers professional equipment for professional users in industry, authorities, research and science – for all image capturing tasks with professional requirements.





5602/03 RSD Copy Stand

Column made of special aluminum multi-section tubing, matt black anodized, with cm and inch scales.

Camera carrier made of aluminum section, can be horizontally adjusted over approx. 16 cm (6.3 in.) with rack-and-pinion parallel guides. Left hand/right hand operation, two blocking screws prevent inadvertent changing of the adjusted position. Camera mounting plate tiltable by $\pm 90^\circ$. Connecting screw horizontally adjustable. Height adjustment with hand crank (5602) or motorized (5603).

Large non-reflecting matt grey base plate with printed grid, cm and inch scales. Feet adjustable in height. Spirit level.

Base plate (WxHxD): 680 x 38 x 570 mm
(26.8 x 1.5 x 22.4 in.)

Height of column: 1.20 m (3.9 ft.)

Column cross section: 105 x 74 mm
(4.1 x 2.9 in.)

Loading capacity: 8 kg (17.6 lbs.)

Camera mounting plate: 130 x 78 mm
(5.1 x 3.1 in.)

Reversing mounting thread: 1/4" / 3/8"
changeable

5602 RSD Copy Stand

Hand-cranked, rack-and-pinion height adjustment, additionally counter-balanced by a built-in coil spring. Blocking screw to stop accidental changing of height.

5603 RSD mot Copy Stand

Height adjustment motorized, with two speeds. Cable remote control. Constant adjustment speed, independent of load. Automatic end switch by photo sensors.

Recommended lighting systems for the RD System copy stands are RB 5070 DX and the copy lighting units of the R1 system (from page 87).

5622 RD Column

Same as 5602, but without base board.

5623 RD mot Column

Same as 5603, but without base board.



5565

RB 5070 DX Lighting Unit

LED daylight lighting unit with two light banks for even and soft illumination. Each light equipped with 288 white high-CRI-LEDs. Lights can be dimmed separately or in conjunction. Dimmer has limit stop.

Lights can be tilted and adjusted in height. Vertical lamp arms tiltable with detents. Mounted with strong die-cast clamp bases, clamp width up to 48 mm (1.9 in.).

LED array: 2 x 288
LEDs: High-CRI
Color temperature: 5600 K
Color rendition index: CRI > 85
LED angle of radiation: 60°
Power consumption: 2 x 22 W
Illuminance on subject surface*: 4000 lux

The RB 5070 DX lighting system is suitable for all RD and R1 System copy stands.

* based on uniform illumination of a 24 x 16" flat subject

5508

Base Stand

For converting RD system camera stands from table to free-standing models. Also suitable for R1 system camera stands and Kaiser base boards from 45 x 50 cm to 60 x 80 cm (17.7 x 19.7 in. to 23.6 x 31.5 in.). Height-adjustable feet.

Dimensions (WxHxD): approx. 580 x 510 x 595 mm (22.8 x 20.1 x 23.4 in.).

For picture see page 85.

5624

Wall Mount

For RD / RD mot columns. Lower part with base, spirit level and compartment for power supply. Top section adjustable for vertical column positioning. Includes mounting material.

Distance wall – camera platform approx. 52-68 cm (20.5 x 26.8 in.).



eVisionary: The Copylizer

Everywhere in industry and administration, in medicine, science and research, in the entire area of communication and information technologies, where photos and other originals have to be copied, catalogued, archived, processed or transformed, there is one thing you need apart from the camera system of your own choice: a Kaiser copylizer. It provides reliable camera mounting and suitable lighting

- for photographic and electronic capturing of subjects of any kind, including three-dimensional subjects,
- for electronic documentation using digital or analogue camera systems,
- for capturing documents, logos, symbols, photos and drawings for further processing in DTP systems or for further use in video conferences or online networks,
- for reproducing and documenting X-ray films, large format slides, silhouetted subjects and transparent objects,
- as a video presenter in schools and universities, at training courses and meetings, in advertising, industry, medical imaging and for use by military and public authorities,
- for integration into evaluation systems for quality testing and monitoring in industry labs.

The stands can be used either with or without the respective side lighting units, as there are mounting provisions on all stands.



5211/12/32
**Copylizer eVision exe.cutive/
eVision exe.cutive HF**

Camera stand with integrated transmitted light source. Illumina base with four 13 W daylight fluorescents 5400 K, illuminated area 43 x 35 cm (16.9 x 13.8 in.). Illuminance 3300 cd/m². Mounting fixtures for optional side lighting unit. Height-adjustable feet. Base with spirit level. 70 mm (2.8 in) wide high-stability, vibration-resistant column made of special aluminum tubing, matt black anodized, with cm and inch scales. Hand-crank operated height adjustment of camera arm by friction drive on plastic bearings. Weight compensation by integrated coil spring, RTP camera arm with horizontally adjustable camera platform, camera body positioning device and interchangeable 1/4" and 3/8" threads.

Illumina base (WxD): 63 x 55 cm
(24.8 x 21.7 in.)
Column height: 1 m (40 in.)
Max. load: approx. 4 kg (8.8 lbs.)
Mains cord: 2.5 m (6.5 ft.)

- 5211:** Mains frequency operation.
Not available in 120 volt.
- 5212:** Illumina base with high-frequency operation system (approx. 40 kHz) for flicker-free operation, especially important for use with digital scanning cameras.
- 5232:** Illumina base with high-frequency operation system, dimmable.



2136,
2477

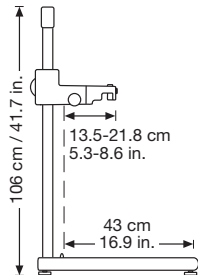



5276/77/80/81
RB 4.36 HF/RB 4.55 HF
Copolyzer Lighting Unit

Lighting unit consisting of two light banks and lamp arms. Lamps can be tilted, shifted and adjusted in height. Vertical arms with height markings, tiltable with detents.

Connects to and is operated via copolyzer illumina base. Lights with high-gloss inside reflectors for high light output plus filter holder and diffusion screen. High-frequency operating system (approx. 40 kHz) for universal use with digital applications.

5276: Lamps: 2 x 36 W each, daylight fluorescent lamp 5400 K, CRI = 90-100, light emitting area approx. 50 x 21 cm (19.7 x 8.3 in.)

5277: same as 5276, but with dimmable lights

5280: Lamps: 2 x 55 W each, daylight fluorescent lamp 5400 K, CRI = 90-100, light emitting area approx. 64 x 21 cm (25.2 x 8.3 in.)

5281: same as 5280, but with dimmable lights

5270
RB 2.36 Copolyzer Lighting Unit

Lighting unit consisting of two light banks and lamp arms. Lamps can be tilted and adjusted in height, with filter holders and diffusion screens. Vertical arms with height markings, tiltable with detents. Connects to and is operated via copolyzer illumina base.

Lamps: 1 x 36 W each, daylight fluorescent lamp 5400 K, CRI = 90-100, light emitting area approx. 50 x 21 cm (19.7 x 8.3 in.)

5256
Clamp Base

For attaching lighting units 5267/5270/5276/5277/5280/5281 to regular boards up to 48 mm (1.9 in.) thickness.
 2 pieces.



5241/42/62 Illumina Base

Can be combined with components of the Kaiser R1 system. Trans-illuminator with four 13 W daylight fluorescent lamps 5400 K, illuminated area approx. 43 x 35 cm (16.9 x 13.8 in.), illuminance approx. 3300 cd/m². Optional side lighting units can be attached, connected and operated. Height-adjustable feet. Base with spirit level for 70 mm (2.8") wide column.

Outside dimensions (WxD):
approx. 63 x 55 cm (24.8 x 21.6 in.)
Mains cord: approx. 2.5 m (6.5 ft.)

5241: Mains frequency operation.
Not available in 120 volts.

5242: High-frequency operation (approx.
40 kHz) for universal use with all
digital applications.

5262: same as 5242, lights dimmable.



2136,
2477

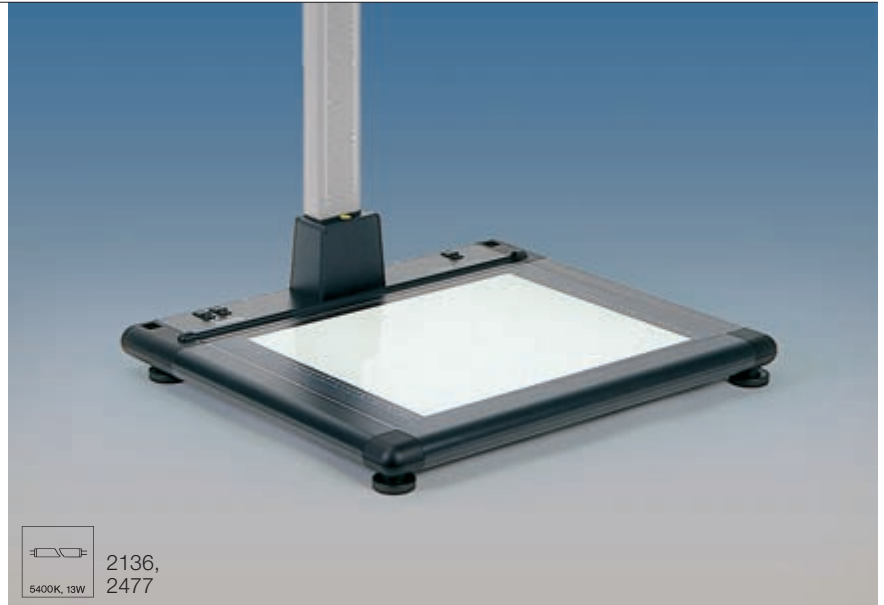

5292 Pressure Plate

For 5211/12/32 Copylizers and 5241/42/62 Illumina Bases.

Made of high-quality crystal glass to press „wavy“ originals. Can be fitted to the hinge of the illumina base and is easily lifted. With adjustable stop guides.

5294 Metal Plate

For 5211/12/32 Copylizers and 5241/42/62 Illumina Bases.

For holding originals with magnetic holders (four included) and as a protective cover of the acrylic glass plate. Can be fitted to the hinge of the illumina base and is easily lifted. With printed grid for positioning and adjustable stop guides.





5205-06
Copylizer eVision ini.tial/
eVision ini.tial HF

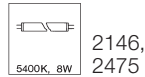
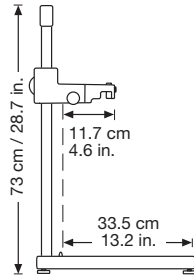

2146,
 2475

Camera stand with integrated trans-illuminator. Illumina base with four 8 W daylight fluorescents 5400 K, illuminated area 20 x 18 cm (7.9 x 7.1 in.). Illuminance 4600 cd/m². Mounting fixtures for optional side lighting unit. Height-adjustable feet. 70 mm (2.8 in.) wide high-stability, vibration-resistant column made of special aluminum tubing, matt black anodized, with cm and inch scales. Hand-crank operated height adjustment of camera arm by rack-and-pinion drive and additional fine drive. Weight compensation by integrated coil spring, RA 101 camera arm with camera body positioning device and interchangeable 1/4" and 3/8" threads. Illumina base (WxD): 32 x 45 cm (12.6 x 17.7 in.)
 Column height: 67 cm (26 in.)
 Max. load: approx. 4 kg (8.8 lbs.)
 Mains cord: 2.5 m (6.5 ft.)

5205: Mains frequency operation.
 Not available in 120 volt.

5206: Illumina base with high-frequency operation system (approx. 40 kHz) for flicker-free operation, especially important for use with digital scanning cameras.



5267
RB 2.18N HF
Copylizer Lighting Unit

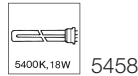

5458

Lighting unit for 5205 and 5206 Copylizer, consisting of two lights and holding arms. Lamps can be tilted and adjusted in height, vertical arms tiltable with detents.

Lamps: 1 x 18 W each, daylight fluorescent lamp 5400 K. High-frequency operation (approx. 40 kHz).

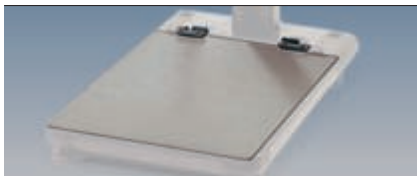

5298
Metal Plate

For 5205 and 5206 Copylizer. For holding originals with magnetic holders (four included) and as a protective cover of the acrylic glass plate. Can be fitted to the hinge of the illumina base and is easily lifted.

The Power of Possibilities

The R1 system is a powerful system. It is universal, sophisticated, flexible, versatile, multi-functional and adaptable.

It is designed for professional users and dedicated photographers and offers high stability, angular precision and quality workmanship.

It is ideal for use with conventional and digital camera systems up to 4 kg (8.8 lbs.) total weight and offers a vast range of components and accessories.

Base boards of various sizes, columns of different height, camera arms with a variety of adjustment options, lighting units with various lamps and reflectors, working at different power levels, with various mounting and adjustment options make it possible to adapt the units to individual requirements.

This system is completely modularized and therefore allows also customized configurations.





5512 RSX Camera Stand

Big non-reflecting matt grey base plate with printed grid, cm and inch scale. Feet adjustable in height. Spirit level in column base. Especially wide and low-vibration column made of matt black anodized aluminium tubing with cm and inch scale. Height adjustment with hand crank and rack with extra weight compensation by integrated coil spring. Blocking screw to stop accidental changing of height. RTX camera arm with adjustable and pivotable camera holder. Camera can be mounted forwards or backwards. Camera platform can be horizontally adjusted by fine mechanism. Interchangeable $\frac{1}{4}$ " / $\frac{3}{8}$ " mounting thread. Including dust hood.

Base plate: approx. 600 x 500 x 32 mm
(23.6 x 19.7 x 1.3 in.)

Height of column: 1.20 m (4 ft.)

Loading capacity: 3.5 kg (7.7 lbs.) max.

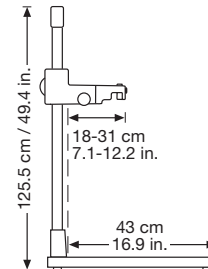

5513 RS 10 Camera Stand

Large non-reflecting, matt grey base board with a printed fine grid and cm/inch scale. Height-adjustable feet. Spirit level integrated into the base. Especially wide, virtually vibration-free column made of matt black anodised aluminium section tube with cm/inch scale. Hand-cranked, rack-and-pinion height adjustment, additionally counter-balanced by a built-in scroll spring. Locking screw prevents inadvertent changing of the adjusted height. RTP camera arm (5524) with precision, parallel-guided horizontal adjustment over approx. 8 cm (3.1 in.). Reversible mounting thread $1/4''/3/8''$. Including dust cover.

Base board (WxHxD): approx. 600 x 32 x 500 mm (23.6 x 1.3 x 19.7 in.)
Column height: approx. 1 m (39 in.)
Maximum load: 4 kg (8.8 lbs.)

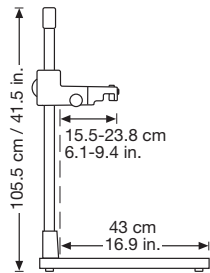

5508 Base Stand

For converting R1 system and RD system camera stands from table to free-standing model. Also suitable for all Kaiser baseboards from 45 x 50 cm to 60 x 80 cm (17.7 x 19.7 in. to 23.6 x 31.5 in.). Height-adjustable feet. Slide-in compartment for control box of optional lighting unit. Dimensions (WxHxD): approx. 580 x 510 x 595 mm (22.8 x 20.1 x 23.4 in.)





5510–11 RS 1 Camera Stand

Non-reflecting matt gray base board with printed fine grid. Feet adjustable in height. Spirit level in column base. Extra-wide and extremely vibration-resistant column of dull black anodized aluminium tubing with cm and inch scales. Hand crank-operated height adjustment by friction drive on plastic bearings. Weight compensation by roll-off spring mechanism.

Base board: approx. 450 x 500 x 28 mm
(17.7 x 19.7 x 1.1 in.)

Column height: approx. 1000 mm (39.4 in.)

5511 RS 1 Camera Stand

With RT 1 copy and titling arm with two camera fastening points. Interchangeable threaded bush $1/4''/3/8''$. Camera carrier pivots and slides horizontally. Maximum load: 3 kg (6.6 lbs.)

5510 RS 1 Camera Stand

With RA 1 camera arm with interchangeable threaded bush $1/4''/3/8''$ and camera adjustment device.

Maximum load: 4 kg (8.8 lbs.)

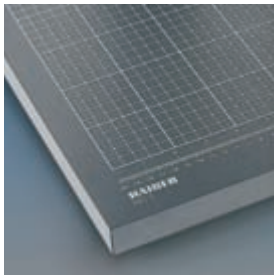
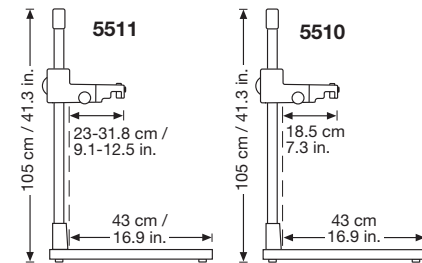

5507 RS 1 „microdrive“ Camera Stand

Same as RS 1 Camera Stand (5510), but with hand-cranked, rack-and-pinion height adjustment, additionally counter-balanced by a built-in scroll spring. Additional fine drive with 1:6 step-down transmission for super-fine adjustment. Locking screw prevents inadvertent changing of the adjusted height.

5589-90
RB 5055 HF Lighting Unit

Cold-light unit with two light banks, each one fitted with two daylight fluorescent lamps, high-gloss inside reflectors and high-frequency operating system. Lights can be tilted and shifted. Horizontal lamp arms can be adjusted continuously in height. Vertical lamp arms with height markings, tiltable with detents. Mounted with strong die-cast clamp bases, clamp width up to 48 mm (1.9 in.). Separate control box.

Lamps: 4 x 55 watt
Color temperature: 5400 K
Color rendition index: CRI = 90-100 (1A)
Light emitting area: 64 x 21 cm
(25.2 x 8.3 in.)

5589: continuously dimmable down to 10%
5590: not dimmable



3454



5591/95
RB 5003 UV / RB 5003 UV-HF
Lighting Unit

UV lighting unit with two light banks, each one fitted with three UV-A fluorescent lamps for applications in UV and fluorescence photography. Lights can be tilted and shifted. Horizontal lamp arms can be adjusted continuously in height. Vertical lamp arms with height markings, tiltable with detents. Mounted with strong die-cast clamp bases, clamp width up to 48 mm (1.9 in.). Separate control box.

Lamps: 6 x 18 watt UV-A
Wave length: 366 nm
Light emitting area: 64 x 21 cm
(25.2 x 8.3 in.)

5591: Mains frequency operation
5595: High-frequency operation
(approx. 40 kHz)

5569
UV-A Fluorescent Lamp

18 watt, average service life 8000 hours,
G 13 socket, length 590 mm. 1 piece.



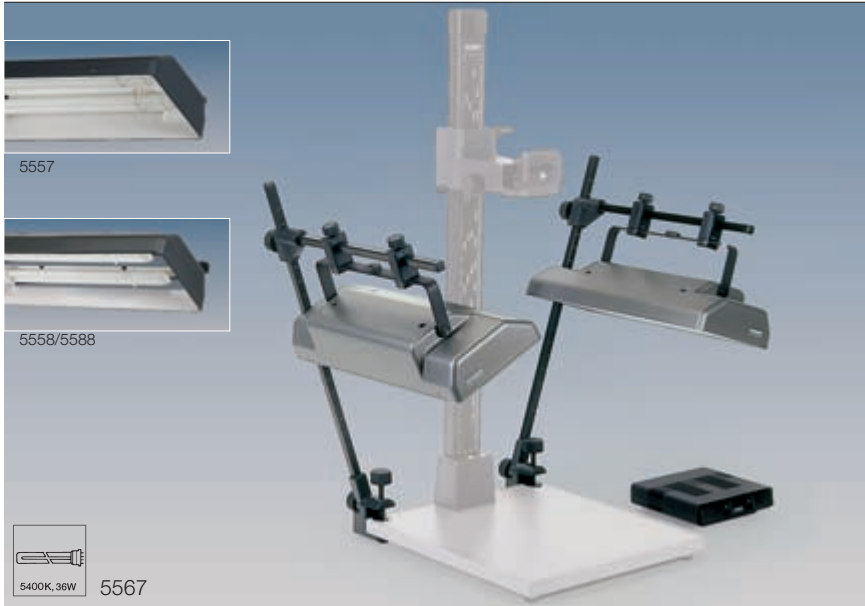

5557-58/5588 RB 5004/RB 5004 HF Lighting Unit

Cold-light unit with two light banks, each one fitted with two daylight fluorescent lamps. Lights can be tilted and shifted. Horizontal lamp arms can be adjusted continuously in height. Vertical lamp arms with height markings, tiltable with detents. Mounted with strong die-cast clamp bases, clamp width up to 48 mm (1.9 in.). Separate control box.

Lamps: 4 x 36 watt
Color temperature: 5400 K
Color rendition index: CRI = 90-100 (1A)
Light emitting area: 50 x 21 cm
(19.7 x 8.3 in.)

5557: Mains frequency operation.
Not available in 120 V.

5558: High-gloss inside reflectors and high-frequency operating system (40 kHz)

5588: High-gloss inside reflectors and high-frequency operating system (40 kHz), continuously dimmable down to 10%.



5556 RB 5000 DL Lighting Unit

Cold-light unit with two light banks, each one fitted with one daylight fluorescent lamp. Lights can be tilted. Horizontal lamp arms can be adjusted continuously in height. Vertical lamp arms with height markings, tiltable with detents. Mounted with strong die-cast clamp bases, clamp width up to 48 mm (1.9 in.).

Lamps: 2 x 36 watt
Color temperature: 5400 K
Color rendition index: CRI = 90-100 (1A)
Light emitting area: 50 x 21 cm
(19.7 x 8.3 in.)

**5582/92
Filter Holders**

Guiding rails to attach slide-in filters to Kaiser camera stand lighting units. 2 pairs.

5582: For reflector size 50 x 21 cm (19.7 x 8.3 in.) (5556-58/5588)

5592: For reflector size 64 x 21 cm (25.2 x 8.3 in.) (5589-91/5595)

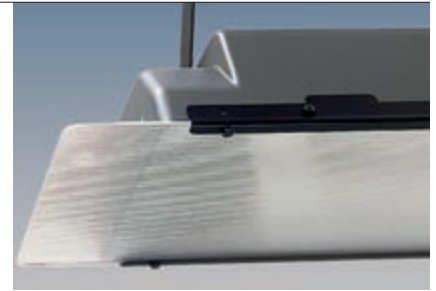

**5583/93
Diffusion Screens**

Fine-structured acrylic glass. Mounts to camera stand lighting units in connection with 5582/92 Filter Holders. 2 pieces.

5583: For reflector size 50 x 21 cm (19.7 x 8.3 in.) (5556-58/5588)

5593: For reflector size 64 x 21 cm (25.2 x 8.3 in.) (5589-91/5595)

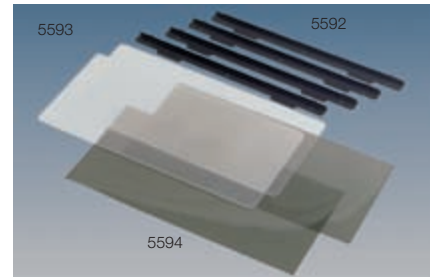

**5594
Polarizers**

Mounts to lighting units 5556-58, 5588-91, 5595 in connection with 5582/92 Filter Holders. 2 pieces.

Dimensions: 64 x 21 cm (25.2 x 8.3 in.), can be trimmed to 50 x 21 cm (19.7 x 8.3 in.)

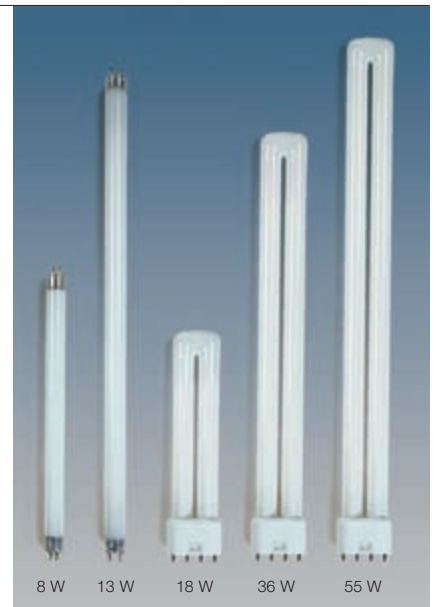

Fluorescent Lamps

Replacement lamps for rePRO, Copylizer, R1 and R2 system. Daylight fluorescent tubes. Color temperature 5400 K, light color 12, color rendition index CRI = 90-100. Average service life: approx. 8000 hours with constant color temperature. For critical requirements on color-correct reproduction replace fluorescents replace in sets.

	Code	Power	Socket	Length (w/o pins) mm/in.	Tube-ø (mm)	Qty. (pieces)	fits
Tube shape	2146	8 W	G 5	288 mm	16	1	5205-06
	2475	8 W	G 5	288 mm	16	4	5205-06
	2136	13 W	G 5	517 mm	16	1	5211/12/32/41/42/62
	2477	13 W	G 5	517 mm	16	4	5211/12/32/41/42/62
Dulux	5458	18 W	2 G 11	217 mm	2 x 17.5	1	5267, 5464, 5304
	5567	36 W	2 G 11	411 mm	2 x 17.5	1	5270, 5276-77, 5556-58, 5588
	2414	55 W	2 G 11	533 mm	2 x 17.5	1	5617
	2487	55 W	2 G 11	533 mm	2 x 17.5	4	5617
	3454	55 W	2 G 11	533 mm	2 x 17.5	1	5280-81, 5589-90, 5656-57



5552
RB 300 Lighting Unit

With two convection-cooled halogen lights. Lights can be tilted and shifted. Horizontal lamp arms can be adjusted continuously in height. Vertical lamp arms with height markings, tiltable with detents. Mounted with strong die-cast clamp bases, clamp width up to 48 mm (1.9 in.). Lights can be switched separately. Lamps included.

Lamps: 2 x 300 Watt
Color temperature: 3200 Kelvin
Cord: 2 x 4 m (2 x 13.1 in.)

3038/3058
Halogen Lamp

For RB 300 Lighting Unit.

3038: 300 W, 3200 K, 7300 lm, average service life approx. 75 hours, 1 piece.

3058: 300 W, 3400 K, 8500 lm, average service life approx. 15 hours. 1 piece.



5554
RB 104 Lighting Unit

With four reflector lights with E 27 screw-in socket, suitable for photofloods up to 250 watt. Lights can be switched separately. Lights can be tilted and shifted. Horizontal lamp arms can be adjusted continuously in height. Vertical lamp arms with height markings, tiltable with detents. Mounted with strong die-cast clamp bases, clamp width up to 48 mm (1.9 in.) Reflector-diameter: approx. 14 cm (5.5 in.). Cord: 2 x 2 m (2 x 6.5 in.).
Supplied without lamps.

Recommended lamps, 1 piece:

4356: Opal lamp 75 W, 3000 K

3124: Opal lamp 150 W, 3000 K

3130: Photoflood 250 W, 3000 K
(without reflector)

3128: Reflector lamp 150 W, 3200 K

3110: Energy saving lamp 25 W, 6400 K

5563
RB 3 Lamp Fixtures



3128

For use with 5560 Lamp Arms.
Lamps: 2 x 250 W max., E 27
Cord: 2 x 2 m (6.5 ft.) with cord switch
2 pieces, without lamps.



5571
Flash/Light Fixtures

For fastening conventional flashes or lights with accessory foot or 1/4" mounting thread to holding rods with 16 mm (.63 in.) square tube, e.g. the 5560 Lamp Arms.



5560
Lamp Arms

Complete set for two or four lights. The arms are adjustable in height and angle and can be fitted with 5563 Lamp Fixtures and with 5571 Flash/Light Fixtures. Clamp attachment on boards up to 48 mm (1.9 in.).



5549
Extraneous Light Protector

Completely shut tent for light-tight shielding of an image capturing work station. Suitable for Copylizer and R1 system copy stands with mounted copy lights. Black teflon-coated fabric, antistatic and lintfree. Front zipper.

Includes mounting rods (WxD: 85 x 80 cm / 33.5 x 31.5 in.), that are attached to the upper end of the column.

Suitable for 1 m (39.4 in.) and 1.20 m (47.2 in.) columns.



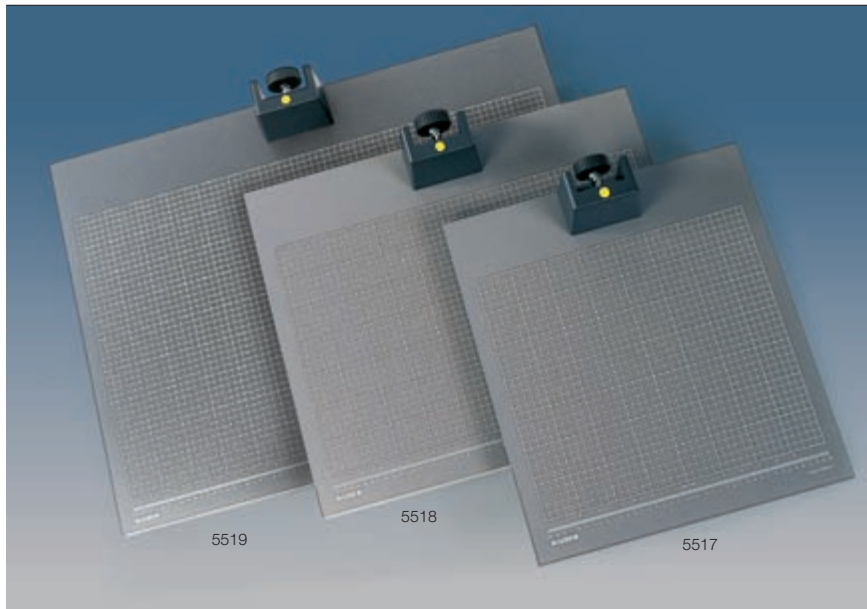

5517-19 Base Board

Matt grey laminated base board with mounted base for attaching column. Printed fine grid with cm and inch scale. Spirit level in base. Individually height-adjustable feet.

Dimensions (WxDxH):

5517: approx. 450 x 500 x 28 mm
(17.7 x 19.7 x 1.1 in.)

5518: approx. 600 x 500 x 32 mm
(23.6 x 19.7 x 1.3 in.)

5519: approx. 800 x 600 x 32 mm
(31.5 x 23.6 x 1.3 in.)

(Dimensions excluding base and feet)

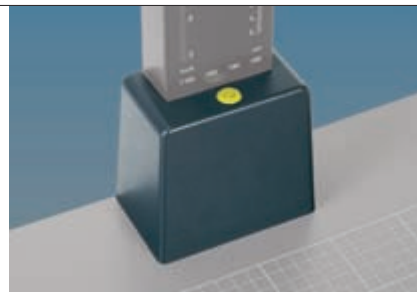

4427 Column Base

For mounting a column with 70 x 35 mm (2.8 x 1.4 in.) cross section to table boards or work plates. Built-in spirit level.

Includes fastening screw for the column and installation material (metal counter plate and four M6x40 screws for boards from 28 to 32 mm (1.1 x 1.3 in.) thickness).

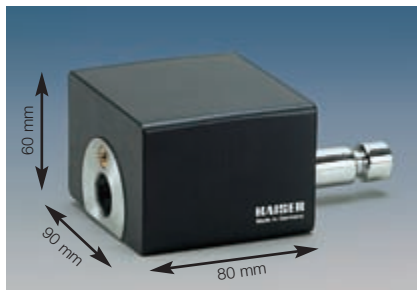

4455 Extension Arm

To extend the camera arm mount. Required for capturing large originals. This increases the distance between the optical axis of the camera lens and the column base by 80 mm (3.2 in.), if the extension arm is attached between the mount and the camera arm.

4473-78/4408-09 Column

Wide and extremely vibration-resistant column of aluminium tubing with dull black anodized surface and cm and inch scales. With mount (4478 with two mounts) and fastening mechanism for camera arms. Height adjustment by hand crank. Cross-sectional dimensions of the column: 70 x 35 mm (2.8 x 1.4 in.)

- 4473:** Height adjusted by friction gear with plastic bearings, without weight compensation, height 1 m (40 in.)
- 4474:** Height adjusted by friction gear with plastic bearings, weight compensated by built-in roller spring, height 1 m (40 in.)
- 4475:** Height adjusted by gear rack with weight compensation by built-in roller spring, additional 1:6 fine drive. Locking screw for fixing height adjustment. Height 1 m (40 in.)
- 4476:** Same as 4475, but without fine drive.
- 4478:** With two mounts for camera arms, each equipped with locking screw for fixing height adjustment. Height adjustment by gear rack, upper mount with weight compensation by built-in roller spring. Height 1 m (40 in.).
- 4408:** Height adjusted by gear rack, weight compensated by built-in roller spring, locking screw for fixing height adjustment. Height 1.2 m (47 in.)
- 4409:** Height adjusted by friction gear with plastic bearings, weight compensated by built-in roller spring, locking screw for fixing height adjustment. Height: 1.5 m (60 in.)



4412 Wall Mount

Sturdy wall mount for all R1 system columns. Wall mounting with 6 screws. Upper part adjustable for absolutely vertical position. Lower part with base and spirit level. Entire height with 1 m column: 1.16 m (3 ft. 10 in.). Distance wall - front edge of mount (without camera arm): approx. 25 cm (9.8 in.) Supplied with screws and dowels.





**5522
RTX Camera Arm**

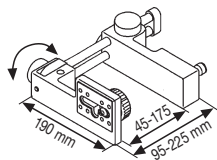

Camera mount with spirit level for fine adjustment. Turns $\pm 180^\circ$ and can be fixed in every position. Camera can be mounted on front or rear. Camera mount horizontally adjustable with fine adjustment.

Interchangeable $1/4''/3/8''$. mounting thread.



**5521
RT 1 Copy and Titrng Arm**

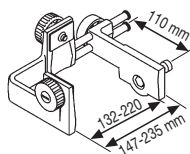

Camera fastening points for horizontal and upright formats, with interchangeable threaded bush $1/4''/3/8''$. and rubber rests.

A parallel guide makes the camera platform longitudinally adjustable, and it can be locked in any position. The entire copy and titling arm is tiltable to allow for reproduction of vertical subjects.



**5524
RTP Camera Arm**

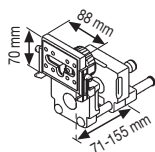

Horizontally adjustable via parallel guides to change the distance to the column. Moves approx. 8 cm (3.1 in.) back and forth. Camera positioning device, adjustable to different camera bodies.

Reversible mounting thread $1/4''/3/8''$.



**5520
RA 1 Camera Arm**

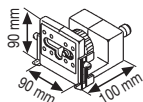

Device for adjusting the camera, can be set to different camera bodies.

Interchangeable $1/4''/3/8''$ mounting thread.

5523
RA 101 Camera Arm

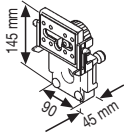

Specially suitable for cameras with large distance between tripod hole and optical axis of lens. Device for adjusting the camera, settable to different camera bodies.

Interchangeable 1/4" / 3/8" mounting thread.



5539
RLR Camera Arm

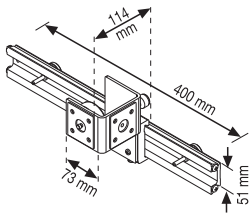

Camera platform can be shifted horizontally to left or right and can be blocked in any position. Adjustable stops for end position of camera. Camera can be mounted for horizontal or vertical format. Especially suitable for use with 5904 Book Holder when copying books page by page.

Camera platform moves approx. 15 cm (6 in.) from center to each side.



5540
2CC Camera Arm

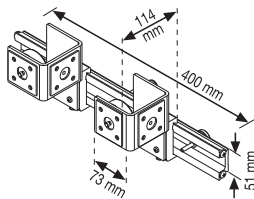

Similar to 5539, but with two camera carriers which can be adjusted separately. For mounting two cameras, e.g. for comparison shots.



5531
Focusing Stage

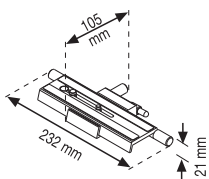

Extremely flat focusing stage with fine drive with spindle. Rapid adjustment with single lever lock. Locking screw. Setting range 120 mm (4.7 in.) with mm scale. Large camera platform with non-slip surface and interchangeable 1/4" / 3/8" mounting thread. 1/4" / 3/8" tripod thread. Made of black anodized aluminum.

Two focusing stages can be combined for crossed stanges.



Heavy Metal

Some working environments and applications require primarily one thing: robustness.

Testing stations in manufacturing, design and quality assurance in industrial production, special climatic conditions or the need to adapt additional equipment sometimes require device properties that exceed the usual standards.

The Vertical Stand is a unit that can cope with these requirements. It is kind of a „Heavy Metal“ version of R1 system stand with a metal base board, that can be completed with a R1 system camera arm (see page 94 - 95).



4405-06
Column for Vertical Stand

Wide and extremely vibration-resistant column of aluminium tubing with dull black anodized surface and cm and inch scales. With mount and fastening mechanism for camera arms. Hand-crank operated height adjustment and gear rack, with weight compensation by built-in roller spring, additional 1:6 fine drive. Locking screw for fixing height adjustment. Cross-sectional dimensions (WxD): approx. 70 x 35 mm (2.8 x 1.4 in.). Includes premounted column base with spirit level.

Suitable camera arms: RA 101 (see page 95) or other R1 system camera arms.

4405: Height: 63 cm (24.8 in.)

4406: Height: 100 cm (39.4 in.)



5503
Metal Base Plate for Vertical Stand

Dark gray finished steel plate with printed fine grid and cut-out section 120 x 120 mm (4.7 x 4.7 in.) for insertion of either a metal cover or a glass insert for transmitted light shooting. Receptacle for accessories with 16 mm (0.6 in.) standard spigot. Height-adjustable feet. Includes metal and glass inserts.

Dimensions (WxD): 320 x 420 mm (12.6 x 16.5 in.), thickness of plate: 8 mm (0.3 in.), weight (without insert): approx. 7.5 kg (16.5 lbs.).

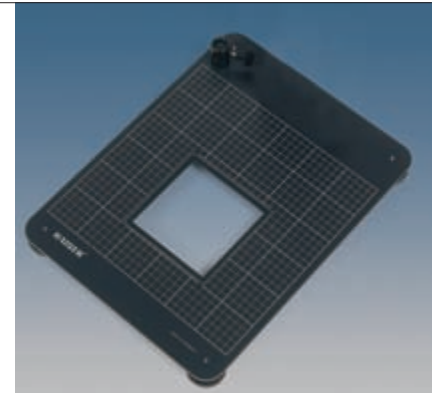

5040
„Magic Arm“ Hinged Bracket

To mount and individually align cameras, lights and accessories. Mounted with reversible thread adapter on tripods and clamps with a 16 mm (0.6 in.) sleeve. Mounting platform with sliding 1/4". Camera screw, 3/8". conversion thread and reflector umbrella mount. Reversible thread adapter with 1/4" and 3/8" internal thread and with ball-and-socket joints at both ends. Both ball-and-socket joints and the middle joint are released and tightened by a central locking disk. Max. load (in horizontal position): 4 kg (8.8 lbs.).



Lightweight Class



Even though cameras are growing smaller and lighter – the stability requirements remain unchanged.

Camera stands and lighting units of the R2 family are „light“ versions of the R1 system. Designed for light-weight cameras, their dimensions and stability are related to the respective needs.

The stands are not only for the majority of digital cameras, compacts and smaller SLRs, but are also suitable for industrial CCD and CMOS cameras.

There is also a range of suitable lighting units: LED panels, high frequency fluorescents, but also basic tungsten lamp lighting.

5411 RS 2 XA Camera Stand

Non-reflective matt grey base board with printed fine grid and cm/inch scale. Matt-black anodised aluminum section tube column with cm/inch scale. Hand-cranked height adjustment by friction drive in plastic bearings. With horizontally adjustable camera arm to change the distance to the column, moves approx. 7 cm (2.7 in.) back and forth. 1/4" mounting thread.

Base board (WxHxD): approx. 400 x 25 x 500 mm (15.7 x 1 x 19.7 in.)

Column height: approx. 76 cm (30 in.)

Maximum load: 1.5 kg (3.3 lbs.)

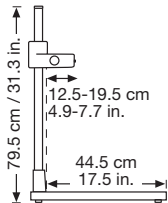

5450 RB 2 Lighting Unit

With four tiltable and adjustable reflectors on mounting arms which are in turn tiltable and adjustable in height. Lights can be switched on separately.

Suitable lamps: 4 x 150 W max.

Clamp attachment for thickness up to 48 mm (1.8 in.).

Cords: 2 x 1.7 m (5 1/2 ft.)

Supplied without lamps.

Suitable lamps, 1 piece:

4356: Opal lamp 75 W, 3000 K, 1100 lm, average service life 100 hours, E27.

3124: Opal lamp 150 W, 3000 K, 2500 lm, average service life 100 hours, E27.

5534 Focusing Stage

For exact camera positioning for close-up, macrophotography and copying.

See page 172 for detailed description.





5465
RB 5020 DS Lighting Unit

LED daylight lighting unit with two light banks for even and soft illumination. Light banks with 192 white high CRI LEDs each. Lights can be dimmed individually or synchronized. Dimmer has OFF position.

Lights are tiltable and adjustable in height. Angle of vertical arms adjustable by lock joint. Mounted with strong die-cast clamp bases. Clamp width up to 48 mm (1.9 in.).

Colour temperature: 5600 Kelvin
Colour rendition index: CRI > 85
Angle of radiation: 60°



5464
RB 218N HF Lighting Unit

Cold light lighting unit with two small light banks with one daylight fluorescent each. High-frequency operating system (approx. 40 kHz). Main leads with cord switches. Lights are tiltable and adjustable in height. Angle of vertical arms adjustable by lock joint. Mounted with strong die-cast clamp bases. Clamping width up to 48 mm (1.9 in.).

Lamps: 2 x 18 watt
Color temperature: 5400 K
CRI = 90-100 (1A)

5458
Replacement Lamp for RB 218N HF

Dulux fluorescent lamp 18 W, 5400 K, Light color 12, CRI = 90-100 (1A), average service life 8000 hrs., socket 2 G 11, length 217 mm (8.5 in.). 1 piece.

5304 R2N CP Image Capturing Set

Portable camera stand with RB 218N HF Lighting Unit (5464).

Non-reflective matt grey base board with printed fine grid and cm/inch scale. Matt-black anodised aluminium section tube column with cm/inch scale. Hand-cranked height adjustment by friction drive in plastic bearings. With horizontally adjustable camera arm to change the distance to the column, moves approx. 7 cm (2.8 in.) back and forth. 1/4" mounting thread. Column folds down on baseboard.

Base board (WxHxD): approx. 400 x 25 x 420 mm (15.7 x 1 x 16.5 in.)

Column height: approx. 60 cm (23.6 in.)
Maximum load: 1.5 kg (3.3 lbs.)

RB 218N HF Lighting Unit with high frequency operating system. Two small light banks, each equipped with a cold light fluorescent lamp, tiltable and adjustable in height. Angle of vertical arms adjustable by lock joint. Mounted with strong die-cast clamp bases. Clamp width 48 mm (1.9 in.).

Lamps: 2 x 18 watt
Color temperature: 5400 K
CRI: 90-100

Comes in padded carrying case 67 x 47 x 23 cm (26.4 x 18.5 x 9.1 in.) with handle and wide shoulder strap.

5301 RS 2 CP Camera Stand

same as 5304, but without lighting unit.

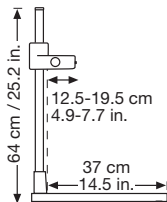

The Story of „Repro the Kid“



Is it really possible to make something that is innately rugged, sturdy and as vibration-resistant as possible still smaller, lighter and more „desktop-suitable“? Individuals with very small budgets and very small cameras have asked for that. And out of that request came the „reprokid“ - a small, light-weight, compact stand for small, light-weight, compact cameras.

This unit is „good enough“ for wherever the requirement is for minimum space and light weight. And really: even the price has moved accordingly.



5360 „reprokid“ Camera Stand

Super-compact camera stand for small, lightweight cameras (digital compacts, CCD cameras, etc.). Non-reflective, matt grey base board. Column with cm/inch scale. Height-adjustable camera arm. 1/4" mounting thread.

Base board (WxHxD): 32 x 1.9 x 38 cm
(12.6 x 0.7 x 15 in.)

Column height: 59 cm (23.2 in.)

Max. load: 1 kg (2.2 lbs.)

Includes lighting unit with two E 27 screw-in mounts for lamps up to 250 Watt (supplied without lamps).

Power cables: 2 x 2.5 m (8 ft. 2 in.), with cord switch.

Suitable lamp:

3128: Reflector lamp 150 W, 3200 K

5361 „reprokid“ Camera Stand

Same as 5360, but without lighting unit.

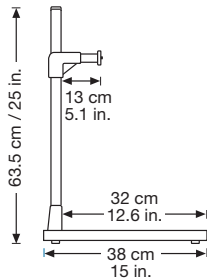

Hold the Post!

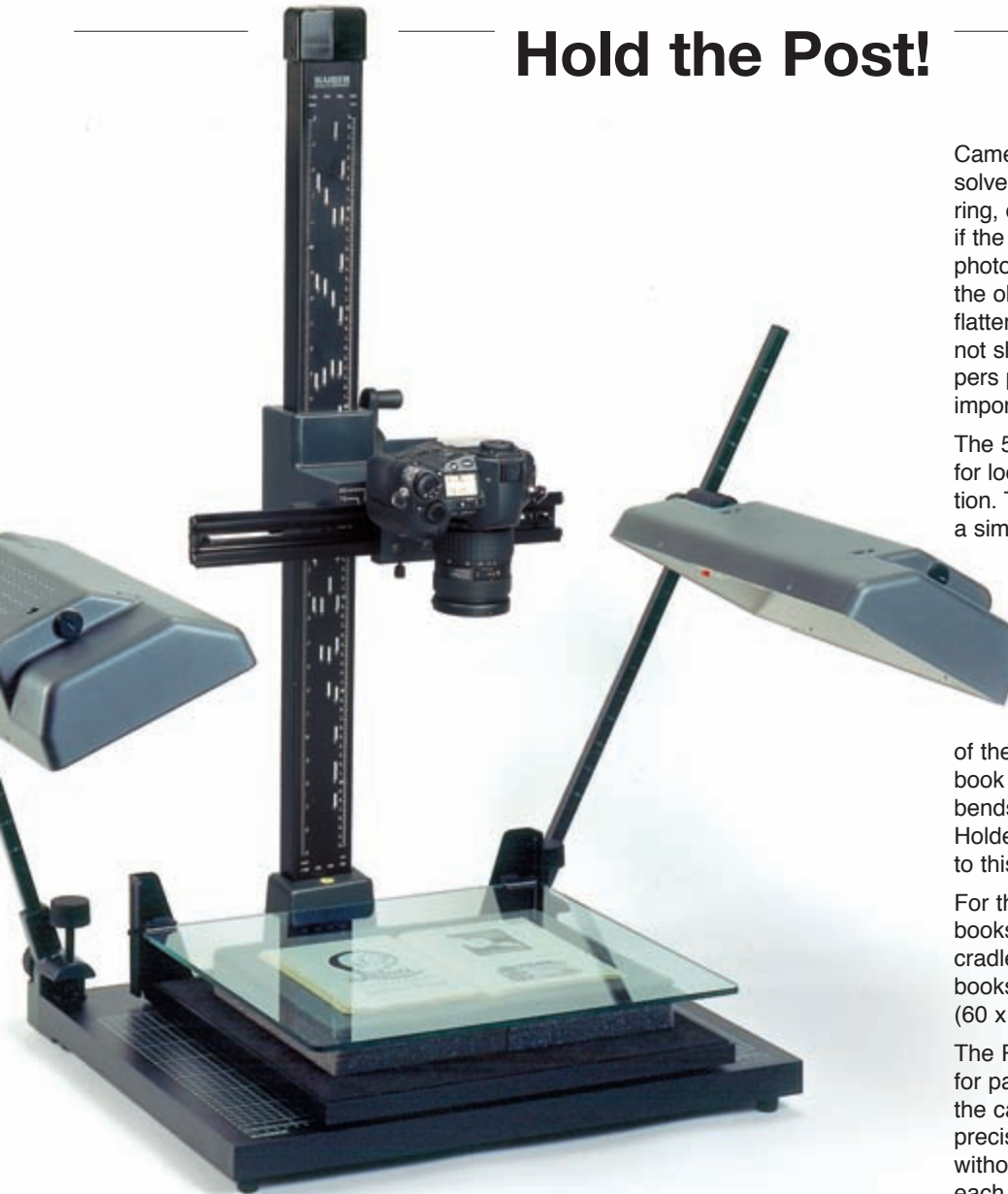

Camera stands and lighting units can solve almost all problems when capturing, digitizing or copying originals. But if the original itself is „reluctant“, if the photo album refuses to stay open or if the old wavy photograph needs to be flattened or the press clipping should not shift, then the little (or bigger) helpers presented here, are of great importance.

The 5901 Copy Plate is a reliable tool for locating originals in a certain position. The 5903 Document Holder does a similar job for smaller originals and allows the possibility to position the original at any desired angle towards the camera.

Especially when copying opened books or albums you have to fight the stubbornness of the inanimate. Normally an open book will not lie flat and each page bends differently. The Kaiser Book Holder is a simple but efficient solution to this problem.

For the professional reproduction from books there is also classical book cradle accepting even large-sized books up to 23.6 x 17.7 in. (60 x 45 cm) open format.

The RLR Camera Arm should be used for page-by-page copying because the camera can always be positioned precisely over the corresponding page without having to move the book for each shot.

5904 Book Holder

43 x 41 cm (16.9 x 16.1 in.) sized, solid base plate with non-slip coating on top non-slip feet underneath. 6 mm (0.2 in.) thick glass plate, foldable and variable in height up to maximum 95 mm (3.7 in.).

Incl. 8 preformed foam elements for height compensation: 2x 20 mm (0.8 in.), 2 x 10 mm (0.4 in.) and 4x 5 mm (0.2 in.), and two black cardboard sheets (each one A4/letter size) so that the print on the back side cannot shine through the paper.

Dimensions (WxHxD): 465 x 130 x 450 mm (18.3 x 5.1 x 17.7 in.)

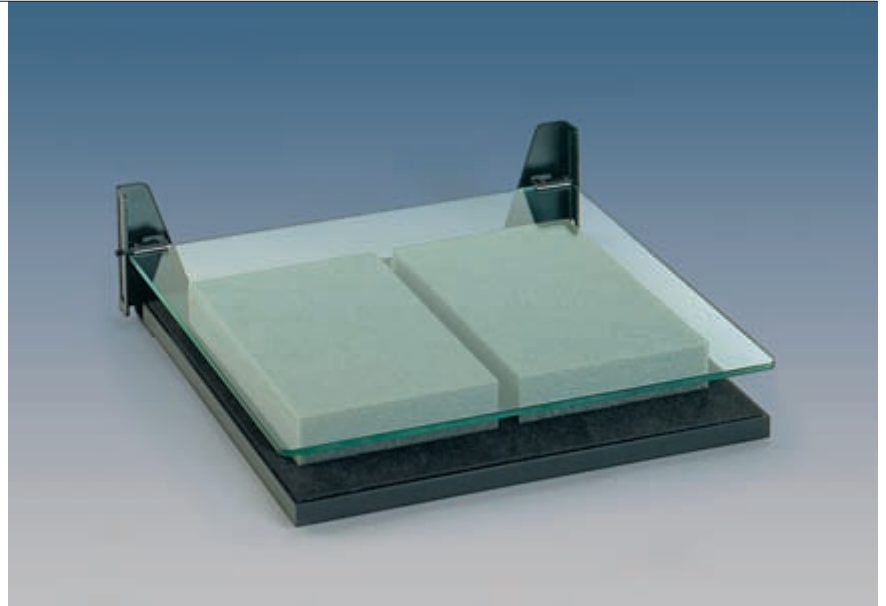

5539 RLR Camera Arm

For Copylizer and R1 system camera stands. For page-by-page copying from opened books or albums without moving the original. Camera platform can be shifted to left or right and locked in any position. Adjustable end-stops. Camera can be mounted in landscape or portrait position.

Moving distance of camera platform: 15 cm (5.9 in.) from center to right or left.

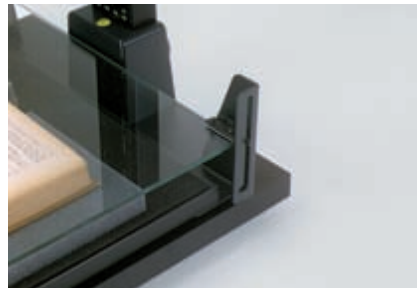



5631 Book Cradle 45/30

Special support for copy work from books with open sizes up to 60 x 45 cm (23.6 x 17.7 in.) and a thickness of 15 cm (5.9 in.). Lockable pressure plate made of 6 mm thick float glass, with antireflection coating on both sides. Easy to unlock by means of release rails on both sides. Glass plate locates in opening position. Two foam-padded platforms – each 30 x 45 cm (11.8 x 17.7 in.) – with adjustable space for spines of different sizes. One-time height adjustment for optimal pressure by means of spindle drive with hand crank. Subsequently automatic pressure control after each turning of a page. Mechanism for quick pressure release and subsequent resetting with previous pressure. Fold-out support bracket to hold large-sized books (up to 90 x 60 cm / 35.4 x 23.6 in. open size) while individual pages are positioned underneath the pressure plate.

Dimensions (WxHxD): 860 x 555 x 650 mm
(33.9 x 21.9 x 25.6 in.)

Weight: approx. 57 kg (125.6 lbs.)



5630 Table

For Book Cradle 5631. Sturdy steel tube construction with four casters (two are lockable) and matt-grey, plastic-laminated base board 86 x 60 x 3.2 cm (33.9 x 23.6 x 1.3 in.). Casters can be exchanged with height-adjustable feet (incl.).

Also suitable as a lower table for copying works together with „RSP Xtra“ Camera Stand.

Dimensions (WxD): 92 x 68 cm (36.2 x 26.8 in.)
Height with casters: 32 cm (12.6 in.)
Height with feet: 25 cm (9.8 in.)

5901 Copy Plate

Metal base plate with non-slip bottom surface. Top surface is matt grey lacquer with 18 % reflection for determining exposure times. Printed grid lines with scales and DIN format markings. Wall mounting is possible.

Size of printed grid area: 460 x 340 mm
(18.1 x 13.4 in.)

Dimensions (WxHxD): 500 x 10 x 380 mm
(19.7 x .4 x 15 in.)

4 copy subject holders made of permanently magnetised section plastic.

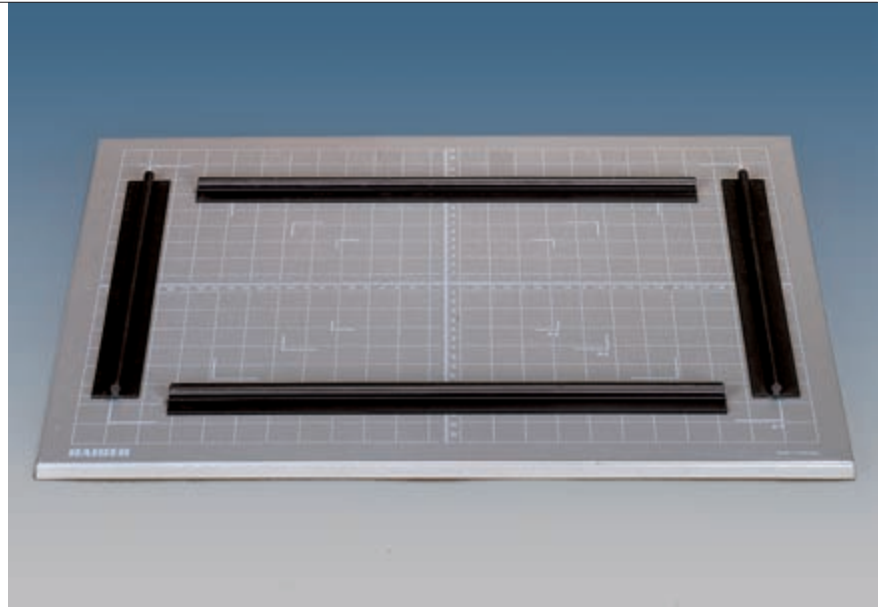

5903 Document Stage

Suitable for documents and originals up to 210 x 148 mm (8.2 x 5.8 in.).

Two adjustable stop rails for accurate positioning of the document. Fixing clamps can be used in various positions.

Platform on ball head can be swivelled and tilted in all directions and pivots to 90°. Height adjustment (up to 40 mm/1.5 in.) with blocking screw. Spirit levels in platform and base. Four individually adjustable feet.

Dimensions (WxHxD): 265 x 173 (213) x 210 mm (10.4 x 6.8 (8.4) x 8.3 in.)





5907-08
Reflection Shield

Avoids reflection of the camera body on reflective originals. Attaches with holding ring in camera filter mount.

5907: For lenses with 62, 58 and 55 mm filter thread

5908: For lenses with 55, 52 and 49 mm filter thread



6378
„Action Level Cross“
Digital Level

Cross indicator with 13 LEDs for simultaneous two-dimensional indication. Additional 7 LED side level indicator. Provides level check for camera in landscape or portrait position.

See page 174 for detailed description.



6383
„Action Level Sound“
Digital Spirit Level

Can be used in portrait and landscape formats. Levelling is indicated by LEDs of different colors and/or varying beep sounds. Brightness, sensitivity and signalling can be adjusted.

See page 174 for detailed description.



6385
Spirit Level

One level each for vertical and horizontal shooting position. With mounting shoe and 1/4" tripod bush.

Dimensions: approx. 20 x 25 x 35 mm
(.8 x 1 x 1.4 in.)



6386
Spirit Level

Circular bubble, self-adhesive. For permanent attachment to cameras, tripods etc. Can also be screwed on.



6387
Duplex Spirit Level

With twin levels and two mounting feet for landscape and portrait position. Transparent housing. Attaches to the camera's accessory shoe.

Dimensions: approx. 18 x 18 x 33 mm
(0.7 x 0.7 x 1.3 in.)

Scanning Cameras



Scanning in Three Dimensions



When you speak about „scanning“ you would normally associate this with capturing a two-dimensional original. The flatbed scanner in the mind’s eye is found today on almost any office desk and in many home offices.

But three-dimensional scanning is nothing extraordinary, it’s plain and simple digital photography using a moving CCD line instead of an array. The only restriction: The subjects must not move and continuous light is a must.

The Scando icoss combines the high-quality results of a flatbed scanner with the versatility of a camera.

The Scando scanning camera is a capable tool for those,

- who need high resolution image data for high-quality printed products
- who need finest detail rendition for analysis and measuring

- who need large enlargements without pixelation for verifying and identification
- who need to scan valuable or fragile originals without contact
- who file high-resolution image data for subsequent use.

Aspect ratio and framing is determined by the choice of lens and the distance from the object. Detail and sharp focus can be controlled in the same way as with an SLR using the reflex viewfinder with split image and micro prism spot.

The complete scanning procedure needs only one pass of the triple CCD line.

Flat large-format originals which do not fit on a flatbed scanner, can be captured in total or in detail using reflective light. In this application the Scando serves as a repro scanner for prints, art works, paintings, maps etc. as well as for reproductions from books.

Translucent originals like large-format transparencies, glass negatives, x-ray films and CTs can be scanned with the Scando mounted on a camera stand and using transmitted light.

Application possibilities for using the Scando as a „scanner“ for capturing three-dimensional still objects are as diverse as the objects themselves. This includes photography for medical, scientific, documentary or measuring purposes, for law enforcement or industrial quality assurance.

5124-29
„Scando icoss X“ Scanning Camera

Can be used as a repro scanner or as a scanning camera for three-dimensional objects, always in conjunction with a PC.

Equipped with one resp. two triple-line CCD sensors the camera provides high resolution image files for prepress, for quantitative and qualitative detail analysis in forensics, in industrial measurement and testing and in research and for future-proof documentation and archiving.

Can only be used for non-moving objects.

Supplied without lens.

**5124-26: Scando icoss X/6, X/6 AF
and X/8**

Equipped with one triple-line CCD sensor.

**5127-29: Scando icoss X/N, X/N AF
and X/S**

Equipped with two triple-line sensors.

See pages 112-113 for specifications.



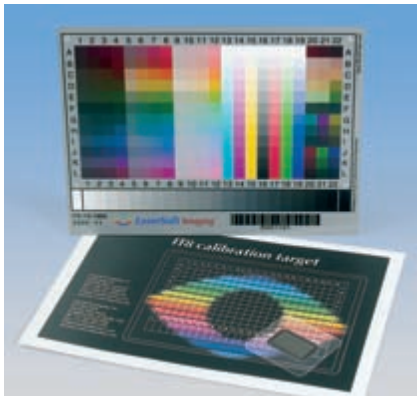

	5124 Scando icoss X/6	5125 Scando icoss X/6 AF	5126 Scando icoss X/8
Type	Digital scanning camera/SLR type		
Viewfinder	Reflex viewfinder with split image and micropism spot for focussing		
Lens mount	Nikon bayonet	Nikon bayonet	Helical focussing mount M 39 x 1
Focussing	manual	autofocus/manual	manual
CCD sensor: Triple line	3 x 9450 pixels	3 x 9450 pixels	3 x 10000 pixels
Scanning area	29 x 38 mm (1.1 x 1.5 in.)	29 x 38 mm (1.1 x 1.5 in.)	40 x 40 mm (1.6 x 1.6 in.)
Pixels	7350 x 9450	7350 x 9450	10000 x 10000
Camera resolution	69 mill. pixels	69 mill. pixels	100 mill. pixels
Maximum file size 8 bit processing 16 bit processing	200 MB 400 MB	200 MB 400 MB	286 MB 572 MB
Color depth	3 x 12 bit (3 x 14 bit)*	3 x 12 bit (3 x 14 bit)*	3 x 12 bit (3 x 14 bit)*
Dynamics (D max)	3.3 (3.9)*	3.3 (3.9)*	3.3 (3.9)*
Scan resolution from letter-size original (optical)	max. 800 dpi	max. 800 dpi	max. 847 dpi
Output size at 300 lpi	62 x 80 cm (24.4 x 31.5 in.)	62 x 80 cm (24.4 x 31.5 in.)	85 x 85 cm (33.5 x 33.5 in.)
Contrast range	11 (13)* f-stops		
Interface	USB 2.0		
Software supplied	SilverFast with Photoshop Plug-In and Twain driver		
Accessories included	Carrying case, USB cable/AC adapter, IT8 targets (reflective, transmitted)		
Operating system	Windows XP, Windows 7		
System requirements	Pentium 4, 3 GHz or better, RAM: 2 GB or more, HD: 200 GB or more	Pentium 4, 3 GHz or better, RAM: 2 GB or more, HD: 200 GB or more	Pentium 4, 3 GHz or better, RAM: 2 GB or more, HD: 200 GB or more

* Multi-Exposure-Function. Makes higher dynamic range possible with transparent originals (X-ray films, slides etc.)

	5127 Scando icoss X/N	5128 Scando icoss X/N AF	5129 Scando icoss X/S
Type	Digital scanning camera/SLR type		
Viewfinder	Reflex viewfinder with split image and microprism spot for focussing		
Lens mount	Nikon bayonet	Nikon bayonet	Helical focussing mount M 39 x 1
Focussing	manual	autofocus/manual	manual
CCD sensor: Two triple line	3 x 9450 pixels	3 x 9450 pixels	3 x 10000 pixels
Scanning area	29 x 38 mm (1.1 x 1.5 in.)	29 x 38 mm (1.1 x 1.5 in.)	40 x 40 mm (1.6 x 1.6 in.)
Pixels	14500 x 19000	14500 x 19000	20000 x 20000
Camera resolution	275 mill. pixels	275 mill. pixels	400 mill. pixels
Maximum file size 24 bit processing 48 bit processing	400 MB 800 MB	400 MB 800 MB	570 MB 1140 MB
Color depth	3 x 12 bit (3 x 14 bit)*	3 x 12 bit (3 x 14 bit)*	3 x 12 bit (3 x 14 bit)*
Dynamics (D max)	3.3 (3.9)*	3.3 (3.9)*	3.3 (3.9)*
Scan resolution from letter-size original (optical)	max. 1600 dpi	max. 1600 dpi	max. 1600 dpi
Output size at 300 lpi	160 x 120 cm (63 x 47.2 in.)	160 x 120 cm (63 x 47.2 in.)	170 x 170 cm (66.9 x 66.9 in.)
Contrast range	11 (13)* f-stops		
Interface	USB 2.0		
Software supplied	SilverFast Archive Suite (Ai IT8-Studio + HDR Studio)		
Accessories included	Carrying case, USB cable/AC adapter, IT8 targets (reflective, transmitted)		
Operating system	Windows XP, Windows 7		
System requirements	Pentium 4, 3 GHz or better, RAM: 4 GB or more, HD: 200 GB or more	Pentium 4, 3 GHz or better, RAM: 4 GB or more, HD: 200 GB or more	Pentium 4, 3 GHz or better, RAM: 4 GB or more, HD: 200 GB or more

* Multi-Exposure-Function. Makes higher dynamic range possible with transparent originals (X-ray films, slides etc.)





5111
Zeiss Planar 1.4/50 mm, ZF.2

Standard lens for scanning cameras „Scando icoss X“ with Nikon bayonet mount (Scando icoss X/6, X/6 AF, X/N, X/N AF).

Optical design: 7 lenses / 6 elements
Lens speed: f/1.4
Focal length: 50 mm
Aperture scale: 1.4-16
Filter thread: 58 mm
Dimensions: length 69-71 mm (2.7-2.8 in.),
ø 66-71 mm (2.6-2.8 in.)



5112
Zeiss Macro-Planar 2.0/50 mm ZF.2

Macro lens for scanning cameras „Scando icoss X“ with Nikon bayonet mount (Scando icoss X/6, X/6 AF, X/N, X/N AF).

Optical design: 8 lenses / 6 elements
Lens speed: f/2.0
Focal length: 50 mm
Aperture scale: 2-22
Filter thread: 67 mm
Dimensions: length 88-91 mm (3.5-3.6 in.),
ø 72-75 mm (2.8-3 in.)



4350
Schneider Lens
Apo-Componon HM 4.0/60 mm

Camera lens for „Scando icoss X/8“ and „Scando icoss X/S“.

Optical design: 6 elements
Aperture scale: 4-22
Diaphragm: preset, click-stop
Filter thread: 43 mm x 0.75
Dimensions: 43.2 mm x ø 46 mm
(1.7 in. x ø 1.8 in.)

Light Boxes

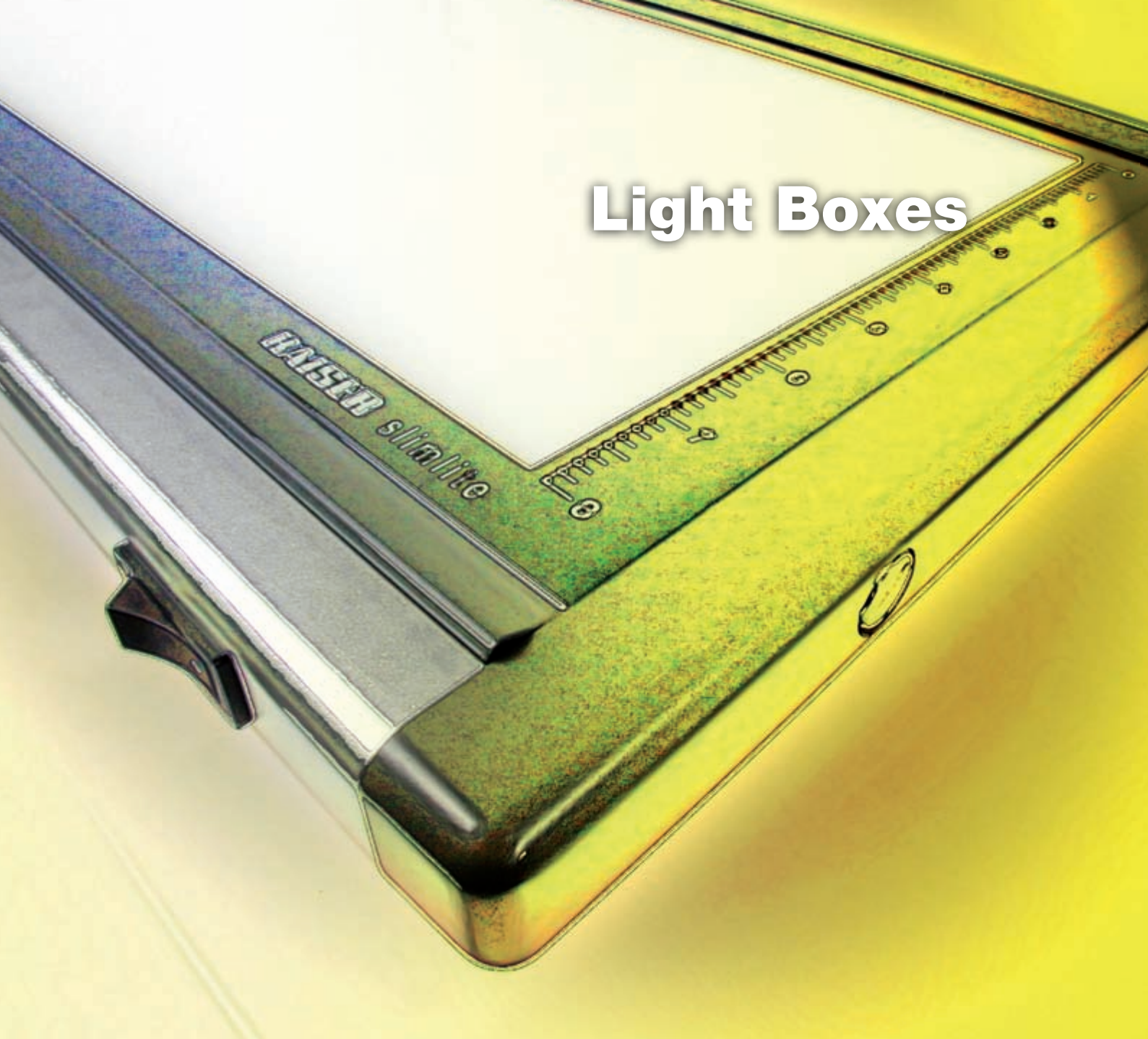

Luminous Surfaces



Light is the elixir of life in photography. This not only applies to the light you need when shooting a picture, but in addition to the lighting conditions when viewing the results.

Light is needed to illuminate and to transilluminate depending on whether the subject is reflective or transparent.

A light box is the appropriate tool to transilluminate a transparent original. It seems at a first glance that this must be the simplest of all light sources:

Take a square box, put some lamps in it, cover it with diffusion - done.

Without doubt, this is a light source, but most likely completely inappropriate for a photographic application.

Because there are stringent requirements for „transmitted light sources“. The most important one is evenness: every spot on the luminous surface should have the same brightness, or - to put it in correct technical terms - luminance of the viewing area should be constant, the inevitable edge drop may not exceed a certain critical value. This is equally important for viewing and inspecting slides as for the photographic reproduction of transparent originals. Selected materials for the lit surface, a well-balanced design of interior reflectors and light conduction techniques are used to meet these requirements.

If you have to inspect color qualities of a transparency or if you want to capture a color original, then it is important that the light box has the correct color properties. Fluorescent lamps with daylight-type spectrum, a well-defined color temperature and a high color rendition index are required. Reflectors and diffusion material have to stay „neutral“, they must not effect the color rendition.

If the transilluminated original is not viewed by the human eye but with a camera, we have to add further requirements. For example there must be a minimum luminance in order to reach practical f-numbers or the luminance must be particularly high to capture specific details.

Above all, there could be additional requirements to the stability of the light. Very often flicker-free lighting is important, and that is achieved by high-frequency operating systems for the fluorescent lamps. For extremely critical applications a residual ripple suppression might be indispensable.

Even fluorescents generate a certain amount of heat, and if you have to use many lamps in a light box to achieve a high illuminance, it might be necessary to take precautions to reduce the thermal load of the originals - an effective cooling system has to be integrated.

But there are still other needs and requirements, for example battery operation on small and portable light boxes. If these - in addition - are extremely flat, they can easily be stowed away in a bag or a briefcase.

The Kaiser light boxes described on the following pages have different features according to the potential requirements. Now you only have to choose the appropriate size and then you have your luminous surface.





2447-49 „slimlite LED“ Light Box

A compact and handy, super-flat daylight light box. Uniform illumination as a result of special light conducting and reflecting technology in conjunction with LEDs. Service life: approx. 10,000 hours. Color temperature approx. 5000 Kelvin. ON/OFF switch. Protective cover included.

2447: Viewing area: approx. 10 x 12.5 cm (4 x 5 in.)
 Dimensions (WxHxD): approx. 16 x 1.4 x 15 cm (6.3 x 0.6 x 5.9 in.)
 Weight: approx. 260 g (9.2 oz.)
 Power consumption: 1.2 W
 Battery powered: 6 x 1.5 V AAA-type
 Mains operation: with mains adapter 2419. Supplied without batteries or mains adapter.

2448: Viewing area: approx. 18 x 13 cm (7 x 5 in.)
 Dimensions (WxHxD): approx. 22 x 2.1 x 19 cm (8.7 x 0.8 x 7.5 in.)
 Weight: approx. 550 g (1 lbs. 3 oz.)
 Power consumption: 2 W
 Battery powered: 6 x 1.5 V AA-type
 Mains operation: with mains adapter 2419. Supplied without batteries or mains adapter.

2449: Viewing area: approx. 30.5 x 20 cm (12 x 8 in.)
 Light box with fold-out feet and clamping strip. Can be wall-mounted.
 Dimensions (WxHxD): approx. 37 x 2.5 x 27.5 cm (14.6 x 1 x 10.8 in.)
 Weight: approx. 1300 g (2 lbs. 14 oz.)
 Power consumption: 6 W
 Mains operation with separate mains adapter (included).



2419 Mains Adapter

To operate the 2447 and 2448 „slimlite LED“ light boxes on the mains.

2450-52 „slimlite LED“ Light Box

Extremely flat daylight light box. Even illumination achieved by using a special method of light conduction and reflection in conjunction with LEDs. Continuously dimmable. Color temperature approx. 5000 Kelvin. On/Off switch. With clamping bar and fold-out bracket. Can be wall-mounted.

2450: Illuminated area: approx. 46 x 20.5 cm
(18.1 x 8.1 in.)
Dimensions (WxHxD): approx. 55 x
3 x 30.5 cm (21.7 x 1.2 x 12 in.)
Power consumption: 8 W
Mains adapter: 24 V, 2 A

2451: Illuminated area: approx. 46 x 30.5 cm
(18.1 x 12 in.)
Dimensions (WxHxD): approx. 55 x
3 x 40.5 cm (21.7 x 1.2 x 15.9 in.)
Power consumption: 12 W
Mains adapter: 24 V, 2 A

2452: Illuminated area: approx. 61 x 35.5 cm
(24 x 14 in.)
Dimensions (WxHxD): approx. 70.5 x
3 x 45.5 cm (27.8 x 1.2 x 17.9 in.)
Power consumption: 15 W
Mains adapter: 24 V, 2 A





2403-06/2423-26/2433-36 „prolite basic 2“ Light Box

5000 Kelvin color temperature. Uses special fluorescent tubes for high color fidelity. Color rendition index CRI = 90-100.

High-quality acrylic-glass plate of exceptionally uniform transmission over the entire visible spectral range. Robust, all-metal housing with non-slip rubber feet and the possibility to mount the light box on a wall. ON/OFF switch.

Sorting attachment for 30 or 70 mounted 35mm slides (only for light boxes with a viewing area of 30 x 21 cm (11.8 x 8.3 in.) and 50 x 30 cm (19.7 x 11.8 in.)).

2 m (6 ft. 7 in.) power supply cable.

2403-06: Basic versions. Mains frequency operation.
2406 is not available in 120 V.

2423-26: as 2403-2406, but with additional integrated high-frequency operating system (operating frequency approx. 40 kHz) for flicker-free start-up and operation.
All sizes are available in 120 V.

2433-36: as 2423-2426, but with additional brightness control for continuously variable dimming down to 10% of maximum light output.

5400K, 8W	2146, 2474
	2136,
5400K, 13W	2476, 2477

Code no.	Illuminated area (cm/inch)	Lamps	Dimensions (cm/inch)	Special features	Replacement lamps (Set of 2 resp. 4 lamps)
2403	30 x 21 cm / 11.8 x 8.3 in.	2 x 8 W	33.5 x 6 x 27.5 / 13.2 x 2.4 x 10.8	HF HF, dimmable	2474
2423	30 x 21 cm / 11.8 x 8.3 in.	2 x 8 W	33.5 x 6 x 27.5 / 13.2 x 2.4 x 10.8		2474
2433	30 x 21 cm / 11.8 x 8.3 in.	2 x 8 W	33.5 x 6 x 27.5 / 13.2 x 2.4 x 10.8		2474
2405	50 x 30 cm / 19.7 x 11.8 in.	2 x 13 W	56 x 6 x 36.5 / 22 x 2.4 x 14.4	HF HF, dimmable	2476
2425	50 x 30 cm / 19.7 x 11.8 in.	2 x 13 W	56 x 6 x 36.5 / 22 x 2.4 x 14.4		2476
2435	50 x 30 cm / 19.7 x 11.8 in.	2 x 13 W	56 x 6 x 36.5 / 22 x 2.4 x 14.4		2476
2406	50 x 60 cm / 19.7 x 23.6 in.	4 x 13 W	56 x 6 x 66.5 / 22 x 2.4 x 26.3	HF HF, dimmable	2477
2426	50 x 60 cm / 19.7 x 23.6 in.	4 x 13 W	56 x 6 x 66.5 / 22 x 2.4 x 26.3		2477
2436	50 x 60 cm / 19.7 x 23.6 in.	4 x 13 W	56 x 6 x 66.5 / 22 x 2.4 x 26.3		2477

2492-93

„prolite scan SC“ Light Box

Professional light box for transparent originals of all types, e.g. slides, negatives, X-rays and microfiches. Color temperature 5000 Kelvin. Four Dulux fluorescent lamps with high color reproduction index CRI = 90-100. Very high illuminance: approx. 50.000 lux. High-frequency operating system (frequency approx. 40 kHz) for flicker-free start-up and operation. Especially suitable as backlight source for use with scanner cameras. No stroboscopic effects, hum and induction interferences. Low-noise, vibration-free fan cooling permits unlimited continuous operation with minimum warming of the viewing surface. Operating hours counter. Working surface with cm and inch scales. Non-slip rubber feet. Can be wall-mounted. On/off switch. Cord 2.5 m (8.2 ft.).

Illuminated area: approx. 48 x 44 cm
(18.9 x 17.3 in.)

Lamps: 4 x 55 W, 5400 K

Dimensions (WxHxD): approx. 63 x 9 x 53.5 cm
(24.8 x 3.5 x 21.1 in.)

2493 with additional brightness control for continuously variable dimming down to 10% of maximum light output.



2414,
2487

2395

DC Voltage Mains Adapter

For residual ripple suppression (< 1%) on devices fitted with high-frequency lighting systems and in conjunction with highly sensitive camera systems. Max. load: 400 W. Not available in 120 V.



2395





2136,
2477

2441 “prolite 5000 HiQ” Light Box

Professional transmitted light source for all kinds of transparent originals. Can also be used for industrial applications (can be attached to Bosch and Item building kit systems).

High quality acrylic glass plate with uniform transmission over the entire visible spectral range. Interior sheet steel reflector with special high-reflection coating for uniform illumination. Equipped with four special fluorescent lamps of high-quality color reproduction properties. Color temperature 5000 Kelvin, CRI = 90-100. Luminous density 3500 cd/m², uniformity of 95 % within a 450 x 300 mm (17.7 x 11.8 in.) area (border masking if required).

High frequency operation system (approx. 40 kHz) for flicker-free start-up and operation. Especially suitable for use with scanning cameras. No stroboscopic effects, hum or induction interference. Sheet steel housing with plastic side shields. Non-slip rubber feet. Can be wall-mounted. On/off switch. Mains lead approx. 2 m (6.6 ft.).

Illuminated area: 500 x 300 mm (19.7 x 11.8 in.)

Lamps: 4 x 13 W, 5400 K

Outside dimensions: 568 x 390 x 67 mm
(22.4 x 15.4 x 2.6 in.)



Print & Slide

After Treatment

Quite often pictures require a certain postprocessing after their “production”. As picture files can be “treated” using suitable software, “seizable” pictures – on paper for example – can also be finished.

One must also not forget the vast number of negatives and slides stored in the archives of ambitious photographers.

For example, pictures and prints have to be trimmed. Trimmers – like those described from page 137 on – provide for clean cutting edges and perfect angles.

Magnifiers are indispensable for precise inspection of pictures and films. Requirements can be extremely different and according to that there is a broad range of magnifiers.

Marking and labelling helps to keep order and control. Special labelling pens for CDRs, RC papers, slide mounts and archiving materials should always be at hand.

You will find these useful little helpers and more on the following pages.



2035/39
„CD[R]pen“ Labelling Pens

For smudge-proof writing on CDRs, slide frames and plastic coated photographic papers. Also suitable for plastic, glass, metal and other smooth surfaces. Quick-drying.

2035: black, 1 piece

2039: set consisting of one each black, red, green and blue

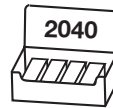

10 pens each
in black, red
green, blue

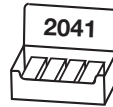

40 pens
in black



6362/65/67
Cotton Gloves

To prevent fingerprints on prints, negatives, optical glass, etc. 100 % Cotton, washable at all temperatures.

6362: one pair, size XL (for large hands)

6365: one pair, size L (standard size)

6367: three pairs, size L (standard size)



6689
Antimagnetic Scissors

Body of fibreglass-reinforced nylon. Cutting blades of specially heat-treated stainless steel, antimagnetic.

Length: approx. 18 cm (7.1 in.)





2372
Pocket Magnifier

Flat slide-out magnifier with LED light.
The LED lights up when loupe slides out.

Magnification: 3x
Lens size: 45 x 38 mm (1.8 x 1.5 in.)
Batteries: 2 x 3 V, CR1130 (included)



2368-69
Hand-Held Magnifier

Stylish loupe with LED illumination.
Ergonomically shaped handle, lens has frosted and rounded off edge.
Batteries: 3 x 1.5 V, LR1130 (included).

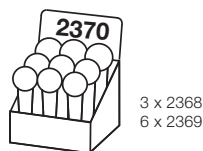

2368: Magnification: 2.4x
Lens diameter: 65 mm (2.6 in.)
Length: 172 mm (6.8 in.)
Weight (incl. batt.): approx. 34 g (1.2 oz.)
2369: Magnification: 2.2x
Lens diameter: 80 mm (3.1 in.)
Length: 189 mm (7.4 in.)
Weight (incl. batt.): approx. 51 g (1.8 oz.)

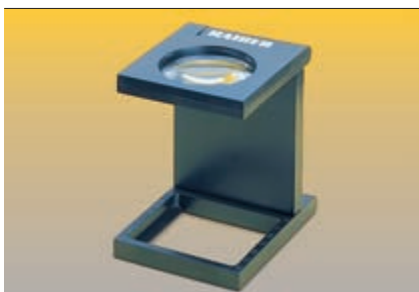

2333
Folding Magnifier

Especially suited for quick checks and measurements of flat objects. Light-weight lens.
Base features 30 mm (1.2 in.) scale calibrated in mm.

Magnification: 5x
Lens diameter: 28 mm (1.1 in.)
Viewing area: 30 x 30 mm (1.2 x 1.2")
Height (in use): approx. 52 mm (2 in.)
Dimensions (folded down): approx. 40 x 50 x 16 mm (1.6 x 2 x .6 in.)



2338
Base Magnifier

Magnifier for allround use with high-grade aspherical lens, hard-coated, made of impact-proof plastic, absolutely scratch-proof. Transparent base. Large viewing field.

Magnification: 4x
Lens diameter: 55 mm (2.2 in.)
Viewing field diam.: 62 mm (2.4 in.)
Height: approx. 60 mm (2.4 in.)

2332/34
Base Magnifier

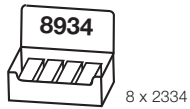

Magnifier for allround use. Transparent base.

2332: With color corrected aspherical lens and eyesight correction.

Magnification: 10x
Lens diameter: 20 mm (0.8 in.)
Height: approx. 40 mm (1.6 in.)

2334:
Magnification: 8x
Lens diameter: 24 mm (0.9 in.)
Height: approx. 45 mm (1.8 in.)



2339
Pocket Microscope

30 x magnification. With focussing mechanism and illumination of viewing field.

Required batteries: 2 x AA (not included)

Dimensions: approx. 140 x 39 x 22 mm
(WxHxD): (5.5 x 1.5 x 0.9 in.)



2336
Replacement Lamp

For pocket microscope 2339.
2.5 V, E 10. Lens form.

2353
Inspection Loupe 10x

Special magnifier with 10x magnification and coated four-element system for surface inspection in forensic and legal applications and in material and printing technology.

Comprises four lighting systems for diffuse reflective, UV (365 nm), oblique and dark field illumination for inspection of structures.

Battery (included): size 23A or similar

Dimensions (WxHxD): 75 x 55 x 48 mm
(3 x 2.2 x 1.9 in.)

Lens diameter: 29 mm (1.1 in.)

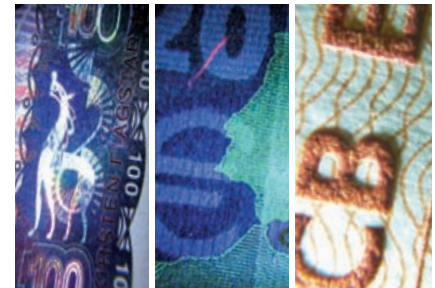

Tools for Manual Workers

Talk about „image processing“ today and you can be pretty sure that this means using the computer to do it. Here you will find digital photographers, viewing their digitized slides on a digital, virtual light box, sorting, „marking“ and archiving them on their computer desktop. Besides the necessary knowledge and the appropriate computer equipment, a strong hand for the mouse and an agile finger for the mouse click is all the „physical effort“ that is required.



But there are still the committed manual workers on the analogue side, who – away from resolution problems and color management discussions – cut and frame their vast stock of slides, view it with „real“ magnifiers, sort and file it or prepare it for digitizing. This type of „image processing“ needs the proper tools also, and that’s what we are talking about here.

2167 „diamount C.A.M./CS“ Slide Cutter and Mounter

Convenient cutting and automatic mounting of 35mm transparencies in C.A.M. and C.A.M./CS mounts. Easy and precise cutting with self-sharpening rotary blade in closed plastic housing. The film is automatically held down while cutting. Sprung friction-wheel transport for uniform advance of the film strip right up to the last frame. Illuminated viewing area with format marks and fixing marks to insert the mounted slides. 2.5x fold-up magnifier, completely detachable. Connection for mains adapter 2009 (optional accessory). Supplied with spare bulb (2107).

Battery operated: 2 x 1.5 V C-type (not included)
Bulb: 2.5 V, 0.3 A, E 10
Dimensions (WxHxD): approx. 17 x 8.3 x 11 cm
(6.7 x 3.3 x 4.3 in.)

2009 Mains Adapter

For mains operation of 2005 Slide Viewer and 2167 Slide Cutter and Mounter.



2156-57 C.A.M./CS Slide Mounts

One-piece glassless snap-down slide mount, 5 x 5 cm (2 x 2 in.), as defined in DIN 108, for automatic mounting with C.A.M./CS slide cutters and mounters. Manual mounting is also possible. Clamping strip to secure and accurately position the transparency. Guide rail for exact position of the transparency during automatic mounting. Mount thickness 1.8 mm (0.07 in.). For CS, LKM and Paximat Compact magazines.

2156: Pack of 100
2157: Pack of 200 + 20





2115
„diacut 1“ Slide Cutter



2109

Slide cutter for film cassettes, cartridges size 126 and 35 mm film. Very easy and accurate cut by self-sharpening rotating round blade in closed plastic housing. Film transport roller for exact size positioning at frame line. Size markings for 18 x 24, 24 x 24, 28 x 28, and 24 x 36 mm. Fingertip recesses for easy removal of cut slide. Illuminated viewing zone. Detachable lift-up 2.5 x magnifying glass. Alignment markings for use with mounted slides.

Lamp: 10 W, E 14, pear-shaped
Cord: 1.8 m (6 ft.)
Dimensions: approx. 125 x 95 x 100 mm
(4.9 x 3.3 x 3.9 in.)



565108
Alfi „dia-clip“ Slide Mount

One-piece glassless snap-down slide mount 5 x 5 cm (2 x 2 in.) for manual mounting. Clamping fixture to secure and accurately position the transparency. Can be re-opened. Mount thickness: 3 mm (0.12 in.)

Two packs of 100.

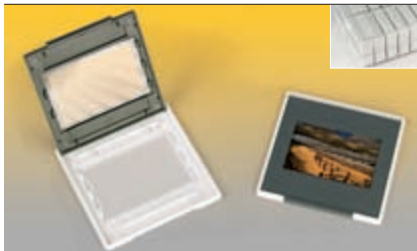

530809
Alfi „dia-fix“ Slide Mount

One-piece snap-down slide mount 5 x 5 cm (2 x 2 in.) with Anti-Newton glass for manual mounting. Clamping fixture to secure and accurately position the transparency. Can be re-opened. Mount thickness: 3 mm (0.12 in.)

Packs of 100 in sturdy plastic box.

2003
„diascop 1“ Slide Viewer



2.5 V, 0.3 A, E10 2107

Slide viewer with 2x magnifying lens for framed slides, 5 x 5 cm (2 x 2 in.) and uncut film strips in protective sleeves. On/off switch.

Battery operation: 2 x 1.5 V C-size (supplied without batteries)
Lamp: 2.5 V, 0.3 amp., E10, spherical
Lens: 76 x 76 mm (3 x 3 in.)
Dimensions (WxHxD): 80 x 160 x 170 mm (3.1 x 6.3 x 6.7 in.)



2005
„diascop 3“ Slide Viewer



2.5 V, 0.3 A, E10 2107

Slide viewer with 3 x magnifying double lens for framed slides, 5 x 5 (2 x 2 in.) and uncut film strips in protective sleeves. Drop chute with collecting tray. On/off switch and connecting socket for mains adapter 2009.

Battery operation: 2 x 1.5 V C-size (supplied without batteries)
Lamp: 2.5 V, 0.3 amp., E10, spherical
Lens: 76 x 76 mm (3 x 3 in.)
Dimensions (WxHxD): 80 x 160 x 170 mm (3.1 x 6.3 x 6.7 in.)



2009
Mains Adapter

For mains operation of 2005 Slide Viewer and 2167 Slide Cutter and Mounter.

2006
„diascop 4“ Slide Viewer



15 W, E14 2008

As 2005, but for connecting to mains.

Lamp: 15 W, E 14, pear-shaped
Cord: approx. 1.8 m (6 ft.)
Dimensions (WxHxD): 80 x 160 x 170 mm (3.1 x 6.3 x 6.7 in.)





2008

2015 „diascop 50 N“ Slide Viewer

Slide viewer with 3x magnifying double lens for 5 x 5 cm (2 x 2 in.) framed slides and uncut film strips, change slider for convenient slide changing without annoying bright intervals, drop chute for up to 40 slides. Top section tiltable for adjusting desired viewing angle, mains connection.

Lamp: 15 W, E 14, pear-shaped
 Lenses: 76 x 76 mm (3 x 3 in.)
 Cord: 1.8 m (6 ft.)
 Dimensions: approx. 150 x 80 x 175 mm
 (WxHxD): (5.9 x 3.1 x 6.9 in.)



2107

2010-11 „diascop mini“ Slide Viewer

Small compact slide viewer for framed slides 5 x 5 cm (2 x 2 in.). With hinged prop.

Required batteries: 2 x 1.5 V AA-size (supplied without batteries)

Lamp: 2.5 V, 0.3 A, E 10, spherical
 Lens: 63 x 53 mm (2.5 x 2.1 in.)
 Dimensions approx. 75 x 60 x 105 mm
 (WxHxD): (3 x 2.4 x 4.1 in.)

2010: with 3-fold magnifying double lens

2011: with 2-fold magnifying lens

2012 Slide Viewer

For framed slides, 5 x 5 cm (2 x 2 in.) and film strips. 2-fold magnification. Lens diameter 18 mm (.7 in.) Dimensions (WxHxD): approx. 55 x 55 x 60 mm (2.2 x 2.2 x 2.4 in.).

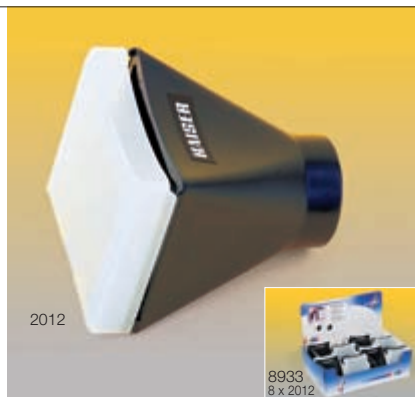

2012



8933
8 x 2012

Negative Filing Sheets

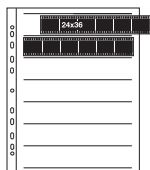

2510/15
2530/35

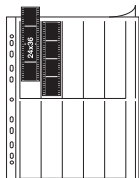

2513

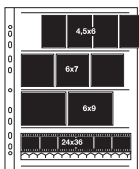

2610
2630

2580/90 Slide Storage Pages

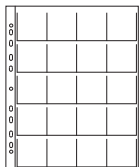

2580
2590

2500/2516 Filing Binder

For the orderly and protected storage and archiving of negative strips. Including cover sheet with index. Margin punched with Euro-holes. Different versions: milky white glassine or clear acetate.

Negative Filing Sheets for 35 mm film

For 42 35mm negatives: 7 strips each 6 negatives. Dimensions: approx. 260 x 310 cm (10.2 x 12.2 in.)

2510: Glassine 100 sheets
2515: Glassine 25 sheets
2530: Acetate 100 sheets
2535: Acetate 25 sheets

For 40 35mm negatives. 10 strips each 4 negatives. Dimensions: approx. 260 x 315 mm (10.2 x 12.4 in.)

2513: Glassine 100 sheets

Negative Filing Sheets for 60 mm film and 35 mm negatives with re-order strip

For 4 negative strips. Dimensions: approx. 260 x 310 mm (10.2 x 12.2 in.)

2610: Glassine 100 sheets
2630: Acetate 100 sheets

For orderly and safe storing and filing of framed slides. Plasticizer-free PP film without chemical effect on the slides. Margin punched with Euro-holes. For twenty 35mm slides in 5 x 5 cm (2 x 2") frames. 10 sheets. Dimensions: approx. 250 x 315 mm (9.8 x 12.4 in.)

2580: Upper and lower side transparent.
2590: Upper side transparent, matte back.

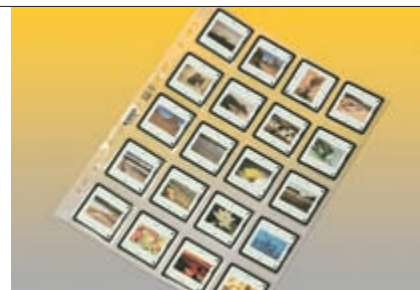
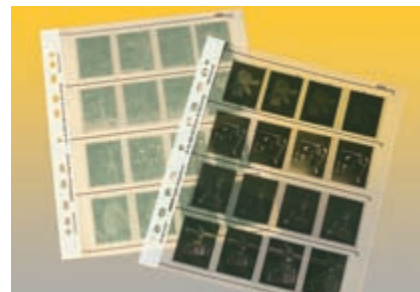
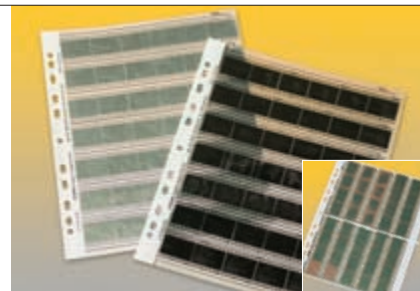

4-ring binder for Kaiser negative filing sheets and transparent slide sleeves. Dimensions approx. 300 x 320 mm (WxH): (11.8 x 12.6 in.) Back: approx. 60 mm (2.4 in.) with slide-in spine label.

2500: Filing binder, empty
2516: Filing binder, complete with 25 negative filing sheets of glassine for 35 mm-film and blank for table of contents.



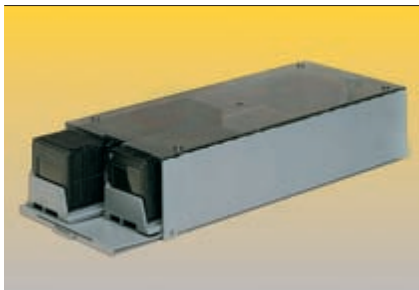

2204
CS Slide Trays

For space-saving, non-spill storage of slides in CS mounts. Suitable for CS-compatible 35mm slide projectors.

Set with 2 stackable boxes, each fitted with 2 CS slide trays for 100 slides each. Box with transparent lid. Trays and stackable box made of impact-resistant plastic.

Dimensions of stackable box (WxHxD):
130 x 65 x 300 mm (5.1 x 2.6 x 11.8 in.)

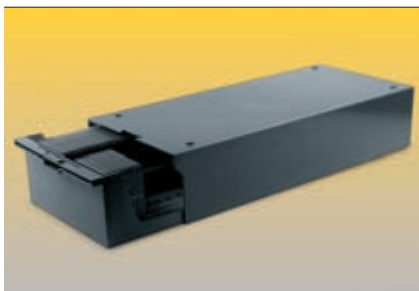

2207
CS Slide Trays

For space-saving, non-spill storage of slides in CS mounts. Suitable for CS-compatible 35mm slide projectors.

Two CS slide trays, each holding 100 slides, in stackable box with drawer. Trays and stackable box made of impact-resistant plastic.

Dimensions of stackable box (WxHxD):
130 x 65 x 300 mm (5.1 x 2.6 x 11.8 in.)



2217
Universal Slide Trays

For the storage of 35 mm slides. Suitable for most 35 mm slide mounts and for almost all 35 mm slide projectors. Universal slide trays and stacking box made of impact-proof plastic. Stacking box with label field on hinged lid.

Set with 3 stackable boxes, each fitted with 2 universal slide trays for 50 slides each.

Dimensions of stacking box (WxHxD):
130 x 65 x 300 mm (5.1 x 2.6 x 11.8 in.)

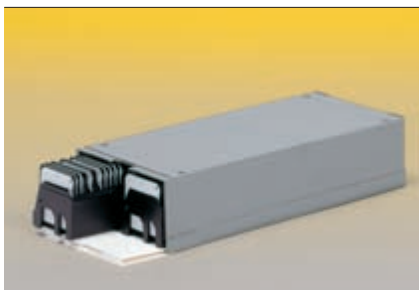

2213
Universal DIN Slide Trays

To store mounted 35mm slides. Suitable for most 35mm slide mounts and almost all 35mm slide projectors. Two slide trays, each holding 50 slides, in a stackable box. Trays and stackable box made of impact-resistant plastic. Trays as defined in German standard DIN 108.

Dimensions of stackable box (WxHxD):
130 x 65 x 300 mm (5.1 x 2.6 x 11.8 in.)

2206
Slide Case

Handy case with four CS slide trays, each holding 100 35mm slides in CS or C.A.M./CS mounts. Case and CS slide trays made of impact-resistant plastic.

Dimensions (WxHxD): approx.
300 x 62 x 350 mm (11.8 x 2.4 x 13.8 in.)



2219
Slide Case

Compact case for storing 35 mm slides. With six universal slide trays each for fifty 35 mm slides. Suitable for most slide mounts and for almost all 35 mm slide projectors.

Dimensions (WxHxD): approx.
290 x 63 x 425 mm (11.4 x 2.5 x 16.7 in.)



2218
Slide Archive

For storing 35 mm slides. With ten universal slide trays each for fifty 35 mm slides. Suitable for most slide mounts and for almost all 35 mm slide projectors.

With carrying handle.

Dimensions (WxHxD): approx.
125 x 350 x 287 mm (4.9 x 13.8 x 11.3 in.)





**2316
Laser Light Pointer**

For beamer presentations, slide, film and overhead projection, screen presentations and non-contact pointing in research, medicine and industry. Sturdy black all-metal pen-shape housing.

Length: approx. 140 mm (5.5 in.)

The bright light dot is clearly visible in daylight.

Wave length 635-670 nm,
output power < 1 mW, safety class 2.

Range approx. 150 m (165 yd.).

Batteries included (2 x 1.5 V AAA-type).

Trimmers

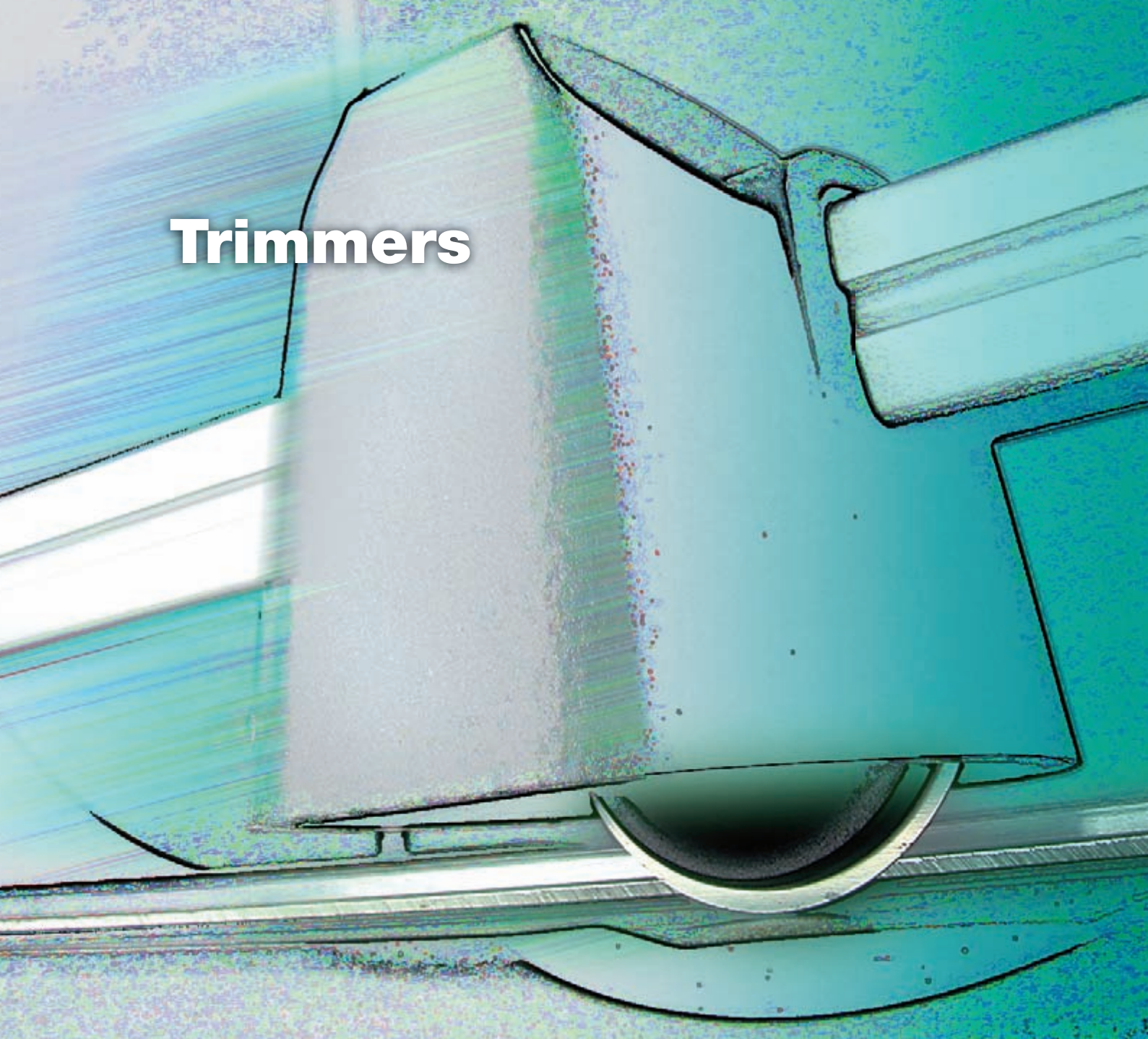

Cutting Edge



According to the dictionary „cutting edge“ means „the edge of a cutting tool in contact with the work during a machining operation“. And that’s the definition we will use. But for „cutting edge“ you might also find explanations like „up-to-date“ or „state-of-the-art“ or „leading position“, and here we are right again.

Those who „do“ pictures themselves, either in a photo lab or with an ink jet printer, need a trimmer. When you consider, what can be „produced“ with your computer using up-to-date

printing software – business cards, greeting cards, CD inlays and much more – a clean and precise cut is the minimum you should grant to your own printout.

Trimmers using a rotary blade offer a lot of advantages and are especially safe.

Cutting quality is definitely the most important issue, this means a clean and accurate cutting edge.

Blade, counter-blade and the guiding of the cutting head are the crucial factors. Additional features like format markings, scales, grid patterns and guide rails make positioning and aligning easy.

Cutting length, cutting capacity and table size are the determining factors in choosing the best trimmer. Whether you use the trimmer as a professional tool or just with your hobby: in any case you can find a suitable trimmer on the following pages – so trim up your prints.

4313-14 „hobby cut“ Safety Trimmer

With self-sharpening circular blade in closed plastic housing. Automatic paper clamping at cutting position. Transparent paper-holding strip. Two angle stops with cm and inch scales. Sturdy metal base board with printed fine grid, scales, format and angle markings.

4313: hobby cut 3

Cutting length: approx. 330 mm (13 in.)
Cutting thickness: max. 1 mm (0.04 in.)
Dimensions (WxHxD): approx. 450 x 85 x 210 mm (17.7 x 3.3 x 8.3 in.)

4314: hobby cut 4

Cutting length: approx. 460 mm (18.1 in.)
Cutting thickness: max. 1 mm (0.04 in.)
Dimensions (WxHxD): approx. 580 x 85 x 210 mm (22.8 x 3.3 x 8.3 in.)

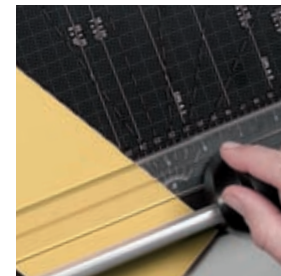
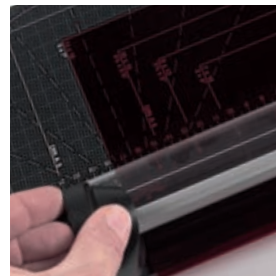



4306-07 „easy cut“ Safety Trimmer

With ground circular blade placed in a closed plastic housing. Transparent pressure rail for automatic paper clamping at cutting position. Sturdy metal base board with scales, format and angle markings.

4306: easy cut 1

Cutting length: approx. 320 mm (12.6 in.)
Max. cutting thickness: 1.0 mm (0.04 in.)
Dimensions: approx. 44 x 7 x 19 cm
(17.3 x 2.8 x 7.5 in.)

4307: easy cut 2

Cutting length: approx. 450 mm (17.7 in.)
Max. cutting thickness: 0.8 mm (0.03 in.)
Dimensions: approx. 57 x 7 x 19 cm
(22.4 x 2.8 x 7.5 in.)

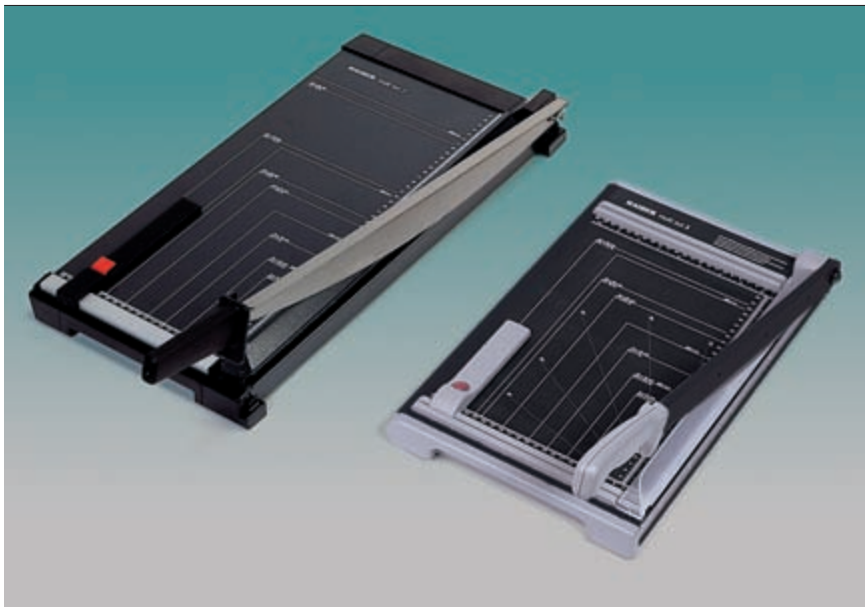

4303/4103 „multi cut“ Guillotine Cutter

Safety trimmer with honed top and bottom blades. Hand pressing rail. Angle guide with cm/inch scale and detachable magnetic back stop.

Sturdy base board with cm/inch scale and format markings.

4303: multi cut 3

Cutting length: 340 mm (13.4 in.)
Cutting thickness: 1.5 mm (0.06 in.)
Table size exterior dimensions:
45 x 28.5 cm (17.7 x 11.2 in.)

4103: multi cut 2

Cutting length: 460 mm (18.1 in.)
Cutting thickness: 1.5 mm (0.06 in.)
Table size exterior dimensions:
55 x 28 cm (21.7 x 11 in.)

4317-19 „profi cut“ Safety Trimmer

Self-sharpening circular blade in closed plastic housing. Grinded counter-blade. Automatic paper clamping at cutting position. Transparent paper-holding strip. Angle stop with cm and inch scales and detachable magnetic back stop. Base plate with cm and inch scales and format markings. Provisions for wall mounting.

4317: profi cut 1
Cutting length: 360 mm (14.2 in.)
Cutting thickness: 2 mm (.08 in.)
Dimensions 555 x 92 x 367 mm
(WxHxD): (21.8 x 3.6 x 14.4 in.)

4318: profi cut 2
Cutting length: 510 mm (20.1 in.)
Cutting thickness: 2 mm (.08 in.)
Dimensions 705 x 92 x 367 mm
(WxHxD): (27.8 x 3.6 x 14.4 in.)

4319: profi cut 3
Cutting length: 720 mm (28.3 in.)
Cutting thickness: 2 mm (.08 in.)
Dimensions 915 x 92 x 367 mm
(WxHxD): (36 x 3.6 x 14.4 in.)





4323-24 „XL Cut“ Safety Trimmer

Cutter for large-format prints, posters and other large-sized papers.

Ground circular blade placed in a closed plastic housing. Ground counter-blade. Automatic paper clamping at cutting position with transparent paper-holding strip. Angle guides on both sides, adjustable back-stop. Metal cutting table with various guides. Provisions for wall mounting.

4323: Cutting length: 92 cm (36.2 in.)
Max. cutting thickness: 2.5 mm (0.1 in.)
Dimensions: 112 x 38.4 cm
(44.1 x 15.1 in.)
Weight: 7.2 kg (15.9 lbs.)

4324: Cutting length: 130 cm (51.2 in.)
Max. cutting thickness: 2.0 mm (0.08 in.)
Dimensions: 150 x 38.4 cm
(59.1 x 15.1 in.)
Weight: 9.4 kg (20.7 lbs.)



4301 Guillotine Cutter

For application photos and passport photos. Incl. extension board with slidable gauge.

Cutting length: approx. 15 cm (6 in.)
Cutting height: max. 0.3 mm
Dimensions
(WxHxD): approx. 22.5 x 3.2 x 12.5 cm
(8.9 x 1.3 x 4.9 in.)
(without gauge)



Camera Accessories

„Discover the Possibilities“

Basically today's cameras do the same as always: they shoot pictures. But there is a radical change in the way they do it and in the possibilities to use small tools to provide a technically perfect image tailored to the photographer's requirements. Image stabilization, face detection and „smile shutter“ mode are only the tip of the iceberg of built-in helpers. But nevertheless there

is still plenty of room for reasonable accessories: for the LCD screen, for the lens, for the shutter release. Tripods, ball heads, shoulder straps and filters are equally useful. Accessories expand the possibilities of your camera and are sometimes indispensable in certain situations or to achieve desired results.

Here is a short survey:

- LCD accessories see page 145



- Lens accessories see page 150



- Shutter releases see page 156



- Shoulder and wrist straps and more carrying accessories see page 160



- Bags see page 164



- Tripods, heads, levels etc. see page 166



- Flash accessories see page 176



- More accessories see page 183



- Video transfer see page 186



6084
SL3 LCD Viewfinder

Screen attachment shaped like a light shield with a built-in loupe for DSLRs and CSCs with 3" LCD. Allows for perfect framing and focus control when shooting and trouble-free image review under any ambient light condition. Loupe with 2.3x magnification, lens with coating on each side and eyesight adjustment via large knurled wheel. Extensive, highly flexible eye cup.

Attaches on a self-adhesive holding frame on which the viewfinder clicks into place. Eye cup can be adjusted for left or right eye viewing.

Outside dimensions (w/o eye cup, WxHxD):
75 x 63 x 85 mm (3 x 2.5 x 3.3 in.)

Weight: approx. 105 g (3.7 oz.)





6054/74 „digiShield²“ LCD Screen Glare Shield

For digital compacts with LCD up to 2.7”*.

Shields lateral and angular incidence of light from the LCD monitor and improves the visibility of the monitor image.

Coil spring supported side flaps will keep the glare shield in opened position.

Folds down completely and serves also as a cover and a screen protector.

Fits many digital compact cameras. The shield is attached to the tripod socket using a suitable adapter plate. Regardless of the position of the tripod socket on the camera the glare shield can be attached so that it is positioned properly on the monitor and fits tightly to the camera body. It can be moved sideways and adjusted in height.

Includes three adapter plates, flat mounting screw and tripod adapter screw to use the camera together with the glare shield on a tripod.

6054: black

6074: silver

* Eventually minor border covering with 2.7"



6055/75
„digiShield³“
LCD Screen Glare Shield

For digital compacts with 3.0" LCD screen.

Shields lateral and angular incidence of light from the LCD monitor and improves the visibility of the monitor image on digital cameras.

Folds down completely and serves also as a cover and a screen protector. Coil spring supported side flaps will keep the glare shield in opened position.

To ease the operation of a touch screen monitor the complete glare shield flips up by releasing a lock rail, no matter if it is open or folded down.

The shield is attached to the tripod socket with a screw with thin head or an adapter screw, that has an additional tripod thread. Regardless of the position of the tripod socket on the camera the glare shield can be attached so that it is positioned properly on the monitor and fits tightly to the camera body.

Supplied with 3 different adapter plates, two different thin screws and an adapter screw with tripod thread.

6055: black

6075: silver





6076/78 LCD Screen Protective Film

For use with digital cameras, mobile phones and PDAs. Protects the screen from scratches, dirt and fingerprints. Suitable for touch-screens. Can be removed without residues.

6076: Set with three 4 x 3" (10 x 8 cm) sheets, each, with cutting lines for required size. Comes with cleaning cloths and a squeegee card to apply the film.

6078: For 3" LCD screens. Can be cut to fit smaller screens. Rounded corners. 3 pieces.



6079-82/6093-94 „Crystal Clear“ LCD Screen Protecting Film

Layer composition

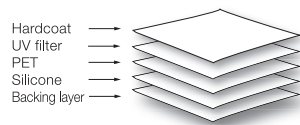

High-quality film for use on LCD screen of digital cameras. Protects from scratches, dirt and fingerprints. Almost invisible.

Hard coated PET film with UV protection, scratch resistant. Optimized for touch-screens. Attaches by adhesion due to silicone coating and can be removed without residues. Easy to apply, no bubbling. 1 piece.

6079: for 2.7" screens

6080: for 3.0" screens

6081: for 3.5" screens

6082: for 4.0" screens

16:9 aspect ratio

6093: for 3.0" screens

6094: for 3.5" screens



6085-92/6095-97/6616-51/6664-76 „Antireflex“ LCD Screen Protecting Film

High-quality film for use on LCD screen of digital cameras. Protects from scratches, dirt and fingerprints. Glare-free due to antireflection coating.

Hard coated PET film with UV protection, scratch resistant. Optimized for touch-screens. Attaches by adhesion due to silicone coating and can be removed without residues. Easy to apply, no bubbling. 1 piece.

Layer composition

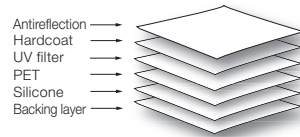

6085: for 2.5" screens
6086: for 2.7" screens
6088: for 2.8" screens
6087: for 3.0" screens
6090: for 3.5" screens
6092: for 4.0" screens
16:9 aspect ratio

6095: for 3.0" screens
6097: for 3.5" screens

Also available custom-cut for these SLRs and CSCs:

6616: for Canon 7D *
6618: for Canon 60D / 600D / Panasonic TZ41
6619: for Canon 1100D
6625: for Nikon D3100
6626: for Olympus E450 / E420 / E520
6627: for Olympus E620
6628: for Panasonic G3 / G5 / GF3 / GF5 / GX1 / FZ48
6629: for Panasonic TZ18 / 22 / 25 / 31 / 36, Leica V-Lux 30 / 40, Nikon P510
6630: for Panasonic GH1 / G1
6631: for Panasonic GF1 / GF2 / FZ45 / LX5 / LX7, Leica D-Lux 5 / 6
6632: for Panasonic GH2 / G2 / FZ100, FZ150 / FZ200, Leica V-Lux 2/3
6634: for Sony Alpha 230 / 290 / 450
6636: for Sony Alpha 500 / 550
6637: for Sony Alpha 580
6638: for Sony Alpha 33 / 35 / 55 and NEX 3 / 3N / C3 / 5 / 5N / 6 / 7 / F3
6640: for Sony Alpha 57 / 65 / 77, DSC-HX200
6642: for Olympus OM-D E-M5
6643: for Nikon D600 *
6644: for Nikon D3200
6645: for Nikon D7000 *
6646: for Nikon D5100 / D5200
6648: for Nikon 1 V1, Fujifilm HS 30
6649: for Nikon D800 *
6650: for Canon 5D Mark III
6651: for Canon 650D
6664: for Canon EOS M
6665: for Nikon 1 J2, 1 J3, 1 V2
6667: for Canon 6D
6668: for Canon 1D C / 1D X *
6669: for Nikon D4 *
6670: for Nikon D7100 *
6675: for Canon 100D
6676: for Canon 700D

* additional film(s) for status LCD(s) included



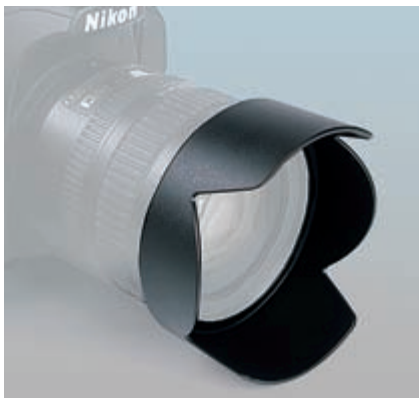
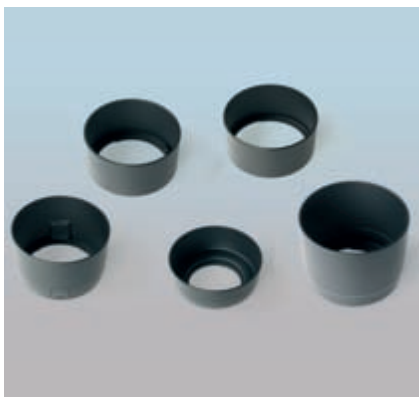

6865-99 Lens Hood

- 6865:** CW88C (replaces Canon EW-88C), for Canon EF 24-70/2.8L II USM
- 6866:** CT67 (replaces Canon ET-67), for Canon EF 100/2.8 USM/Makro USM
- 6868:** CT73 (replaces Canon ET-73), for Canon EF 100/2.8 L Makro IS USM
- 6869:** CT73B (replaces Canon ET-73B), for Canon EF 70-300/4-5.6 L IS USM, white
- 6870:** CT74 (replaces Canon ET-74), for Canon EF 70-200/4.0 L (IS) USM, white
- 6871:** CT83C (replaces Canon ET-83C), for Canon EF 100-400/4.5-5.6 L IS USM, white
- 6873:** CT87 (replaces Canon ET-87), for Canon EF 70-200/2.8 L IS II USM, white
- 6874:** CW83F (replaces Canon EW-83F), for Canon EF 24-70/2.8 L USM
- 6875:** CW83G (replaces Canon EW-83G), for Canon EF 28-300/3.5-5.6 L IS USM, white
- 6876:** CW83H (replaces Canon EW-83H), for Canon EF 24-105/4.0 L IS USM
- 6878:** CW88 (replaces Canon EW-88), for Canon EF 16-35/2.8 L II USM
- 6879:** CW78E (replaces Canon EW-78E), for Canon EF-S 15-85/3.5-5.6 IS USM
- 6880:** CW60C (replaces Canon EW-60 C), for Canon EF 28-90/4-5.6 II (USM), Canon EF 28-80 (II/USM), Canon EF-S 18-55/3.5-5.6 IS (USM/II), Canon EF 22-55/4.0-5.6
- 6881:** CW73II (replaces Canon EW-73 II), for Canon EF 24-85/3.5-4.5 (USM)
- 6882:** CW78BII (replaces Canon EW-78 B II), for Canon EF 28-135/3.5-5.6 IS USM
- 6883:** CS71II (replaces Canon ES-71 II), for Canon EF 50/1.4 USM
- 6884:** CT65III (replaces Canon ET-65 III), for Canon EF 85/1.8 (USM), Canon EF 100/2.0 USM, Canon EF 135/2.8 Soft-Fokus, Canon EF 70-210/3.5-4.5 USM, Canon EF 100-300/4.5-5.6 (USM)
- 6885:** CT65B (replaces Canon ET-65 B), for Canon EF 70-300/4.5-5.6 DO IS USM, Canon EF 70-300/4.0-5.6 IS USM
- 6886:** CT67B (replaces Canon ET-67 B), for Canon EF-S 60/2.8 Macro USM
- 6887:** CS62 (replaces Canon ES-62), for Canon EF 50/1.8 II
- 6888:** CT60III (replaces Canon ET-60 III), for Canon EF 75-300/4.0-5.6 III (USM), Canon EF 90-300/4.5-5.6 (USM), Canon EF-S 55-250/4.0-5.6 IS
- 6889:** CW73B (replaces Canon EW-73 B), for Canon EF-S 17-85/4.0-5.6 IS USM, Canon EF-S 18-135/3.5-5.6 IS
- 6890:** CW78D (replaces Canon EW-78 D), for Canon EF-S 18-200/3.5-5.6 IS, Canon EF 28-200/3.5-5.6 (USM)
- 6891:** CW83E (replaces Canon EW-83 E), for Canon EF-S 10-22/3.5-4.5 USM, Canon EF 17-40/4.0L USM, Canon EF 16-35/2.8L USM (old version)
- 6892:** CW83J (replaces Canon EW-83 J), for Canon EF-S 17-55/2.8 IS USM
- 6893:** NB32 (replaces Nikon HB-32), for Nikon AF-S DX 18-70/3.5-4.5G IF-ED, Nikon AF-S 18-105/3.5-5.6 G ED VR, Nikon AF-S 18-135/3.5-5.6 IF-ED
- 6894:** NB45 (replaces Nikon HB-45), for Nikon AF-S DX 18-55/3.5-5.6G ED/EDII/VR
- 6895:** NB37 (replaces Nikon HB-37), for Nikon AF-S DX 55-200/4-5.6 G ED VR
- 6899:** SH108 (replaces Sony ALC-SH 108), for Sony DT 18-55/3.5-5.6 SAM

Dedicated lens hoods for specific lenses of digital SLRs. Can also be mounted in reversed position on the lens for saving space (except 6887).

Made from impact-resistant plastic.

6829/31
Lens Hood for Pancake Lenses

Made of matte black rubber. Rotating connecting ring with metal mount and locking screw. Includes lens cap for use with mounted lens hood.

6829: For Panasonic Lumix G with 1.7/20 mm or 2.5/14 mm Pancake lens, also for JVC and Panasonic camcorders with 46 mm filter thread.

6831: For Olympus Pen with M.Zuiko Digital 2.8/17 mm or M.Zuiko Digital 3.5-5.6/14-42 mm II Pancake lens, also for Panasonic Lumix G X Vario PZ 3.5-5.6/14-42 mm Pancake lens and Canon, JVC and Sony camcorders with 37 mm filter thread.

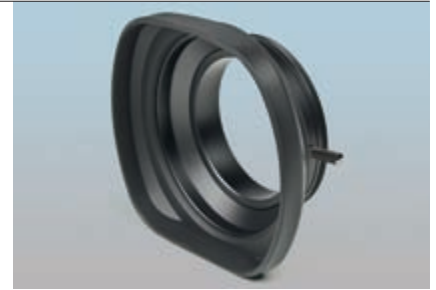

6820-27/6850-53
3-in-1 Lens Hood

For lenses with 28 to 200 mm focal length (35 mm equivalent). Made of matte black silicone, foldable. With light baffles. Metal screw-in mount. Filter thread.

6850: \varnothing 37 mm

6851: \varnothing 43 mm

6853: \varnothing 46 mm

6820: \varnothing 49 mm

6821: \varnothing 52 mm

6822: \varnothing 55 mm

6823: \varnothing 58 mm

6824: \varnothing 62 mm

6825: \varnothing 67 mm

6826: \varnothing 72 mm

6827: \varnothing 77 mm

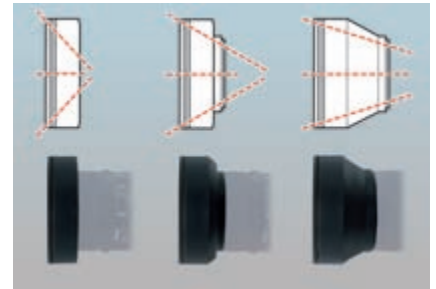



6833-48 Snap-On Lens Cap

Reliable protection by clamp-on design for snapping on to filter thread of lens. With lens cap keeper. Can also be used with lens hood mounted.

6845: ø 37 mm	6837: ø 62 mm
6847: ø 43 mm	6838: ø 67 mm
6848: ø 46 mm	6839: ø 72 mm
6833: ø 49 mm	6840: ø 77 mm
6834: ø 52 mm	6841: ø 82 mm
6835: ø 55 mm	6842: ø 86 mm
6836: ø 58 mm	

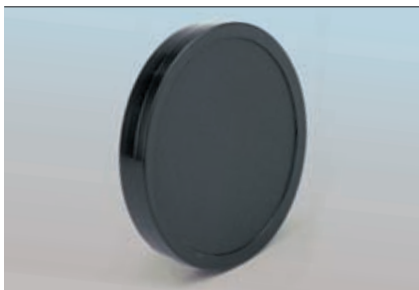

6900-92 Lens Cap

Diameters are the **inside dimensions** of the lens cap. This corresponds with the outside diameter of the lens (or filter) which is covered with the lens cap.

Slip lid, made of flexible plastic, black.

6915: ø 15 mm	6948: ø 48 mm
6916: ø 16 mm	6949: ø 49 mm
6917: ø 17 mm	6950: ø 50 mm
6918: ø 18 mm	6951: ø 51 mm
6919: ø 19 mm	6952: ø 52 mm
6920: ø 20 mm	6953: ø 53 mm
6921: ø 21 mm	6954: ø 54 mm
6922: ø 22 mm	6955: ø 55 mm
6923: ø 23 mm	6956: ø 56 mm
6924: ø 24 mm	6957: ø 57 mm
6925: ø 25 mm	6958: ø 58 mm
6926: ø 26 mm	6959: ø 59 mm
6928: ø 28 mm	6960: ø 60 mm
6929: ø 29 mm	6961: ø 61 mm
6930: ø 30 mm	6962: ø 62 mm
6931: ø 31 mm	6963: ø 63 mm
6932: ø 32 mm	6964: ø 64 mm
6933: ø 33 mm	6965: ø 65 mm
6934: ø 34 mm	6967: ø 67 mm
6935: ø 35 mm	6968: ø 68 mm
6936: ø 36 mm	6970: ø 70 mm
6937: ø 37 mm	6971: ø 71 mm
6938: ø 38 mm	6972: ø 72 mm
6939: ø 39 mm	6974: ø 74 mm
6940: ø 40 mm	6975: ø 75 mm
6941: ø 41 mm	6977: ø 77 mm
6942: ø 42 mm	6980: ø 80 mm
6943: ø 43 mm	6982: ø 82 mm
6944: ø 44 mm	6985: ø 85 mm
6945: ø 45 mm	6990: ø 90 mm
6946: ø 46 mm	6900: ø 100 mm
6947: ø 47 mm	6992: ø 120 mm



6056

6056 Lens Cap Keeper

Protects against loss of lens cap. A self-adhesive plate is stuck to the lens cap and attached to the lens by an elastic cord.

6605-11
„Vivicap“ White Balance Filter

Snap-on filter with specially designed prism structured surface for white-balancing of digital cameras and camcorders. Easy to use clamping mechanism provides for quick installation and removal. Serves also as a lens cap and can also be attached when a lens hood is used.

- 6605:** ø 52 mm
- 6606:** ø 55 mm
- 6607:** ø 58 mm
- 6608:** ø 62 mm
- 6609:** ø 67 mm
- 6610:** ø 72 mm
- 6611:** ø 77 mm

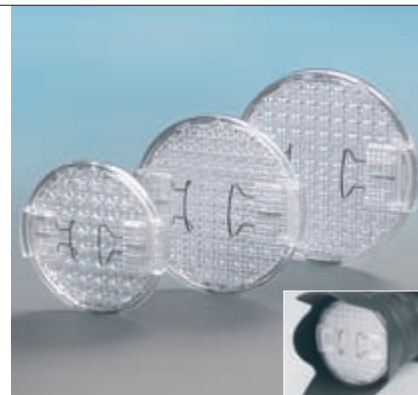

6531-38
Lens Rear Cap

Made from impact-resistant plastic, black.

- 6531:** for Canon EOS
- 6532:** for Minolta MD
- 6533:** for Sony Alpha / Minolta AF
- 6535:** for Nikon
- 6536:** for Olympus OM
- 6537:** for Pentax K
- 6538:** for Micro Four Thirds
(Olympus/Panasonic)

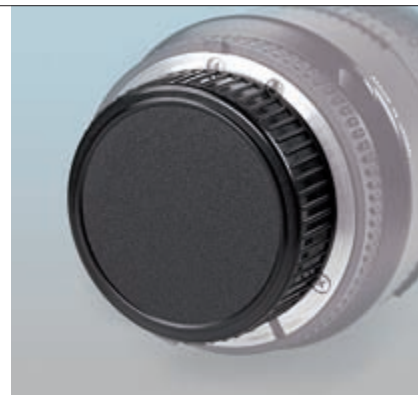

6521-28
Camera Body Cap

Made from impact-resistant plastic, black.

- 6521:** for Canon EOS
- 6522:** for Minolta MD
- 6523:** for Sony Alpha / Minolta AF
- 6525:** for Nikon
- 6526:** for Olympus OM
- 6527:** for Pentax K
- 6528:** for Micro Four Thirds
(Olympus/Panasonic)





6542-99 Filter Adapter Ring

For mounting filter and front attachments to lenses with deviating mounting threads. Precision metal rings with dull black surface (6585: silver finish).

Lens thread – Filter thread

6547: 27 - 37	6555: 52 - 49
6584: 28 - 37	6556: 52 - 55
6585: 30 - 37	6557: 52 - 58
6586: 30.5 - 37	6558: 52 - 62
6588: 34 - 37	6561: 55 - 52
6589: 37 - 43	6562: 55 - 58
6542: 37 - 46	6563: 55 - 62
6543: 37 - 49	6564: 55 - 67
6544: 37 - 52	6565: 58 - 52
6591: 39 - 43	6567: 58 - 55
6592: 40.5 - 43	6568: 58 - 62
6593: 40.5 - 46	6566: 58 - 67
6594: 40.5 - 49	6569: 62 - 58
6548: 40.5 - 52	6570: 62 - 67
6599: 41.5 - 46	6571: 62 - 72
6595: 43 - 46	6572: 62 - 77
6596: 43 - 49	6573: 67 - 58
6549: 43 - 52	6574: 67 - 72
6545: 46 - 49	6575: 67 - 77
6546: 46 - 52	6576: 72 - 58
6597: 46 - 55	6577: 72 - 77
6550: 49 - 52	6578: 77 - 58
6551: 49 - 55	6579: 77 - 82
6552: 49 - 58	

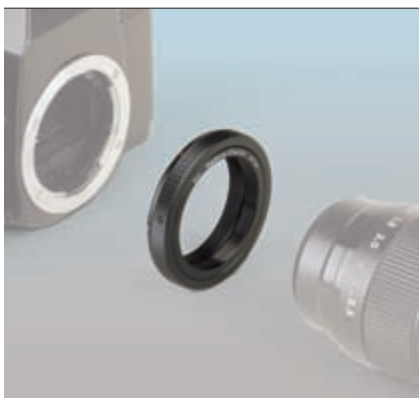

6508-19 T-Mount Adapter

Thread adapter for mounting lenses, bellows, slide duplicators, focussing helical mounts, etc. with T-mount on various cameras.

6508: Micro Four Thirds (Olympus/Panasonic)
6509: Sony NEX
6511: Pentax K
6512: Nikon
6513: Minolta MD
6514: Canon FD
6515: Olympus OM
6517: Yashica / Contax
6518: Sony Alpha / Minolta AF
6519: Canon EOS (Autofocus)

6506
„Digital“ Slide Duplicator

Suitable for digital SLRs and digital compacts with front lens thread. Attaches to the filter thread of the lens. 52 mm connecting thread. 58-52 mm adapter ring included. Adapter rings for other connecting threads see below.

Detachable achromatic 10 dioptre macro lens, can also be used separately. A lens with a focal length between 80 and 120 mm (based on full-frame sensor) is required to achieve full size copies, larger frames require higher focal length.

Includes holder for two 35 mm slides.

Length: approx. 12.5 cm (4.9 in.)

Suitable adapter rings:

6561: 55 – 52 mm

6565: 58 – 52 mm (included)

6569: 62 – 58 mm

6573: 67 – 58 mm

6576: 72 – 58 mm

6578: 77 – 58 mm



6507
Film Strip Carrier

For six 35mm negatives or unmounted slides. For use with Slide Duplicator 6506.

Length: approx. 27 cm (10.6 in.)

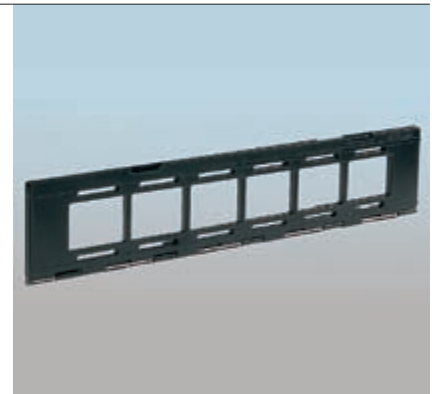



6161

6161-62 „Twin1 R3“ Wireless/Wired Remote Shutter Release

6161: Twin1 R3-UT, for Canon 60D, 100D, 300D, 350D, 400D, 450D, 500D, 550D, 600D, 650D, 700D, Pentax *istD, *istDL(2), *istDS(2), K-5, K-5 II(S), K-7, K10D, K20D, K-30, K100D, K110D, K200D, Samsung GX-1L, GX-1S, GX-10, GX-20, IR only: Canon EOS M, Pentax K-m, K-r, K-x, X5

6162: Twin1 R3-UTN2, for Nikon D90, D600, D3200, D5000, D5100, D5200, D7000, D7100, Coolpix A, P7700, IR only: Nikon D40(x), D50, D60, D70(s), D80, D3000, 1 J1, 1 J2, 1 V1, 1 V2, Coolpix P7100

Suitable for many (D)SLR and compact system cameras with built-in infrared receiver. Depending on the type of camera, the Twin1 R3 transmitter can be used as a wireless IR or as a wired remote shutter release. Half-shutter mode (activates TTL metering and autofocus prior to shooting), delay shot mode (wireless), bulb shot (wireless and wired). The single, large release button provides for error-free operation. Can also be used as a flash light, built-in LED works either continuously or blinks periodically. 88 x 26 x 17 mm (3.5 x 1 x 0.7 in.), 19 g (0.7 oz.).

Maximum operating range: 50 m (150 ft.) (Nikon, Pentax, Samsung), 25 m (75 ft.) (Canon).

Includes 1 m (3 ft.) release cable, 23A battery (12 V) and key ring.



6167-71 „Twin1 R4“ Wireless/Wired Remote Shutter Release

6167: Twin1 R4N, for Nikon and Fuji cameras with 10 pin connector.

6168: Twin1 R4U, for Canon, Pentax, Samsung and Sigma cameras with 2.5 mm jack plug connector.

6169: Twin1 R4C, for Canon cameras with N3 connector.

6170: Twin1 R4S, for Sony and Minolta cameras with 3 pin connector.

6171: Twin1 R4P, for Panasonic and Leica cameras with 2.5 mm jack plug connector.

Suitable for many (D)SLR and compact system cameras. Kit contains transmitter and receiver, 1 m (3 ft.) release cable and more accessories.

Transmitter can be used as a wireless IR or as a wired remote shutter release. Half-shutter mode (activates TTL metering and autofocus prior to shooting), delay shot mode (wireless), bulb shot (wireless and wired). The single, large release button provides for error-free operation. Can also be used as a flash light, built-in LED works either continuously or blinks periodically. 88 x 26 x 17 mm (3.5 x 1 x 0.7 in.), 19 g (0.7 oz.).

Twin 1 R4U, R4C, R4S, R4P receiver: Compact unit with two red indicator LEDs. 40 x 30 x 25 mm, 11 g (1.6 x 1.2 x 1 in., 0.4 oz.). Includes spare battery.

Twin1 R4N receiver: Extremely small and light-weight (only 6 g / 0.2 oz.), red indicator LED. Powered by the camera, needs no extra batteries. 15 x 15 x 22 mm (0.6 x 0.6 x 0.9 in.).

Maximum working range: 100 m (330 ft.)

Batteries (included):

Transmitter: 23A type (12V)

Receiver: CR2032 type (3V) (except R4N)

Please check our website at www.kaiser-fototechnik.de for an up-to-date camera compatibility list.



6167

6177-81

„Twin1 RF“ Wireless/Wired Remote Shutter Release

- 6177:** Twin1 RFU, for Canon, Pentax, Samsung and Sigma cameras with 2.5 mm jack plug connector.
- 6178:** Twin1 RFC, for Canon cameras with N3 connector.
- 6179:** Twin1 RFN, for Nikon and Fuji cameras with 10 pin connector.
- 6180:** Twin1 RFS, for Sony and Minolta cameras with 3 pin connector.
- 6181:** Twin1 RFP, for Panasonic and Leica cameras with 2.5 mm jack plug connector.

Please check our website at www.kaiser-fototechnik.de for an up-to-date camera compatibility list.

Suitable for many (D)SLR and compact system cameras. Kit contains transmitter and receiver, 1 m (3 ft.) release cable and more accessories.

Transmitter can be used as a wireless radio-controlled or as a wired remote shutter release. Half-shutter mode (activates TTL metering and autofocus prior to shooting), delay shot mode (wireless), bulb shot (wireless and wired). The single, large release button provides for error-free operation. Can also be used as a flash light. 88 x 26 x 17 mm (3.5 x 1 x 0.7 in.), 19 g (0.7 oz.).

Twin 1 RFU, RFC, RFS, RFP receiver:

Compact unit with two red indicator LEDs. 40 x 30 x 25 mm, 11 g (1.6 x 1.2 x 1 in., 0.4 oz.). Includes spare battery.

Twin1 RFN receiver: Extremely small and lightweight (only 6 g / 0.2 oz.), red indicator LED. Powered by the camera, needs no extra batteries. 15 x 15 x 22 mm (0.6 x 0.6 x 0.9 in.).

Maximum working range: 100 m (330 ft.).
Operating frequency: 2.4 GHz. Batteries (included): Transmitter: 23A type (12V). Receiver: CR2032 type (3V) (except RFN).



6131-35

„Twin1 ISR“ Wired Remote Shutter Release

- 6131:** Twin1 ISR iC, for Canon, Pentax, Samsung and Sigma cameras with N3 or 2.5 mm jack plug connector.
- 6133:** Twin1 ISR iN, for Nikon and Fuji cameras with 10 pin connector and for Nikon D70s, D80, D90, D600, D3100, D3200, D5000, D5100, D5200, D7000, D7100, Coolpix P7700, A.
- 6134:** Twin1 ISR i04, for Sony and Minolta cameras with 3 pin connector.
- 6135:** Twin1 ISR i07, for Panasonic and Leica cameras with 2.5 mm jack plug connector.

Please check our website at www.kaiser-fototechnik.de for an up-to-date camera compatibility list.

Remote release for interval, continuous, bulb and time shutter control.

Normal shutter release works also without or with empty battery. Delay start is supported. Timer and interval time ranges from 1 second to 99 hours, 59 minutes, 59 seconds. Exposure numbers in interval and continuous mode range from 1 to 9.999. 4-way-operation button. Illuminated triple-spaced LCD, three types of display mode. Easy user interface for all settings.

All buttons can be locked to prevent unintentional operation. Beep sound can be switched off. Low battery warning.

Battery (included): 3 V (CR 2032)
Operating time: approx. 2 months
Release cable length: 1 m
Dimensions: 23 x 16 x 100 mm
(0.9 x 0.6 x 3.9 in.)
Weight: 26 g (0.9 oz.) (incl. batteries)





6187-93 „MonoCR“ Wired Remote Switch

Compact ergonomically designed remote release. Two-stage release button (half-shutter mode activates TTL metering and autofocus prior to shooting). Release button can be locked for bulb shot, with color indicator. Release cable can be detached and extended by optional 6185 extension cable. No battery required.

Length of coiled cable (extended): 50 cm
(19.7 in.)

Dimensions: 105 x 34 x 23 mm
(4.1 x 1.3 x 0.9 in.)
Weight: 30 g (1.1 oz.).



Please check our website at www.kaiser-fototechnik.de for an up-to-date camera compatibility list.

6187: MonoCR-C2, replaces Canon RS-60E3 and Pentax CS-205, for Canon, Pentax, Samsung and Sigma cameras with 2.5 mm jack plug connector

6188: MonoCR-C1, replaces Canon RS-80N3, for Canon cameras with N3 socket

6189: MonoCR-N1, replaces Nikon MC-30, for Nikon and Fuji cameras with 10 pin socket

6190: MonoCR-N3, replaces Nikon MC-DC2, for Nikon cameras from D90 up to D7100

6191: MonoCR-S1, replaces Sony RM-S1AM and Minolta RC-1000, for Sony and Minolta cameras with 3 pin socket

6192: MonoCR-P1, replaces Panasonic DMW-RSL1, for Panasonic and Leica cameras with 2.5 mm jack plug connector

6193: MonoCR-O2, replaces Olympus RM-UC1, for Olympus PEN, OM-D, E series (in part)



6185 Extension Cable

For MonoCR wired release switches. Also suitable for Twin1 R3, Twin1 R4, Twin1 RF and Twin1 ISR release cables.

Length: 2 m (6 ft.). Several cables can be used in connection to get longer range.



6101-02 Cable Release

Black fabric covering.

6101: Length 25 cm (9.8 in.)

6102: Length 50 cm (19.7 in.) threaded rotating tip



6103/05 Cable Release

With locking screw.
Black fabric covering.

6103: Length 15 cm (6 in.)

6105: Length 50 cm (19.7 in.), threaded rotating tip

6108
Cable Release

With auto-lock disc.
Black fabric coating.
Length 50 cm (19.7 in.),
threaded rotating tip

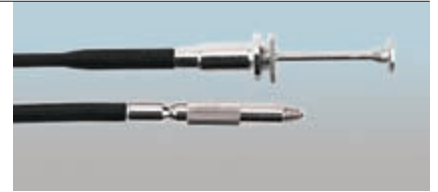

6184
Professional Cable Release

Upper part with formed grip and auto-lock disc. Interchangeable release with black plastic covering and threaded rotating tip.
Release travel adjustable.
Length: 50 cm (19.7 in.)



6148
Cable Release Adapter

For connecting the standard cable release to cameras with awkwardly placed connecting thread. L- shape.
Threaded rotating tip.



6154
Cable Release Adapter

For the use of conventional cable releases on cameras (e.g. auto focus or compact cameras) which have only a socket to connect an electric release, or do not have a cable release bush.



6143-44
Pneumatic Remote Release

6143: With 5 m (16 1/2 ft.) long release tube and winding reel. 15 cm (5.9 in.) long cable release with threaded rotating tip.

6144: With 10 m (33 ft.) long release tube, which can be divided in 2 x 5 m (2 x 16 1/2 ft.). 15 cm (5.9 in.) long cable release with threaded rotating pin. With winding reel and plastic box.





6780
„Neopren“ Camera Strap

For cameras with two strap connectors. Shoulder pad made from flexible high-grade Neoprene, edges covered with fabric. High carrying comfort. Ergonomically shaped, conforms to shoulder or neck. Durable and sturdy. Length adjustable. End sections can be detached from the Neoprene part and reconnected to serve as a wrist strap.

Length: 140 cm (55 in.) max.
Width: 65/40 mm (2.6 / 1.6 in.)

Colour: black



6771
Professional Camera Strap

Highly durable woven strap with non-slip shoulder pad on the underside. Length adjustment at both ends. For cameras with round or flat eyelets.

Width: approx. 30 mm (1.2 in.)
Length: approx. 100 cm (39.4 in.)

Color: black



6791
Professional Camera Strap

Extremely hard-wearing woven strap with widened shoulder area. Non-slip shoulder area. Length can be adjusted on both sides. For cameras with round or flat eyelets. Width approx. 12/50 mm (.5/2 in.), length approx. 110 cm (3 ft. 7 in.)

Color: black



6751
Camera Strap

Made of high-grade polyester webbing. With woven-in rubber filaments on inside to prevent slipping. Ends of strap with quick-release safety locks. Length adjustable. For cameras with round or flat eyelets. Width: approx. 30 mm (1.2 in.)
Length: approx. 110 cm (3 1/2 ft.)
Color: black



6742
„Neopren“ Camera Strap

Carrying strap for digital compacts with single strap connector. Shoulder pad made of high-grad soft Neoprene, edges covered with fabric. High carrying comfort. Ergonomically shaped, conforms to shoulder or neck. Quick-release lock. Length: approx. 53 cm (20.9 in.)
Width: approx. 45/30 mm (1.8 / 1.2 in.)

6778-79
„Adventure“ Camera Strap

Heavy-duty woven strap for cameras with two round or flat fastening eyes. Inner surface with non-slip protection. Adjustable length, max. 145 cm (57.1 in.).

Detachable end sections can be reconnected to serve as a wrist strap.

6778: Denim, width 35 mm (1.4 in.)

6779: Khaki, width 38 mm (1.5 in.)



6752-55
Genuine Leather Carrying Strap

For digital compacts with one fastening eye. Also suitable for mobile phones, MP3 players etc.

Width: 10 mm (0.4 in.)

Length: approx. 46 cm (18.1 in.)

6752: black

6753: red

6754: olive

6755: brown



6747-48
„Reflex“ Neck Strap

Narrow reflective shoulder strap.

For digital compact cameras with single strap connector, also suitable for mobile phones, MP3 players, etc. Quick-release lock.

Length: approx. 47 cm (18.5 in.)

Width: 1 cm (0.4 in.)

6747: silver/black

6748: silver/red



6745-46
Neck Chain / Carrying Strap

For cameras with single strap connector, also suitable for mobile phones, MP3 players, etc.

6745: Gracefully built silver chain with clear plastic cover. Goes perfectly with the styling of today's digital compacts. Can be easily detached. Length: approx. 46 cm (18.1 in.)

6746: Soft elastic textile fabric. Quick release lock. Length: approx. 49 cm (19.3 in.)

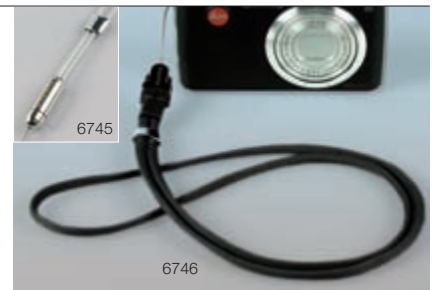



6701

6701-02 „Profi“ Camera Wrist Strap with Mini-Stand

Suitable for larger compacts, CSCs and (D)SLRs. Soft padded genuine leather hand support with adjustable fixtures.

Camera mounting plate with tripod thread and foldable legs providing a secure stand when put on table or floor. Counter-sunk fastening screw.

Non-slip camera rest.

Height of mounting plate: approx. 10 mm (0.4 in.).

6701: „Profi“ Camera Wrist Strap

6702: „Pro 2.0“ Camera Wrist Strap, with additional safeguard belt around the wrist for more safety and stability.



6702



6737-40 Genuine Leather Wrist Strap

For digital compacts with one fastening eye. Also suitable for mobile phones, MP3 players, etc.

Width: 10 mm (0.4 in.)

Length: approx. 22 cm (8.7 in.)

6737: black

6738: red

6739: olive

6740: brown



6735

6736

6735-36 Wrist Strap

For cameras with single strap connector, also suitable for many mobile phones, MP3 players, etc.

6735: Gracefully built silver chain with clear plastic cover. Goes perfectly with the styling of today's digital compacts. Can be easily detached.
Length: approx. 24 cm (9.4 in.)

6736: Soft elastic textile fabric. Quick release lock. Length: approx. 26 cm (10.2 in.)

3272
Hand Grip

For lighting units, cameras, etc.
With foam shell. 1/4" connection thread with washer made of elastic plastic, 1/4" tripod thread.
Includes snap-hook with key ring and fixture for tripod thread.
Height: approx. 120 mm (4.7 in.)



96008
Video Shoulder Pod

Combined chest and shoulder pod for camcorders. Pivoting mounting plate with 1/4" thread, securing pin and non-slip face.
Length steplessly adjustable and lockable in any position.
Folded flat the pod can stay fitted to the camcorder. Adjustable strap.



6370-76
Photo Functional Gloves

Combination of mitten and half finger gloves for perfect mobility, secure grip and ideal protection against cold.
Mitten and thumb cover can be folded back and fastened with a Velcro strip.
Made of breathable, skin friendly fleece with anti-slip coating on the palm.
Colour: black
6370: size M
6372: size L
6374: size XL
6376: size XXL





8281-89
„digiShell“ Hard Shell Camera Bag

Compact camera bags with hard shell exterior and two-way zipper. Interior accessory pocket. With belt loop, detachable carrying strap and snap hook.

„digiShell 1“,
 9.5 x 6 x 2.5 cm (3.7 x 2.4 x 1 in.)

8281: black

8282: blue

8283: grey



„digiShell 2“,
 10.8 x 6.5 x 3.3 cm (4.3 x 2.6 x 1.3 in.)

8287: black

8288: blue

8289: grey



All measurements are inside dimensions.



8255/61
„digiSkin“ Soft Leather Bags

Small belt pouches made of soft genuine leather surrounding the camera like a second skin. Velvety inner lining, interior pocket for memory card and belt loop. With magnetic catch.

8255: „digiSkin 1“, 6.0 x 9.0 x 2.6 cm
 (2.4 x 3.5 x 1.0 in.)

8261: „digiSkin 7“, 5.8 x 9.5 x 2.8 cm
 (2.3 x 3.7 x 1.1 in.)

All measurements are inside dimensions.

8825-27 „SmartLoader“ Camera Bag

Lightweight and stable bag for cameras and camcorders.

Main compartment with divider. Lid with inside mesh pocket, opens away from the body and stays open in a fixed position. Mesh pockets on both sides. Zipped front pocket with large cover and card pocket.

Padded handle. Adjustable carrying strap with shoulder pad. Metal D-rings and snap hooks. Belt loops.

8825: SmartLoader S, for megazoom cameras and camcorders. Inside dimensions (WxHxD): 10.6 x 13 x 8.7 cm (4.2 x 5.1 x 3.4 in.).

8826: SmartLoader M, for bridge cameras, CSCs and camcorders. Inside dimensions (WxHxD): 16 x 10 x 9 cm (6.3 x 3.9 x 3.5 in.).

8827: SmartLoader L, for DSLR cameras. With lens support divider. Inside dimensions (WxHxD): 17.5 x 13 x 10 cm (6.9 x 5.1 x 3.9 in.).

8818 „EasyLoader“ Camera Bag

For digital and conventional SLRs.

With accessory pockets inside the outer lid and on both sides. Two tops, which can be connected via a Velcro closure. Spacious front pocket with organizer trays and zipper.

This camera bag allows quick access, as the top opens away from the body and stays open in a fixed position.

With carrying handle, detachable, adjustable and padded shoulder strap and belt loop.

Inside dimensions: 15.5 x 15 x 10 cm
(6.1 x 5.9 x 3.9 in.)





6066-71 „Tiltall“ Tripod

Sturdy camera tripod. Tripod legs and center column made from aircraft aluminium and carbon fiber respectively. Four-section tripod legs with anti-twist protection and twist locks for fast and easy operation. Spread angle of legs can be individually adjusted and locked in three positions, covered ratchet tothing with release button. 180 degrees reversible legs for reduced pack size. Rubber feet with retractable metal spikes made from stainless steel. Extendable center column with anti-twist device, twist lock and spring loaded hook. Reversible center column for macro shots. Center column can also be removed for close-to-ground level-setting. 1/4" - 3/8" interchangeable thread. All tripod legs have leg warmers made of foam layers covering the top section. One tripod leg is detachable and can be converted to a monopod by adding the removable center column.

Comes with a padded carrying case with adjustable shoulder strap and carry handle.

Code no.	6066	6067	6068
Type	TE-224	TE-254	TE-284
Material	Aluminium	Aluminium	Aluminium
Tube ø, max. (mm/in.)	22 / 0.9	25.5 / 1.0	29 / 1.1
Max. height (cm/in.)	140 / 55.1	147 / 57.9	162 / 63.8
Min. height (cm/in.)	14 / 5.5	14 / 5.5	15 / 5.9
Folded length (cm/in.)	40 / 15.7	43 / 16.9	47 / 18.5
Monopod height (cm/in.)	68-145 / 26.8-57.1	71-152 / 28.0-59.8	78-169 / 30.7-66.5
Weight (kg/lbs.)	1.1/2.4	1.4 / 3.1	1.8 / 4.0
Max. load (kg/lbs.)	8 / 17.6	8 / 17.6	12 / 26.4
Recommended ball head	BH-10 (6001)	BH-20 (6002)	BH-30 (6003)



Code no.	6069	6070	6071
Type	TC-224	TC-254	TC-284
Material	Carbon	Carbon	Carbon
Tube ø, max. (mm/in.)	22 / 0.9	25.5 / 1.0	29 / 1.1
Max. height (cm/in.)	140 / 55.1	147 / 57.9	162 / 63.8
Min. height (cm/in.)	14 / 5.5	14 / 5.5	15 / 5.9
Folded length (cm/in.)	40 / 15.7	43 / 16.9	47 / 18.5
Monopod height (cm/in.)	68-145 / 26.8-57.1	71-152/28.0-59.8	78-169 / 30.7-66.5
Weight (kg/lbs.)	0.9 / 2.0	1.1 / 2.4	1.4 / 3.1
Max. load (kg/lbs.)	8 / 17.6	8 / 17.6	12 / 26.4
Recommended ball head	BH-10 (6001)	BH-20 (6002)	BH-30 (6003)



6060-61 „Tiltall“ Monopod

Compact and sturdy monopod made from aircraft aluminium (6060) or eight-layer carbon fiber (6061) respectively. Quick set-up by simultaneous opening of all three twist locks. Four sections with anti-twist protection, detachable rubber foot on stainless steel spike, foam rubber leg warmer protects against cold, wrist strap. Carry bag included.

Max. height: 162 cm (63.8 in.)
 Pack size / min. height: 51 cm (20.1 in.)
 Exchangeable threads: B 1/4 / B 3/8

6060: MP 284, max. load: 11 kg (24.2 lbs.)
 Weight: 490 g (1.1 lbs.)

6061: MP 284C, max. load: 12 kg (26.4 lbs.)
 Weight: 380 g (0.8 lbs.)





6001-03 „Tiltall“ Ball Head

Solid ball head for viewfinder cameras, CSCs and DSLRs. Quick release system with dovetail clamping and blocking screw. Slide-off protection. Quick release plate with non-slip surface, 1/4" D-ring screw with coin slot. Adjustable friction. Locking knob with inset tensioning dial for setting the "released" tension. 360 degree panning socket with blocking screw and graduated scale. All locking knobs have rubber coated gripping surface and are secured against unintentional removal.

Two spirit levels. 3/8" tripod bush.

Specifications:

Code no.	6001	6002	6003
Type	BH-10	BH-20	BH-30
Ball ø (mm/in.)	30/1.2	36/1.4	44/1.7
Socket ø (mm/in.)	45/1.8	51/2.0	60/2.4
Height (mm/in.)	92/3.6	98/3.9	107/4.2
Weight (g/lbs.)	360/0.8	440/1.0	570/1.3
Max. load (kg/lbs.)	8/17.6	10/22.0	12/26.4



6004-07 Quick Release Plate for „Tiltall“ Ball Heads

With slip-off protection and 1/4" camera screw, width 39 mm (1.5 in.), height 10 mm (0.4 in.).

6004: length 40 mm (1.6 in.), aligned for 6001

6005: length 50 mm (2 in.), aligned for 6002

6006: length 60 mm (2.4 in.), aligned for 6003

6007: length 100 mm (3.9 in.), with additional camera screw 1/4" for mounting a lens with a tripod collar ring and with 3/8" exchangeable camera screw.

Any quick release plate is suitable for all „Tiltall“ ball heads (6001-03).

6011 Professional Ball-and-Socket Head

Professional ball-and-socket head. Lever screw for clamping the ball. Adjustable friction brake for presetting of friction. Rotating panorama base with fluid system, fixing screw and scale in three-degree divisions from 0° to ± 180°. Interchangeable camera mounting thread 3/8" / 1/4". Tripod thread 3/8" with 1/4" thread adapter.

Weight: approx. 650 g (1 lbs. 4 oz.)
 Height: approx. 123 mm (4.8 in.)
 Base diameter: approx. 56 mm (2.2 in.)
 Loading capacity: 8 kg (17.6 lbs.) max.



6017 Ball-and-Socket Head

Medium-weight version. Lever screw for fixing the ball. Rotating panorama base with fluid system, fixing screw and scale in five-degree divisions from 0° to ± 180°. Camera mounting thread 1/4". Tripod thread 3/8" with 1/4" thread adapter.

Weight: approx. 300 g (10.6 oz.)
 Height: approx. 98 mm (3.9 in.)
 Base diameter: approx. 45 mm (1.8 in.)
 Loading capacity: 4 kg (8.8 lbs.) max.



6013/18 Ball-and-Socket Head

1/4" connecting thread with lock nut. Handy lever screw for clamping the ball. 3/8" tripod thread with 1/4" thread adapter.

	6013 Light-weight model	6018 Medium-weight model
Weight: approx.	45 g/1.6 oz.	110 g/3.9 oz.
Height: approx.	50 mm/2"	67 mm/2.6"
Socket-ø: approx.	24 mm/1"	30 mm/1.2"
Max. load: approx.	1 kg/2.2 lbs.	2 kg/4.4 lbs.



6020 Quick Release Connector

For quick mounting of camera on tripod. The upper part is mounted on the camera's tripod bush and stays there, the lower part is attached to the tripod. Release lever with additional safety lock, three spirit levels for precise positioning, 3/8" tripod thread with 1/4" thread adapter. Connector plate with 1/4" threaded pin and immersible anti-twist device. Made of aluminium die cast. Dimensions: approx. 82 x 17 x 55 mm (3.2 x 0.7 x 2.2 in.), weight: approx. 79 g (2.8 oz.)



6024 Quick Release Connector Plate

Suitable for Quick Release Connector 6020.



6019
Swivel Joint

For small lighting units, light-weight cameras etc.

Tilts continuously up to 90° and rotates up to 360°. Central locking screw. 1/4" connection thread. Mounts on the accessory shoe or a tripod. 1/4" tripod thread. Lock rings for secure hold. Height: approx. 42 mm (1.7 in.)



5534
Focusing Stage

For exact camera positioning for close-up, macro photography and copying work. Two positioning scales are perpendicular to one another. Setting range 95 mm (3.7 in.) each. Prismatic precision guide-ways with micro adjustment by helical gear toothed lath complete with lock screws and dials calibrated in millimeters. Mounting plate with rubber pad. 1/4" camera mounting screw, 1/4" connecting thread.



6029/32
Binocular Mount

For mounting binoculars on tripods. 1/4" tripod socket.

6029: Attaches via 1/4" mounting thread.

6032: Attachment at center focusing. Span range from 12 mm (0.5 in.) up to 20 mm (0.8 in.).



3273
Accessory Bracket

Light metal bracket for mounting two accessories with tripod thread on a tripod, hand grip or swivel joint. Two relocatable 1/4" tripod screws with soft washers. Center placed 1/4" tripod bush. Length: approx. 15.5 cm (6.1 in.). Width: approx. 2.5 cm (1.0 in.).



6401
Assorted Screw and Thread Adapters

For mounting lights and other accessories. Comprises: two shoe mounts, four lock nuts and one knurled nut.

For detailed description see page 62.



6400
Assorted Screw and Thread Adapters

Contents:

- 3 mounting thread adapters 1/4" - 3/8"
- 3 camera-case screws 1/4" - 3/8"
- 3 camera-case screws 1/4" - 1/4"
- 2 bracket screws 1/4" - 3/8"
- 8 thread adapters 3/8" - 1/4"

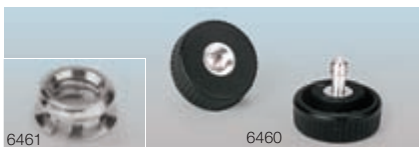

6460
Bracket Screws



Aluminium thread stem, extruded plastic body. \varnothing 30 mm (1.2 in.). B 1/4", A 3/8". Pack of two.

6461

6460

6461
Thread Adapters



Made of nickel-plated brass. Outer thread: 3/8", inner thread: 1/4". Pack of 10.

6045
DSLR Table Top Tripod

With three-section telescopic legs and extendable center column. 3-way pan head with tiltable camera platform for portrait and landscape shots. Built-in spirit level for exact alignment. Center column with suction cup for additional grounding on even and flat surfaces in lowest position. 1/4" tripod thread. Supplied incl. carrying pouch.

Max. load: 2 kg (4.4 lbs.)
Height: 18 to 30 cm (7.1-11.8 in.)
Folded length: 21 cm (8.3 in.)



6043-44
Multi-Level Table Tripod

Compact table tripod for digital compacts. Three-section telescopic feet. 1/4" mounting thread.

6043: Ball head with locking screw. Height continuously adjustable from 8.5 to 26 cm (from 3.3 to 10.2 in.). Length (folded): approx. 165 mm (6.5 in.), weight: approx. 100 g (3.5 oz.).

6044: With pan and tilt head and pan bar. Height continuously adjustable from 8 to 27 cm (from 3.1 to 10.6 in.). Length (folded): approx. 155 mm (6.1 in.), weight: approx. 185 g (6.5 oz.).



6049
Table Tripod



Mini-tripod for compacts, microphones etc. Flexible legs for leveled standing on uneven surfaces. Pocket clip. Rubber feet. 1/4" thread.

Height (positioned): approx. 12 cm (4.7 in.)
Weight: approx. 50 g (1.8 oz.)



5004
Pocket Tripod

Clamp-on and table-top tripod with ball-and-socket head and 1/4" connecting thread. Screw-on clamp with 35 mm (1.4 in.) max. span. Can be used as clamp-on stand after unscrewing legs, which may be stored in the stand's centre tube.

Height: approx. 125 mm (4.9 in.)
Weight: approx. 150 g (5.3 oz.)





6039 „Quik Pod DSLR Action“ Handheld Tripod & Monopod

Extendable hand-held tripod and monopod, suitable for using cameras, camcorders and smartphones at sports, action and outdoor activities.

Allows for taking photos of oneself in front of a favourite background and for shooting from above, from below and around the corner. Also suitable for underwater use (complies with ASTM B117 / ISO 9227 saltwater standard).

Tilt head with quick release adapter. Quick release plate with 1/4" connecting thread, can be exchanged with adapter plate for GOPRO® action cameras. A mirror surface below the tilt head is useful for frame control.

Telescopic slide-out made from black anodized aluminium, with anti-twist protection and quick release clamps. Handle with anti-slip coating.

Completely extended and with mounted end cap the "Quik Pod DSLR Action" becomes a monopod.

Length: min. 47 cm (18.5 in.)
max. 135 cm (53.1 in.)

Weight: approx. 295 g (0.65 lbs.)

Max. load: 1.5 kg / 3.3 lbs. (hand-held)
3.5 kg / 7.7 lbs. (monopod)

Includes adapter plate for GOPRO® cameras, rubberized monopod end cap, water-resistant wrist strap, pocket clip, bumper attachment, snap hook, key ring, tightening tool and carrying bag.



6046 „Quik Pod pro+“ Handheld Tripod

Extendable hand-held tripod with telescopic slide-out cameras and camcorders.

Allows for taking photos of oneself in front of a favorite background and for shooting from above, from below or around the corner. Can also be used underwater.

Ball head with locking screw. Camera platform with “1/4” tripod thread.

Mirror surface below the ball head is useful for framing.

Can easily be extended or folded.

Length (extended): approx. 46 cm (18.1 in.)
(folded): approx. 19 cm (7.5 in.)

Load capacity: max. 450 g (16 oz.)

Weight: approx. 100 g (3.5 oz.)

Includes belt clip, snap-hook, protective cover, wrist strap and tripod feet to convert Quik Pod pro+ into a table tripod.





6378
„Action Level Cross“
Digital Level

Cross indicator with 13 LEDs for simultaneous two-dimensional indication. Additional 7 LED side level indicator. Provides level check for camera in landscape or portrait position using LEDs with different colors. LED brightness and tilting sensitivity can be adjusted. Customized zero point setting. Automatic power cut-off. Can be mounted in the camera's accessory shoe (not on Sony/Minolta) or by means of a magnetic support plate included. Connection and outlet for a second unit for remote control and display if camera is in an awkward position.

Diameter: approx. 32 mm (1.3 in.)
Height: approx. 16 mm (0.6 in.)
Weight: approx. 6 g (0.21 oz.)
Max. sensitivity: $\pm 0.2^\circ$
Operating time: approx. 20 up to 30 hours

Scope of supply: Action Level Cross, 3 V battery (CR 2023), magnetic base, connecting cable for second unit, strap, carrying pouch.



6383
"Action Level Sound"
Digital Spirit Level

Can be used in portrait and landscape formats. Levelling is indicated by LEDs of different colors and/or varying beep sounds. Brightness, sensitivity and signalling can be adjusted. Fits in standard hot shoe (not suitable for Sony/Minolta cameras). Supplied with additional magnetic support plate.

Extremely compact design. Does on most cameras not interfere with the camera flash when it pops out.

Dimensions: 32 x 25 x 17 mm (1.3 x 1 x 0.7 in.)
Weight: 5 g (0.18 oz.)
Max. sensitivity: $\pm 0.2^\circ$
Operating time: approx. 20 to 30 hours

Scope of supply: Action Level Sound, four 3 V batteries (CR 1220) – two of them spare batteries, magnetic support plate, strap.



**6387
Duplex Spirit Level**

With twin levels and mounting feet for landscape and portrait position. Transparent housing.

Dimensions: approx. 18 x 18 x 33 mm
(0.7 x 0.7 x 1.3 in.)



**6385
Spirit Level**

One level each for vertical and horizontal shooting position. With mounting shoe and 1/4" tripod bush.

Dimensions: approx. 20 x 25 x 35 mm
(.8 x 1 x 1.4 in.)

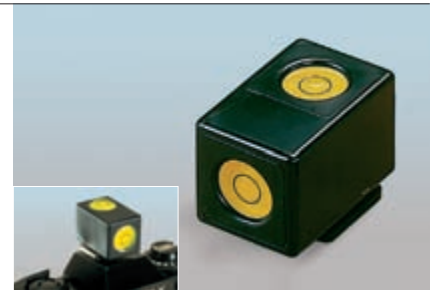

**6380
Duplex Screw-in Spirit Level**

With two levels for horizontal alignment. 1/4" threaded pin screws in camera's tripod thread. 1/4" threaded hole for mounting on tripods, brackets, holding arms etc.

The accidental position of the two levels to the camera body due to the screw-in thread can be adjusted by replugging the threaded bolt.

Diameter: approx. 4 cm (1.6 in.)
Height: approx. 12 mm (0.5 in.)



**6386
Spirit Level**

Circular bubble, self-adhesive. For permanent attachment to cameras, tripods etc. Can also be screwed on.

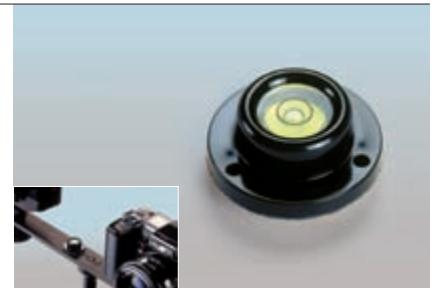
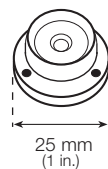



6126-27 „TwinLink T2Di“ Radio and IR Flash Trigger

Set with transmitter and receiver for wireless triggering of studio and camera flashes. Simultaneous triggering via 2.4 GHz radio frequency and infrared signals using eight high performance LEDs. 32 user selectable channels. Transmitter and receiver with external aerials and LCD panels that can be illuminated. Automatic power cut-down after pre-determined time. Transmitter can be attached using the camera's hot shoe or with an adhesive accessory shoe mount in a convenient location.

Receiver with tripod thread and mounting magnets for attachment on metal surfaces or via an adhesive metal plate supplied with the set. Receiver has a hot shoe and trigger cable terminals for PC and 2.5 mm jack-plug. Battery or mains operation (mains adapter code no. 6142 not included).

Max. working range: indoor: approx. 50 m (150 ft.), outdoor: approx. 200 m (600 ft.)

Max. sync speed: 1/250 sec. (depending on camera and flash)

Dimensions: transmitter: 40 x 68 x 35 mm (1.6 x 2.7 x 1.4 in.), receiver: 50 x 80 x 25 mm (1.9 x 3.1 x 1 in.)

Weight: transmitter: 35 g, receiver: 53 g



Scope of supply:

- 6126:** „TwinLink T2Di“: transmitter and receiver, PC cord, trigger cable 2.5-3.5, 3.5-6.3 adapter plug, adhesive accessory shoe base, adhesive metal plate, 3 AAA batteries for receiver, 2 CR2032 batteries for transmitter, receiver fixture clip.
- 6127:** „TwinLink T2RxDi“: receiver, extends "TwinLink T2Di", trigger cable 2.5-3.5, 3.5-6.3 adapter plug, adhesive metal plate, 3 AAA batteries, fixture clip.

Important notes

Transmitter T2Tx and receiver T2RxDi from the 6126 (T2Di) and 6127 sets are not compatible with the previous versions (transmitter T2Tx and receiver T2RxDi supplied under code no. 6140 (T2D) and 6141). To find out about correct type designation, please check the label inside the battery compartment.

6142 **Mains Adapter**

For use with the "TwinLink T2RxDi" receiver of the "TwinLink T2Di" flash trigger.





1405
PC-PC Coiled Cord

Spiral cord with male PC plug on both sides to connect flashguns with PC port e.g. for Nikon SB-24, -25, -26, -28, -28 Dx, -80 Dx, -800, -900, -910 and Canon 580 EX II, 600 EX, 600 EX-RT.

Length (extended): 65 cm (25.6 in.)



1407
PC-PC Flash Cable

Flash cable with male PC plug on both sides to connect flashguns with PC outlet to the camera, e.g. Nikon SB-24, -25, -26, -28, -28 Dx, -80 Dx, -800, -900, -910 and Canon 580 EX II, 600 EX, 600 EX-RT.

Length: 5 m (16.4 ft.)



1408-09
Flash Cable

Professional flash connecting cable with spiral coil for pull relief. Signal red, length approx. 10 m (33 ft.).

1408: PC plug and jack plug \varnothing 3.5 mm

1409: PC plug and jack plug \varnothing 6.35 mm



1420-26
Extension Cord

For connecting flash equipment. With right-angle plug and socket (PC).

1420: 0.5 m (1 ft. 8 in.)

1423: 2.0 m (6 ft. 10 in.)

1424: 3.0 m (9 ft. 10 in.)

1425: 5.0 m (16 ft. 5 in.)

1426: 10.0 m (32 ft. 10 in.)

**1512
Clamp**

For simple attachment of flashguns and lightweight lighting units. Removable accessory shoe on ball joint. Tilttable to all sides in infinite steps, lockable in any position. Additional connecting thread 1/4". With reflector umbrella holder \varnothing 9.2 mm. Clamp is impact-resistant plastic with non-slip rubber studs.

Clamp span: max. 40 mm (1.6 in.)
Height: approx. 90 mm (3.5 in.)



**1322
Triple PC Flash Outlet**

For simultaneous use of up to three flash units with standard PC plugs.

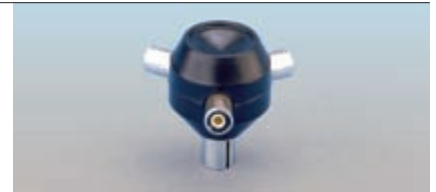

**1311
Flash Socket**

Nipple to Standard DIN 19003 (PC) for connecting flash equipment.

Package of 10 pieces.



**1313
Flash Socket Adapter**

For connecting flash equipment with standard PC plugs to Leica cameras of the M1 - M3 series.



**1326
Right Angle Male Plug**

With plug to DIN 19003 (PC) for self-fitting to flash cables. With soldering tags.





1201
Bounce Flash Shoe

For indirect flashing. With ball-and-socket joint for stepless movement in all directions. Accessory shoe detachable. 1/4" mounting thread with lock nut. Reflector umbrella holder 9.2 mm diameter. For fastening to accessory shoe or stands. Stand thread 1/4" with removed slot-on foot 3/8". Accessory foot with fixing screw.

Height: approx. 95 mm (3.7 in.)



1503-04
Remote Flash Trigger

For wireless lag-free firing of a second flash unit. Range up to 20 m (65.6 ft.) depending on the guide number of the flash unit and room brightness. 1/4" tripod bush. Features an additional PC flash terminal to connect another flash unit.

1503: for flash units with standard ISO foot and hot flash contact

1504: for flash units with 4-pin Sony/Minolta foot



1200
Bounce Flash Shoe

For indirect flash illumination. Steplessly adjustable. With 1/4" tripod bush. Fits into accessory shoe or tripods.

Height: approx. 45 mm (1.8 in.)



1216
Mounting Shoe

For mounting flash units on tripods and ball joints. With 1/4" tripod thread.

Height: approx. 12 mm (0.5 in.)
Diameter: approx. 30 mm (1.2 in.)



1211
Accessory Shoe

For mounting flash guns with 1/4" thread. With threaded pin (1/4") and lock nut.

Height: 25 mm (1 in.)

1215
Sony/Minolta Accessory
Shoe Adapter

Enables mechanical connection of accessories with standard ISO foot on cameras with Sony-/Minolta flash shoe. Flexible tongues on both sides provide for tight fit. No electrical contacts for flash units.



1300
Flash Shoe Adapter



For cameras with hot flash shoe and flash equipment without hot flash shoe. With synchro flash socket.

Height: 16 mm (0.6 in.)



1301
Flash Shoe Adapter

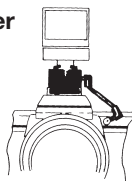

For cameras without hot flash contact and flash equipment with hot flash contact. With approx. 30 cm (11.8 in.) detachable synchro cable, shoe mount and 1/4" tripod bush. Also designed for attaching flash equipment with hot flash contact on tripods.

Height: 16 mm (0.6 in.)



1303
Flash Adapter

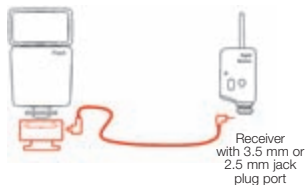

For connecting flash guns to receivers of RC remote releases, e.g. Kaiser TwinLink, Pocket Wizard, Skyport, etc. Set consisting of hot shoe adapter with tripod thread and removable synch cord with 3.5 mm jack plug and synch cord with 2.5 mm jack plug.

Length of cables: approx. 30 cm (11.8 in.) respectively.



1304
Flash Adapter

For firing flash units with standard ISO foot and center contact mounted on a Sony/Minolta DSLR camera with proprietary 4-pin foot.

Features an additional PC flash terminal to connect another flash unit.



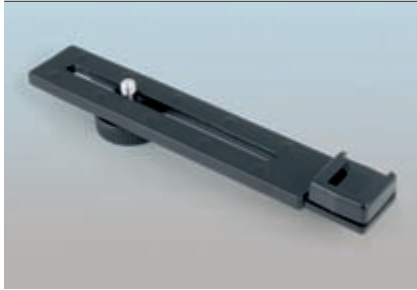

**1000
Flash Bracket**

Light metal bracket with resilient contact surface. Mounting screw with 1/4" thread and tripod bush.

Length: 16.5 cm (6.5 in.),
Width: 2.8 cm (1.1 in.)

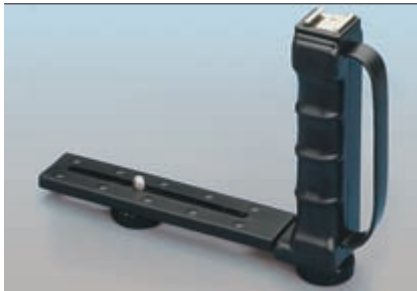

**1100
Angle Bracket**

Collapsible. Grip with hand strap. Hinged camera bracket of light metal with resilient contact surface. Mounting screw with 1/4" thread and tripod bush.

Length: approx. 14 cm (5.5 in.)
Width: approx. 2.8 cm (1.1 in.)
Height of grip: approx. 13.5 cm (5.3 in.)



**1107
Angle Bracket**

Collapsible. Hinged camera bracket of light metal with resilient contact surface. Slide-in foot for flash units or video lights. Widened three-point rest on bottom side. Camera with mounted bracket stands firmly on flat surfaces. Mounting screw with 1/4" thread and tripod bush.

Length: approx. 16.2 cm (6.4 in.)
Width: approx. 6.5 cm (2.6 in.)
Height of grip: approx. 15.1 cm (5.9 in.)



**1108
Universal Accessory Bracket**

Two-part angle bracket for mounting accessories such as flashguns, lights, microphones, GPS logger etc. on cameras and camcorders. The bracket can be aligned to the camera in different ways.

Mounting screw with 1/4" thread. Attaches to the tripod mount of the camera or camcorder.

Bracket has a removable securing pin as an anti-twist lock and for precise positioning.

6601-02
„ProDisk“ Calibration Tool

Combination of white balance filter, grey card and colour reference card in a slim, foldable plastic housing. Colour card and grey card located in lower resp. upper cover. Translucent white balance filter with special surface pattern.

Includes neck strap.

6601: ProDisk mini

White balance filter for lenses up to 6 cm (2.4 in.) diameter
Dimensions (folded down): 103 x 73 x 10 mm (4.1 x 2.9 x 0.4 in.)
Weight: 75 g (2.6 oz.)

6602: ProDisk II

White balance filter for lenses up to 9 cm (3.5 in.) diameter
Dimensions (folded down): 145 x 101 x 11 mm (5.7 x 4.0 x 0.5 in.)
Weight: 135 g (4.8 oz.)



6605-11
„Vivicap“ White Balance Filter

Snap-on filter with specially designed prism structured surface for white-balancing of digital cameras and camcorders. Easy to use clamping mechanism provides for quick installation and removal. Serves also as a lens cap and can also be attached when a lens hood is used.

6605: ø 52 mm

6606: ø 55 mm

6607: ø 58 mm

6608: ø 62 mm

6609: ø 67 mm

6610: ø 72 mm

6611: ø 77 mm

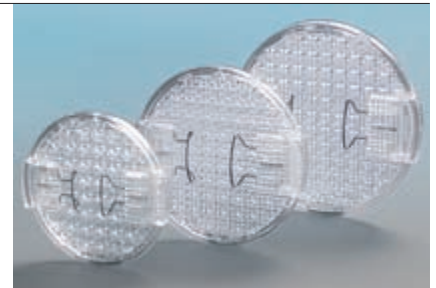



6494
Memory Card Box

Flat metal box for secure storage of three SD/Multimedia / xD / Memory Stick cards.

Dimensions: approx. 9.5 x 6 x 0.5 cm
(3.7 x 2.4 x 0.2 in.)



6495-96
Memory Card Box

Slim plastic box for secure storage of two SD or CompactFlash memory cards. Shaped rubber insert. Protects against shock, dirt and moisture.

Reliable snap lock.

Dimensions: approx. 9.3 x 6 x 1.3 cm
(3.7 x 2.4 x 0.5 in.)

6495: grey

6496: neon yellow



6497
Battery Box

For 4 AA or AAA batteries. 2 pieces. Stackable. Color: grey and blue.

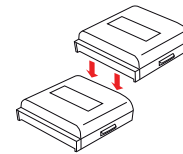

6389-90
Changing Bag

For working with light-sensitive material where no darkroom is available. Made of special black light-proof fabric with rubber lining. Infrared light-proof. With two hand holes and light-proof zipper.

6389: approx. 68 x 76 cm (26.8 x 29.9 in.)

6390: approx. 40 x 43 cm (15.7 x 16.9 in.)

4129
Film Loader

For loading bulk 35 mm film into cartridges in daylight. For bulk film material up to 30 m (98 ft.). With frame counter and remaining-film meter.

Dimensions: approx. 130 x 110 x 80 mm
(5.1 x 4.3 x 3.1 in.)



4127
Film Cartridges

For 35 mm film. For self-loading with bulk film material. Plastic type, 5 pcs.



4125
Film Cartridge Opener

For opening 35 mm film cartridges.

Dimensions: approx. 140 x 40 x 40 mm
(5.5 x 1.6 x 1.6 in.)

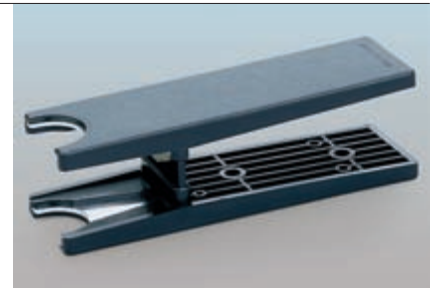

4132
Film Leader Retriever

For extracting 35 mm film leader from cartridges into which the film has been wound. Plastic casing with one fixed and one sliding tongue. Simple use.





96653



96654



96657

96653 Video-Transfer

For copying cinefilms (8 mm, 16 mm) and slides on to video. Backprojection screen with fine-grained 100 x 75 mm (3.9 x 3.0 in.) viewing screen. Built-in reversing mirror for true-sided image. Integrated close-up lens with 55 mm (2.2 in.) diameter. Strong table base with adjustable feet and spirit level on base. Stepless height adjustment. Dimensions (BxHxD) approx. 230 x 190 (230) x 142 mm (9.1 x 7.5 (9.1) x 5.6 in.)

96655 Video Transfer Set

Consisting of the video transfer unit 96653, table stand 96654 for the camcorder, filter adapter 96656 for projection lenses from 25 to 62 mm (1 to 2.4 in.) diameter and close-up lens 2 (14249).

96654 Table Stand

Strong table stand with 1/4" mounting thread. For stable positioning of camcorders, particularly when combined with the video transfer unit 96653. Table base with adjustable feet and spirit level in base. Stepless height adjustment from 96 to 136 mm (3.8 x 5.4 in.) Dimensions (BxHxD) approx. 182 x 101 (141) x 117 mm (7.2 x 4 (5.6) x 4.6 in.)

96656 Filter Adapter

For fastening filters and close-up lenses with 49 mm diameter to projection lenses. The filter adapter is simply pressed on. It automatically adapts to lens diameters from 25 mm to 62 mm (1 to 2.4 in.). Only suitable for lenses that project out of the projector casing when in use.

96657 Filter Adapter Set

Consisting of 96656 filter adapter and 14249 close-up lens. Used in conjunction with the video transfer unit (e.g. Art. No. 96653) to copy slides onto video when the slide projector does not focus down to short distances and does not have a filter mount for close-up lenses.



Filters

Important Auxiliaries: Filters

Basically optical filters work in digital photography the same way as they do with film. Used properly, they favorably affect the light hitting the film or the sensor to enhance the image. Digital image processing can not always easily duplicate the filter effect.

The filter effects can be seen as a way of image processing prior to taking a picture, and this works not only easily and quickly, but will sometimes make impossible shots possible.



Neutral **UV filters** absorb the very short ultra-violet wavelengths, which - especially in the mountains, in high altitudes and over long stretches of water - produce a misty background caused by atmospheric stray light. As a result clear views are brighter and sharper.



Skylight filters are slightly reddish colored UV filters and give pictures a warm touch. Otherwise they have the same characteristics as neutral UV filters. They are especially useful for analogue photography.

UV/IR blocking filters do not only block UV, but additionally IR radiation. This is of importance with digital cameras, because sensors are sensitive to IR radiation. Normally digital cameras have an IR blocking filter integrated in the protective glass screen in front of the sensor, but with intensive IR radiation its blocking effect is not sufficient and color distortion and loss of contrast might occur.



Polarizing filters can enhance a blue sky, suppress unwanted glare and improve color saturation in general. In addition reflections on glass, water, shiny surfaces, e.g. on cars or on sunlit leaves, are eliminated. Polarizing filters can also reduce very high contrasts which can be an advantage with digital cameras with a low dynamic range.

Linear and **circular polarizing filters** have the same effects, their difference lies in camera compatibility. Cameras with split-beam metering or autofocus will require a circular polarizing filter. If you are not sure what to use, a circular polarizer will keep you on the safe side.





A **Neutral Density (ND)** or **gray filter** reduces the amount of light entering the camera lens without affecting the color rendition. This helps to obtain a slower shutter speed to enhance blurring of movement for example, or will result in a larger lens aperture thus enabling better separation of foreground and background. With digital cameras you may also use a lower ISO setting to achieve this, but if that is not possible, a neutral density filter will be the only solution.

With Vario-ND filters light incidence can be reduced continuously.



Close-up lenses reduce the minimum focusing distance of any lens. With +1, +2, +3 and +4 diopters and a standard lens you will get focusing distances less than 100, 50, 33 or 25 cm (40, 20, 13 or 10 in.). Two or more close-up lenses can be combined.

When shooting black-and white, colors are converted to different gray tones. Filters can help to enhance particular attributes or to achieve special effects. These filters are

intended to used analogue black-and-white photography, but might possibly also used with digital photography.

Yellow filters are also advantageous for landscape photography, for example white clouds stand out much better against a blue sky. Once again green will contrast better. Yellow filters will also tone down skin blemishes when shooting portraits.



Orange filters provide for a lighter rendition of yellow and red, whereas blue is much darker. Landscape and architectural photos are richer in contrast and plasticity.



Red filters are perfect for generating dramatic moods in landscape photography as a blue sky becomes very dark and white clouds shine brightly. An equally intense contrast can be achieved in architectural photography when shooting a bright facade in front of a blue sky.





Kaiser Filters

Common features: Light alloy mount with front thread. Supplied with storage box (except Vario ND Filter).

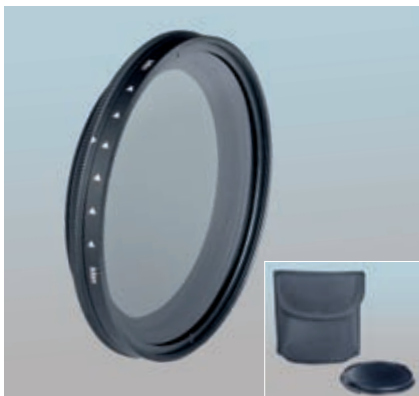

UV-Filters

10137-82: Slime line metal mount, blackened at the lens edge to prevent glare effects. Double-sided coating.

10237-82: Slime line metal mount, blackened at the lens edge to prevent glare effects. Six layer multi-coating on both sides, water repellent lotus effect.

Circular Polarizer

15737-82: Slime line metal mount, blackened at the lens edge to prevent glare effects. Six layer multi-coating on both sides.

Neutral Density (ND) Filters

15237-82: 4x/0.6, filter factor 4

15337-82: 8x/0.9, filter factor 8

Vario ND Filter

2x-400x, filter factor 2 to 400, supplied with extra lens cap and pouch.

15437: \varnothing 37 mm, with lens cap \varnothing 46 mm

15449: \varnothing 49 mm, with lens cap \varnothing 58 mm

15458: \varnothing 58 mm, with lens cap \varnothing 67 mm

15467: \varnothing 67 mm, with lens cap \varnothing 77 mm

15477: \varnothing 77 mm, with lens cap \varnothing 86 mm

Close-up Lenses

14137-82: Close-up lens 1, +1 dioptr

14237-82: Close-up lens 2, +2 dioptr

14337-82: Close-up lens 3, +3 dioptr

14437-82: Close-up lens 4, +4 dioptr

	UV Filter	UV Filter MC	Circular Polarizer MC	4x/0.6 ND Filter	8x/0.9 ND Filter	2x-400x Vario ND Filter	Close-up Lens 1	Close-up Lens 2	Close-up Lens 3	Close-up Lens 4
	Code #	Code #	Code #	Code #	Code #	Code #	Code #	Code #	Code #	Code #
ø 37 mm	10137	10237	15737	15237	15337	15437	14137	14237	14337	14437
ø 40.5 mm	10140	10240	15740	15240	15340	-	14140	14240	14340	14440
ø 43 mm	10143	10243	15743	15243	15343	-	14143	14243	14343	14443
ø 46 mm	10146	10246	15746	15246	15346	-	14146	14246	14346	14446
ø 49 mm	10149	10249	15749	15249	15349	15449	14149	14249	14349	14449
ø 52 mm	10152	10252	15752	15252	15352	-	14152	14252	14352	14452
ø 55 mm	10155	10255	15755	15255	15355	-	14155	14255	14355	14455
ø 58 mm	10158	10258	15758	15258	15358	15458	14158	14258	14358	14458
ø 62 mm	10162	10262	15762	15262	15362	-	14162	14262	14362	14462
ø 67 mm	10167	10267	15767	15267	15367	15467	14167	14267	14367	14467
ø 72 mm	10172	10272	15772	15272	15372	-	14172	14272	14372	14472
ø 77 mm	10177	10277	15777	15277	15377	15477	14177	14277	14377	14477
ø 82 mm	10182	10282	15782	15282	15382	-	14182	14282	14382	14482



Rodenstock Filters

Common features: Wide angle suitable slim line metal mount with front thread. High-class optical glass with supreme surface quality, blackened at the lens edge to prevent glare effects. Highly scratch resistant. Supplied with storage box.

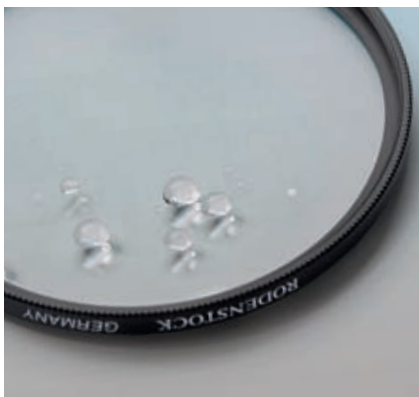

UV Filters

17734-82: Digital pro UV MC, multi-coated, highest transmission from 400 nm, light alley mount.

17937-95: HR Digital UV super MC, multi-coated, highest transmission from 400 nm, extremely scratch resistant, water repellent lotus effect, brass mount.

Circular Polarizers

17849-82: Digital pro CPL MC, multi-coated, absolutely colour neutral, light alley mount.

18049-95: HR Digital CPL super MC, multi-coated, absolutely colour neutral, extremely scratch resistant, water repellent lotus effect, brass mount.

Neutral Density (ND) Filters

Multi-coated, colour neutral, brass mount.

18249-82: HR Digital ND 0.3/2x MC, filter factor 2

18449-82: HR Digital ND 0.6/4x MC, filter factor 4

18849-82: HR Digital ND 0.9/8x MC, filter factor 8

Variable ND Filter

18949-82: Digital Vario ND 2 – 400 MC, multi-coated, colour neutral, light alley mount.

UV/IR Filter

19037-82: HR Digital UV/IR, steep edge interference filter, colour neutral, brass mount.

Skylight Filter

16237-95: Skylight MC, multi-coated, brass mount.

Filters for Black & White Photography

Coated, brass mount.

16537-95: Medium yellow filter

15837-95: Dark yellow filter

16737-95: Orange filter

16837-95: Bright red filter

16037-95: Dark red filter

	"Digital pro UV MC" UV Filter		"HR Digital UV super MC" UV Filter		"Digital pro CPL MC" Circular Polarizer		"HR Digital CPL super MC" Circular Polarizer		"HR Digital ND 0.3/2x MC" ND Filter		"HR Digital ND 0.6/4x MC" ND Filter		"HR Digital ND 0.9/8x MC" ND Filter		"Digital Vario ND 2-400 MC" ND Filter		"HR Digital UV/IR" UV/IR Filter		"Skylight MC" Skylight Filter		Medium Yellow Filter (8 ¹⁾)		Dark Yellow Filter (8 ¹⁾)		Orange Filter (15 ¹⁾)		Bright Red Filter (22 ¹⁾)		Dark Red Filter (25 ¹⁾)	
	Code #	Code #	Code #	Code #	Code #	Code #	Code #	Code #	Code #	Code #	Code #	Code #	Code #	Code #	Code #	Code #	Code #	Code #	Code #	Code #	Code #	Code #	Code #	Code #	Code #	Code #	Code #	Code #	Code #	Code #
ø 34 mm	17734	-	-	-	-	-	-	-	-	-	-	-	-	-	-	-	-	-	-	-	-	-	-	-	-	-	-	-	-	-
ø 37 mm	17737	17937	-	-	-	-	-	-	-	-	19037	16237	16537	15837	16737	16837	16037													
ø 39 mm	-	17939	-	-	-	-	-	-	-	-	-	16239	16539	15839	16739	16839	16039													
ø 40.5 mm	17740	17940	-	-	-	-	-	-	-	-	19040	16240	16540	15840	16740	16840	16040													
ø 43 mm	17743	17943	-	-	-	-	-	-	-	-	19043	16243	16543	15843	16743	16843	16043													
ø 46 mm	17746	17946	-	-	-	-	-	-	-	-	19046	16246	16546	15846	16746	16846	16046													
ø 49 mm	17749	17949	17849	18049	18249	18449	18849	18949	19049	16249	16549	15849	16749	16849	16049															
ø 52 mm	17752	17952	17852	18052	18252	18452	18852	18952	19052	16252	16552	15852	16752	16852	16052															
ø 55 mm	17755	17955	17855	18055	18255	18455	18855	18955	19055	16255	16555	15855	16755	16855	16055															
ø 58 mm	17758	17958	17858	18058	18258	18458	18858	18958	19058	16258	16558	15858	16758	16858	16058															
ø 62 mm	17762	17962	17862	18062	18262	18462	18862	18962	19062	16262	16562	15862	16762	16862	16062															
ø 67 mm	17767	17967	17867	18067	18267	18467	18867	18967	19067	16267	16567	15867	16767	16867	16067															
ø 72 mm	17772	17972	17872	18072	18272	18472	18872	18972	19072	16272	16572	15872	16772	16872	16072															
ø 77 mm	17777	17977	17877	18077	18277	18477	18877	18977	19077	16277	16577	15877	16777	16877	16077															
ø 82 mm	17782	17982	17882	18082	18282	18482	18882	18982	19082	16282	16582	15882	16782	16882	16082															
ø 86 mm	-	17986	-	18086	-	-	-	-	-	-	16286	16586	15886	16786	16886	16086														
ø 95 mm	-	17995	-	18095	-	-	-	-	-	-	16295	16595	15895	16795	16895	16095														

¹⁾ corresponding Kodak filter designation



6542-99 Filter Adapter Ring

For mounting filter and front attachments to lenses with deviating mounting threads. Precision metal rings with dull black surface. (6585: silver surface).

Lens thread – Filter thread

6547: 27 - 37	6555: 52 - 49
6584: 28 - 37	6556: 52 - 55
6585: 30 - 37	6557: 52 - 58
6586: 30.5 - 37	6558: 52 - 62
6588: 34 - 37	6561: 55 - 52
6589: 37 - 43	6562: 55 - 58
6542: 37 - 46	6563: 55 - 62
6543: 37 - 49	6564: 55 - 67
6544: 37 - 52	6565: 58 - 52
6591: 39 - 43	6567: 58 - 55
6592: 40.5 - 43	6568: 58 - 62
6593: 40.5 - 46	6566: 58 - 67
6594: 40.5 - 49	6569: 62 - 58
6548: 40.5 - 52	6570: 62 - 67
6599: 41.5 - 46	6571: 62 - 72
6595: 43 - 46	6572: 62 - 77
6596: 43 - 49	6573: 67 - 58
6549: 43 - 52	6574: 67 - 72
6545: 46 - 49	6575: 67 - 77
6546: 46 - 52	6576: 72 - 58
6597: 46 - 55	6577: 72 - 77
6550: 49 - 52	6578: 77 - 58
6551: 49 - 55	6579: 77 - 82
6552: 49 - 58	





Cleaning & Care

Neat Appearance

A neat appearance is always positive and this applies also to technical devices like a camera, that very often accompanies its owner to various places. Reliable, proper functioning of photographic equipment is even more important. Especially the camera, (hopefully) being a reliable companion on holidays, at events or family celebrations is very often exposed to the effects of weather conditions, that can be the cause for breakdowns of camera functions or of inferior picture quality, which can result in our losing documents of some irretrievable occasions.

These are good reasons to give special attention to the „cleaning & care“ issue and to complement the camera equipment with some important accessories.

The camera is an optical device with „a visual function“ which is why it always needs to be „clear and clean“. Lenses and optical attachments, viewfinder eyepieces, displays and monitors should be free from dust, dirt, finger prints, water marks etc. Cloths, sprays, brushes and compressed air are the appropriate tools for the cleaning and care of your optical surfaces and these should be with you wherever you go.



6308-10
„Clear Gear“ Compressed Air

For touch-free dust removal from optical, fine mechanical and electronic equipment and components. With spray valve and capillary tube for inaccessible places.

6308: „Clear Gear“ compressed air can, 200 ml, propane/butane mixture.

6309: „Clear Gear“ compressed air can, 400 ml, non-inflammable fluorethane mixture, special high pressure version.

6310: „Clear Gear“ compressed air can, 400 ml, propane/butane mixture, special high pressure version.



6316
„Typhoon“ Blower Bellows

Large rubber bulb for strong blowing effect. Rugged front air nozzle, rear air duct valve. Easy to handle.

Cleaning brush included.

Length (without brush top): approx. 18.5 cm (7.3 in.)

Bellows diameter: approx. 6 cm (2.4 in.)

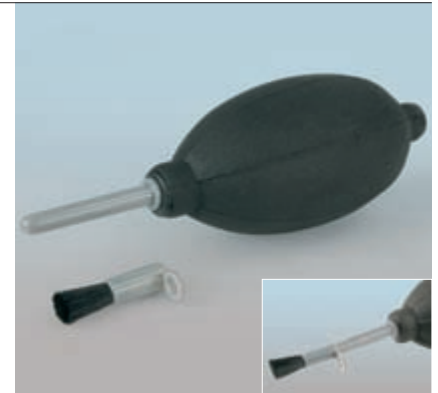

6305
„mini“ Blower Bellows

Compact rubber bellows. Fine short front air nozzle, rear air duct valve. Easy to handle.

Length: approx. 10.5 cm (4.1 in.)

Bellows diameter: approx. 5 cm (2 in.)





6314
Blower Brush

Flat brush with large rubber blower bulb.
Length: approx. 11 cm (4.3 in.)
Bellows diameter: approx. 4 cm (1.6 in.)

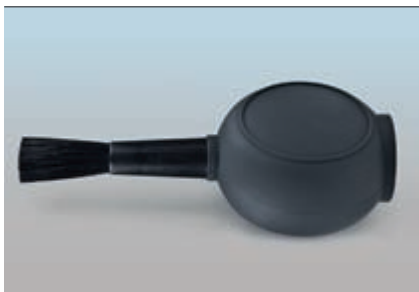

6311
Blower Brush

Round brush with silicone blower bulb.
Can be set upright.
Length: approx. 10 cm (3.9 in.)
Bellows diameter: approx. 5/3.3 cm (2/1.3 in.)



6301
Lens Brush

In plastic tube. With lipstick twist mechanism, not lubricated.
Length (extended): approx. 10.5 cm (4.1 in.)
Tube: approx. 8 cm (3.1 in.)



6695
Optical-Glass Cleaning Paper

Special paper, free from silicone, for cleaning optical glass.

Pack of 4 rolls of 40 sheets each.



36 rolls of
Optical-Glass Cleaning Paper

6328
Micro Fibre Cleaning Cloth



Assortment
of 25 x 6328

Completely fluff-free, grease-absorbing cloth for gentle, yet effective cleaning of optical lenses (glasses, lenses, magnifiers), but also suitable for CDs, records, photos, slides, TV/monitor screens, etc. Washable without loss of cleaning properties. Hemmed edges. In different colours.

Size: 20 x 20 cm (7.9 x 7.9 in.)

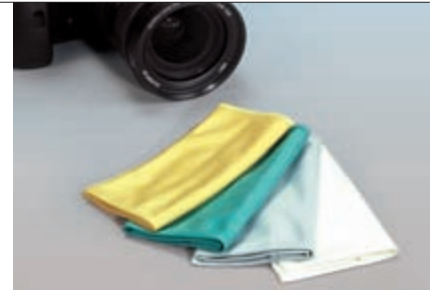

6330
Rodenstock Micro Fibre Cloth

Completely fluff-free, grease-absorbing cloth for gentle, yet effective cleaning of optical lenses (glasses, lenses, magnifiers), but also suitable for CDs, records, photos, slides, TV/monitor screens, etc. Takes up all moisture, oil and grime. Machine or hand washable without loss of cleaning properties. Colour: White, in a black pocket.

Size: 17.5 x 15 cm (6.9 x 5.9 in.)

Display holding 30 cloths.



6361
Antistatic Cloth

Lint-free, especially treated cloth.

Dimensions: approx. 24 x 30 cm (9.4 x 11.8 in.)



6363
Special Antistatic Cloth

High-grade lint-free cloth with chainstitched border for cleaning and antistatic treatment of films, glass, and lenses. Also suitable for phonograph records, plastic parts and plastic-coated surfaces.

Dimensions: approx. 24 x 30 cm (9.4 x 11.8 in.)



6364
Leather Cleaning Cloth

Genuine leather. For cleaning optical glass.
5 pcs.





6663
Cleaning Set

For wet cleaning of sensitive surfaces: lenses, LCD screens, glasses, binoculars etc. Cleaning pen with slanted square shaped felt tip, soaked with environment-friendly cleaning fluid without alcohol, silicone or ammoniac. Surface-gentle.

Comprises:

- Cleaning pen with safety cap
- Micro fibre cloth 14 x 18 cm (5.5 x 7.1 in.), for rubbing down and polishing



6662
Display and Optics Cleaning Kit

Includes „Display Cleaner“ pump spray and a micro fibre cleaning cloth. Alcoholic cleaning fluid in 25 ml (0.8 fl.oz.) pump spray dispenser for well directed application on the area to be cleaned and subsequent removal using the micro fibre cloth. Leaves no residues. Suitable for optical and plastic glass.



6697
Cleaning Set

Consisting of optical-glass cleaning fluid, optical-glass cleaning paper and blower brush.



6699
Cleaning Set

Consisting of lens cleaning paper, cleaning leather and blower brush. For cameras, lenses, binoculars, spectacles etc.

6362/65/67
Cotton Gloves

To prevent fingerprints on prints, negatives, optical glass, etc. 100 % cotton, washable at all temperatures.

6362: One pair, size XL

6365: One pair, size L (standard size)

6367: Three pairs, size L



6323
Contact Cleaner

For cleaning oxidized and dirty battery contacts and contact surfaces in electric devices. Handy pencil form with twist-out fibreglass tip.



6678
„Xerapol“ Plastic Polish

Polish paste for removing scratches from acrylic glasses, for example on shooting tables or light boxes. Also suitable for acrylic glass parts of cars, motorbikes, caravans, mobile homes, furniture etc. Not suitable for matt acrylic surfaces.

Tube with 50 g (1.8 oz.) of polish paste. Includes polishing cloth and special sand paper.



6679
Acrylic Glass Cleaner

Special cleaning spray for acrylic glass. Removes fingerprints, residues of grease, felt marker and other contaminations. Streak and smear free cleaning. With antistatic and water-repellent effect. Alcohol-free, non-flammable. Bio-degradable.

Pump spray bottle with 250 ml (8.5 fl.oz.).





Kinetronics SpeckGRABBER®

The SpeckGRABBER removes individual particles of dust and dirt from sensitive surfaces without damaging them or leaving any residues on them. It therefore has a tip with high adhesive strength, which is brought into contact with the particles.

This technique is used for removing particles of dirt from camera sensors (respectively their glass covers), SLR mirrors, lenses and oculars, as well as films, slides, the glass of picture frames or other sensitive surfaces.

The tip can be cleaned with cleaning solutions, water or soap solutions without this having any impact on its adhesive strength.

702 001: SpeckGRABBER (SG)

702 002: SpeckGRABBER Pro (SGP), with rubber-coated handle.

702 005: SpeckGRABBER Pro Kit (SGK), with SpeckGRABBER Pro handle, three tips, cleaning solution and Panther anti-static cloth in robust box.

702 004: SpeckGRABBER Pro Kit (SGL), handle with integrated mini lamp, battery, three tips, screwdriver inside handle, cleaning solution and Panther anti-static cloth in robust box.



**Kinetronics
„Tiger Cloth“ Antistatic Cloth**

Soft, lint-free micro fibre cloth with conductive fibres woven into the basic fabric for efficient discharge of static charges. The cloth is washable without losing its antistatic effect.

- 700 001:** ASC, 25 x 45 cm (9.8 x 17.7 in.)
- 707 030:** ASC-TC8, 20 x 20 cm (7.9 x 7.9 in.)
- 707 031:** ASC-TC5, 13 x 14.5 cm (5.1 x 5.7 in.)



**Kinetronics
„Panther Cloth“ Antistatic Cloth**

Antistatic cloth specially optimized for use with fluids and cleaning solutions. Antistatic effect through conductive weave components.

- 706 518:** PC-BP, 25 x 45 cm (9.8 x 17.7 in.)
- 706 510:** PC-MPC8, 20 x 20 cm (7.9 x 7.9 in.)
- 706 511:** PC-MPC5, 13 x 14.5 cm (5.1 x 5.7 in.)



**Kinetronics
Antistatic Gloves**

Made from soft micro fibre with conductive fibres woven into the basic fabric. Discharge static charges and prevent dust adducing electrostatic charges. Lint-free. Washable.

- 750 001:** ASG-S, size S
- 750 002:** ASG-M, size M
- 750 003:** ASG-L, size L



**Kinetronics
„Static Wisk® SW-010“
Antistatic Brush**

Antistatic cleaning brush for removing loose particles of dust from sensors of digital cameras, for removing dust from SLR mirrors, lenses etc. The combination of antistatic brush hairs and a conductive handle removes static charges. Brush head mounted in sliding sleeve to control the brush hardness via the length of the brush hairs. Supplied with neck strap.

- 700 010:** SW-010, 10 mm (0.4 in.)



700 010

**Kinetronics
„Static Wisk®“
Antistatic Brush**

For cleaning sensitive surfaces and removing static charges at the same time. Mixture of highly flexible natural fibres and conductive synthetic fibres, handle made of conductive plastic. Washable.

- 700 020:** SW-020, 20 mm (0.8 in.)
- 700 030:** SW-030, 30 mm (1.2 in.)
- 700 060:** SW-060, 60 mm (2.4 in.)
- 700 100:** SW-100, 100 mm (3.9 in.)



700 030

700 060

700 100



**Kinetronics
„MiniStat® Antistatic Film Cleaner**

For films and templates for scanners, printers, minilabs, enlargers and projection equipment. Two antistatic brushes mounted in a solid steel frame, which can be screwed in place for stationary use or be positioned using the enclosed magnets. The brushes can be removed for cleaning.

705 035: MS-035, for 35mm/APS films

705 070: MS-070, for films up to 70 mm (2.8 in.) width (120/620 roll film)

705 100: MS-100, for films up to 4 x 5"

705 200: MS-200, for films up to 8 x 10"



**Kinetronics
„KineStat® Antistatic Film Cleaning Unit**

KineStat: With three antistatic brushes mounted in a solid steel frame. With ground wire.

709 035: KS-035, for 35mm film, 35mm (1.4 in.)

709 070: KS-070, for 120/620 films, 70mm (2.8 in.)

709 100: KS-100, for 4 x 5", 100mm (3.9 in.)

709 200: KS-200, for 8 x 10", 200mm (7.9 in.)

KineStat Electric: With four antistatic brushes and ventilator blowing away demagnetized dust particles. Exchangeable micro filter for sucked-in air.

719 035: KSE-035, for 35 mm film, 35mm

719 070: KSE-070, for 120/620 films, 70mm

719 100: KSE-100, for 4 x 5", 100mm (3.9 in.)

719 200: KSE-200, for 8 x 10", 200mm (7.9 in.)



**707 001
Kinetronics
Outdoor Photographer's
Optical Cleaning Kit**

Cleaning kit for outdoor photography. For camera, lenses, binoculars, viewfinders etc.

Sturdy plastic box contains:

- Precision cleaning solution for lenses and viewfinders
- Panther antistatic cleaning cloth
- SW-020 antistatic brush
- SpeckGRABBER SG for removing dirt particles from lenses and sensors
- cleaning swabs



**707 025
Kinetronics
„ECK“ Optical Cleaning Kit**

Small kit for wet cleaning of lenses, glasses etc. Antistatic effect. Contains Panther antistatic cleaning cloth 13 x 14.5 cm (5.1 x 5.7 in.) and 6 ml (0.2 oz.) drip bottle with cleaning solution.

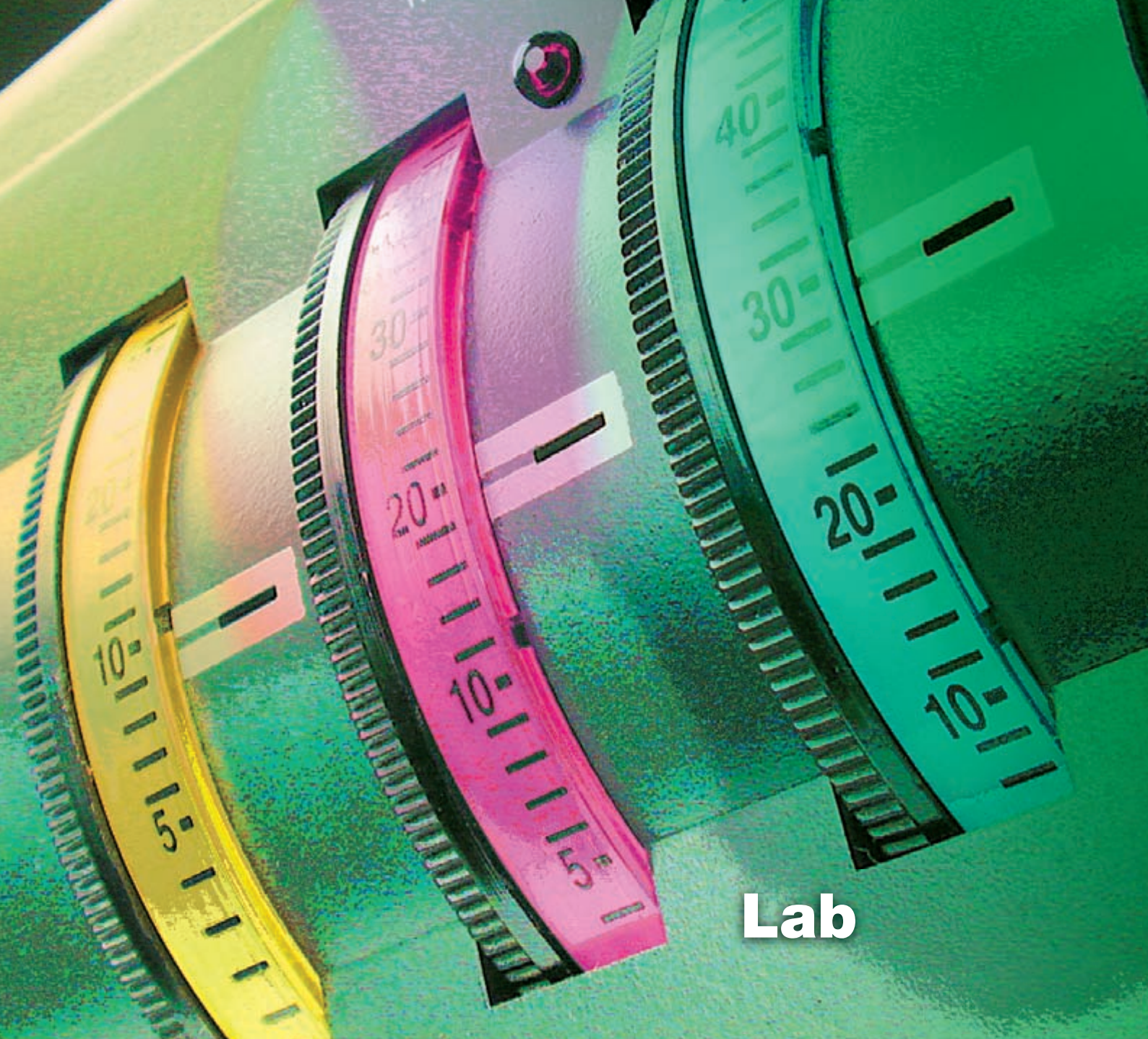

Lab

The Home Lab: Pictures of an Analog World

There is no doubt: The real world is analog. We understand „analog“ as the complement to „digital“. Everything that surrounds us – light, materials, sounds – we perceive as an analog presentation, as a continuous, i.e. a continuously changing „signal“.

The decision, whether you will make images of our real world as analog or digital „signals“, that is to say shoot analog or digital pictures, is of basic fundamental importance. The same applies to the further processing of the analog or digital image. Even though shooting digital or analog as a procedure is almost the same, the home lab as the place for analog processing is a completely different world.

Digital processing requires knowledge about computers and software for processing digital images.

On the other hand working in a home lab needs handicraft skills and requires practical as well as specific knowledge. The enjoyment for handicraft work is the most important motivation for „making pictures“ in your own home-lab. In some way the results of this work can be seen as pieces of art. Take into consideration, that the home lab worker uses the same materials as the professional, then he could produce professional results, something you normally have to spend big money for.

Working in an own home lab is also very often a pleasing compensation for your professional work, nowadays done very often in front of a computer monitor. There are many people who do not like to continue that in their free time.

There are even more reasons to do your own processing, printing and enlarging. Your home lab offers invaluable advantages when you make enlargements bigger than 30 x 40 cm or 12 x 16“. At these scales you can clearly recognize another property of the analog image recording procedure: the continuous tone increase from the deepest shadows to the brightest highlights.



The pictures produced in a home lab are also very durable. Especially black-and-white pictures printed on baryta paper can reach an age of more than 100 years if they are properly processed and stored. Viewing these images requires no additional tools, even the human eye is an analog sensor.

For approximately comparable quality with large format prints professional wide-format inkjet printers are required. Comparable life time can only be achieved by using pigment based inks in connection with archive durable inkjet papers. To get a color rendition in as much detail as possible or many gray tones bet-

ween deep black and bright white your printer needs 10 to 12 color, black and gray inks – copy costs for one print are correspondingly high.

The craftsman in his home lab needs suitable and reliable tools for his „picture workshop“. The core piece is the enlarger, an appliance which does the exposure by projecting the film image on the photographic paper. Kaiser offers a flexible and well-engineered enlarger system and every „image craftsman“ can make an adequate and reasonable choice – analog after all (Greek: „ana“ = according to + „logos“ = reason).



Photographie: Carlo Lecuit



Photographie: Ivana Grujić

SYSTEM-V: A Concept with a System

The Kaiser SYSTEM-V is the consistent implementation of the modular concept to an entire range of enlargers. It is not only characterized by the upgradability to different lighting heads and formats, all the items in the system are compatible with all the units. The complete modularisation of the enlarger

is the unmistakable feature of SYSTEM-V. It also permits an enlarger to be assembled from the various system modules to completely suit your individual needs. So you can get a model out of the box or have one tailor-made for you as well.

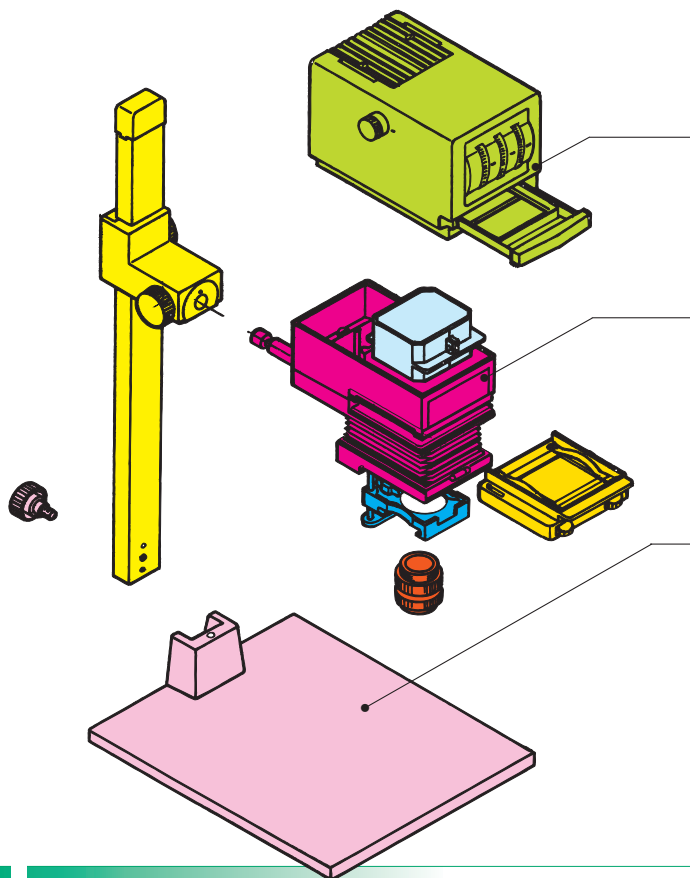

The hardware side of the SYSTEM-V concept is based on three separate assemblies.

1. The lighting components

The „heads“ determine the type of light and beam, the filtration and light mixing features. They decide whether the complete machine is a color or black-and-white enlarger.

2. The format-determinative components

„Format“ is defined here as the maximum enlargeable negative format. These components include the condenser system, the inserts for the compound negative carrier, and the enlarger lens. They decide whether the machine is a 35 mm enlarger or a medium-format one for 6 x 6 cm, 6 x 7 cm or 6 x 9 cm.

3. The dimension-determinative components

These include the base board and column and their dimensions – The width times the depth and column height determine the overall machine sizes.

Everything under Control

	Type	Code no.	Negative format				Focusing Enlarging				Specials	Negative carrier		Enlarger head										Lighting		Base board										
			up to 6 x 9 cm (2.4 x 3.5")	up to 6 x 7 cm (2.4 x 2.8")	up to 6 x 6 cm (2.4 x 2.4")	up to 24 x 36 mm (35 mill)	wall and floor projection	scale display	height adjustment with friction drive	weight balance with roll spring		focus with fine drive	max. enlargement (linear) on baseboard	Scheimpflug rectification	interchangeable	mask/glass insert top 2)	mask/glass insert bottom 2)	adjustable masking strips	color head with dichroic filters	filter values, densitometric to 180	scale wheels illuminated	white-light lever/density diaphragm	double condensor	filter drawer/spirit level	diffuser, UV filter, IR filter	red filter	quick-change lens attachment	filter holder	direct, 75 W opal lamp	reflex, 100 W cold light mirror lamp 3)	50 x 60 cm (19.5 x 23.5")	45 x 50 cm (17.5 x 19.5")				
Color enlargers	VCP 9005	4550	●				●	●	●	●	●	6.0	●	●	AN	P	●	●	●	●	●	●	●	●	●	●	●	●	●	●	●	●	●	●	●	●
	VCP 7005	4480		●			●	●	●	●	●	7.2	●	●	AN	M	●	●	●	●	●	●	●	●	●	●	●	●	●	●	●	●	●	●	●	●
	VCP 6005	4460			●		●	●	●	●	●	8.4	●	●	AN	M	●	●	●	●	●	●	●	●	●	●	●	●	●	●	●	●	●	●	●	●
	VCP 3505	4420				●	●	●	●	●	●	14.6	●	●	M	M	●	●	●	●	●	●	●	●	●	●	●	●	●	●	●	●	●	●	●	●
Multigrade®	VPM 9005	4560	●				●	●	●	●	●	6.0	●	●	AN	P	●	1)	1)	●	●	●	●	●	●	●	●	●	●	●	●	●	●	●	●	●
	VPM 7005	4471		●			●	●	●	●	●	7.2	●	●	AN	M	●	1)	1)	●	●	●	●	●	●	●	●	●	●	●	●	●	●	●	●	●
	VPM 6005	4530			●		●	●	●	●	●	8.4	●	●	AN	M	●	1)	1)	●	●	●	●	●	●	●	●	●	●	●	●	●	●	●	●	●
	VPM 3505	4426				●	●	●	●	●	●	14.6	●	●	M	M	●	1)	1)	●	●	●	●	●	●	●	●	●	●	●	●	●	●	●	●	●
B&W enlargers	VP 9005	4540	●				●	●	●	●	●	6.0	●	●	AN	P	●																			
	VP 7005	4470		●			●	●	●	●	●	7.2	●	●	AN	M	●																			
	VP 6005	4465			●		●	●	●	●	●	8.4	●	●	AN	M	●																			
	VP 3505	4425				●	●	●	●	●	●	14.6	●	●	AN	M	●																			

1) Multigrade head 2) AN = Anti-Newton-glass, M = mask, P = flat glass 3) Transformer required



4450/4480

Color Enlargers SYSTEM-V

General specifications:

Color mixing head with dichroic interference filters, calibrated in densitometric values up to 180. Dials are indirectly illuminated. White-light lever for simultaneous swinging in or out of filters, with control light. Continuously adjustable density aperture up to 60 densitometric densities (= two aperture settings). Best possible light distribution due to special diffusor plate and exchangeable double condenser system. UV and IR filters. Filter drawer.

Removable compound negative carrier with interchangeable inserts, adjustable masking strips, adjustable film stops and grid pins. Lens stage with spirit level and red filter, tilt-able for distortion correction on Scheimpflug principle. Quick change attachment for lenses. Height adjustment by hand-crank operated friction drive on plastic bearings. Wall and floor projection possible.

Wide, vibration-resistant column of embossed aluminium tubing, with dull black anodized surface, cm and inch scales and markings for enlarging scales. Matt-gray laminated base board with individually height-adjustable feet. Spirit level on column base.

Technical specifications:

Lamp: Halogen cold light mirror lamp,
12 V, 100 W, socket GZ 6.35

Cord: approx. 1.80 m (6 ft.)

Filter drawer: 85 x 85 mm (3.3 x 3.3 in.)

Column (HxWxD): approx. 1000 x 70 x 35 mm
(39.4 x 2.8 x 1.4 in.)

Distance between optical axis and column
base: approx. 220 mm (8.7 in.).

Can be converted into a copy stand or a
slide duplicator.

Scope of supply: Incl. compound negative
carrier, lamp and dust hood, without lens,
without transformer.



4459

4550
VCP 9005

Color enlarger for all film formats up to 6 x 9 cm (2.4 x 3.5 in.) and lenses up to 105 mm focal length.

Compound negative carrier fitted with Anti-Newton glass on top and flat glass on bottom.

Focusing with additional fine drive. Height adjustment with weight compensation by a roll-off spring mechanism.

Filter holder for square filters and framed Multigrade® filters, can be swung out and adjusted in height, with diffusor plate for integral metering.

Base board (WxDxH): approx. 600 x 500 x 32 mm (23.6 x 19.7 x 1.3 in.)

4480
VCP 7005

Color enlarger for all film formats up to 6 x 7 cm (2.4 x 2.8 in.) and lenses up to 105 mm focal length. Can be converted to a 6 x 9 enlarger.

Compound negative carrier fitted with Anti-Newton glass on top and 6 x 7 format mask on bottom.

Focusing with additional fine drive. Height adjustment with weight compensation by a roll-off spring mechanism.

Filter holder for square filters and framed Multigrade® filters, can be swung out and adjusted in height, with diffusor plate for integral metering.

Base board (WxDxH): approx. 600 x 500 x 32 mm (23.6 x 19.7 x 1.3 in.)

4460
VCP 6005

Color enlarger for all film formats up to 6 x 6 cm (2.4 x 2.4 in.) and lenses up to 80 mm focal length. Can be converted to formats up to 6 x 9 cm.

Compound negative carrier fitted with Anti-Newton glass on top and 6 x 6 format mask on bottom.

Base board (WxDxH): approx. 450 x 500 x 28 mm (17.7 x 19.7 x 1.1 in.)

4420
VCP 3505

Color enlarger for 35 film (24 x 36 mm) and lenses up to 50 mm focal length. Can be converted to formats up to 6 x 9 cm.

Compound negative carrier fitted with 35 mm (24 x 36 mm) format masks.

Base board (WxDxH): approx. 450 x 500 x 28 mm (17.7 x 19.7 x 1.1 in.)





4560/4471

Multigrade® Enlargers SYSTEM-V

General specifications:

Multigrade® head with dichroic color filter for use with variable gradation paper without changing the exposure time. Scale dial indirectly illuminated with index numbers in half steps from 0 (extra soft) to 5 (extra hard) for stepless contrast control. White-light lever for simultaneous swinging in or out of filters, with control light. Continuously adjustable density aperture up to 60 densitometric densities (= two aperture settings). Best possible light distribution due to special diffusor plate and exchangeable double condensor system. UV and IR filters. Filter drawer.

Removable compound negative carrier with interchangeable inserts, adjustable masking strips, adjustable film stops and grid pins. Lens stage with spirit level and red filter, tiltable for distortion correction on Scheimpflug principle. Quick change attachment for lenses. Height adjustment by hand-crank operated friction drive on plastic bearings. Wall and floor projection possible.

Wide, vibration-resistant column of embossed aluminium tubing, with dull black anodized surface, cm and inch scales and markings for enlarging scales. Matt-gray laminated base board with individually height-adjustable feet. Spirit level on column base.

Technical specifications:

Lamp: Halogen cold light mirror lamp, 12 V, 100 W, socket GZ 6.35
 Cord: approx. 1.80 m (6 ft.)
 Filter drawer: 85 x 85 mm (3.3 x 3.3 in.)
 Column (HxWxD): approx. 1000 x 70 x 35 mm (39.4 x 2.8 x 1.4 in.)
 Distance between optical axis and column base: approx. 220 mm (8.7 in.)

Can be converted into a copy stand.

Scope of supply: Incl. compound negative carrier, lamp and dust hood, without lens, without transformer.



4459

4560
VPM 9005

Multigrade® enlarger for all film formats up to 6 x 9 cm (2.4 x 3.5 in.) and lenses up to 105 mm focal length.

Compound negative carrier fitted with Anti-Newton glass on top and flat glass on bottom.

Focusing with additional fine drive. Height adjustment with weight compensation by a roll-off spring mechanism.

Filter holder for square filters and framed Multigrade® filters, can be swung out and adjusted in height, with diffusor plate for integral metering.

Base board (WxDxH): approx. 600 x 500 x 32 mm (23.6 x 19.7 x 1.3 in.)

4471
VPM 7005

Multigrade® enlarger for all film formats up to 6 x 7 cm (2.4 x 2.8 in.) and lenses up to 105 mm focal length. Can be converted to a 6 x 9 enlarger.

Compound negative carrier fitted with Anti-Newton glass on top and 6 x 7 format mask on bottom.

Focusing with additional fine drive. Height adjustment with weight compensation by a roll-off spring mechanism.

Filter holder for square filters and framed Multigrade® filters, can be swung out and adjusted in height, with diffusor plate for integral metering.

Base board (WxDxH): approx. 600 x 500 x 32 mm (23.6 x 19.7 x 1.3 in.)

4530
VPM 6005

Multigrade® enlarger for all film formats up to 6 x 6 cm (2.4 x 2.4 in.) and lenses up to 80 mm focal length. Can be converted to formats up to 6 x 9 cm.

Compound negative carrier fitted with Anti-Newton glass on top and 6 x 6 format mask on bottom.

Base board (WxDxH): approx. 450 x 500 x 28 mm (17.7 x 19.7 x 1.1 in.)

4426
VPM 3505

Multigrade® enlarger for 35 film (24 x 36 mm) and lenses up to 50 mm focal length. Can be converted to formats up to 6 x 9 cm.

Compound negative carrier fitted with 35 mm (24 x 36 mm) format masks.

Base board (WxDxH): approx. 450 x 500 x 28 mm (17.7 x 19.7 x 1.1 in.)



Multigrade is a registered trademark of Ilford Ltd.



B & W Enlargers SYSTEM-V

General specifications:

Lamp head with 75 W opal lamp, lamp adjustable. Exchangeable double condensor system. Filter drawer.

Removable compound negative carrier with interchangeable inserts, adjustable masking strips, adjustable film stops and grid pins. Lens stage with spirit level and red filter, tilt-able for distortion correction on Scheimpflug principle. Quick change attachment for lenses. Height adjustment by hand-crank operated friction drive on plastic bearings. Wall and floor projection possible.

Wide, vibration-resistant column of embossed aluminium tubing, with dull black anodized surface, cm and inch scales and markings for enlarging scales. Matt-gray laminated base board with individually height-adjustable feet. Spirit level on column base.

Technical specifications:

Lamp: Opal lamp 75 W, E 27 socket

Cord: approx. 2.50 m (8 ft. 2 in.)

Filter drawer: 85 x 85 mm (3.3 x 3.3 in.)

Column (HxWxD): approx. 1000 x 70 x 35 mm (39.4 x 2.8 x 1.4 in.)

Distance between optical axis and column base: approx. 220 mm (8.7 in.).

Can be converted into a copy stand.

Scope of supply: Incl. compound negative carrier, lamp and dust hood, without lens.



4356

4540
VP 9005

B & W enlarger for all film formats up to 6 x 9 cm (2.4 x 3.5 in.) and lenses up to 105 mm focal length.

Compound negative carrier fitted with Anti-Newton glass on top and flat glass on bottom.

Focusing with additional fine drive. Height adjustment with weight compensation by a roll-off spring mechanism.

Filter holder for square filters and framed Multigrade® filters, can be swung out and adjusted in height, with diffusor plate for integral metering.

Base board (WxDxH): approx. 600 x 500 x 32 mm (23.6 x 19.7 x 1.3 in.)

4470
VP 7005

B & W enlarger for all film formats up to 6 x 7 cm (2.4 x 2.8 in.) and lenses up to 105 mm focal length. Can be converted to a 6 x 9 enlarger.

Compound negative carrier fitted with Anti-Newton glass on top and 6 x 7 format mask on bottom.

Focusing with additional fine drive. Height adjustment with weight compensation by a roll-off spring mechanism.

Filter holder for square filters and framed Multigrade® filters, can be swung out and adjusted in height, with diffusor plate for integral metering.

Base board (WxDxH): approx. 600 x 500 x 32 mm (23.6 x 19.7 x 1.3 in.)

4465
VP 6005

B & W enlarger for all film formats up to 6 x 6 cm (2.4 x 2.4 in.) and lenses up to 80 mm focal length. Can be converted to formats up to 6 x 9 cm.

Compound negative carrier fitted with Anti-Newton glass on top and 6 x 6 format mask on bottom.

Base board (WxDxH): approx. 450 x 500 x 28 mm (17.7 x 19.7 x 1.1 in.)

4425
VP 3505

B & W enlarger for 35 film (24 x 36 mm) and lenses up to 50 mm focal length. Can be converted to formats up to 6 x 9 cm.

Compound negative carrier fitted with 35 mm (24 x 36 mm) format masks.

Base board (WxDxH): approx. 450 x 500 x 28 mm (17.7 x 19.7 x 1.1 in.)



Specs and More: A Survey

SYSTEM-V			VCP 9005	4550	VCP 7005	4480	VCP 6005	4460	VCP 3505	4420	VPM 9005	4560	VPM 7005	4471	VPM 6005	4530	VPM 3505	4426	VP 9005	4540	VP 7005	4470	VP 6005	4465	VP 3505	4425	also for use with previous SYSTEM-V models	also for use with VP 350 (4401)		
Base Boards and Accessories	4472	Base Board 45 x 50 cm (17.7 x 19.7 in.)	○	○	●	●	●	●	○	○	○	○	○	○	○	○	○	○	○	○	○	○	○	○	○	○	○	○		
	4413	Base Board 50 x 60 cm (19.7 x 23.6 in.)	●	●	○	○	○	○	○	○	○	○	○	○	○	○	○	○	○	○	○	○	○	○	○	○	○	○		
	4414	Base Board 60 x 80 cm (23.6 x 31.5 in.)	○	○	○	○	○	○	○	○	○	○	○	○	○	○	○	○	○	○	○	○	○	○	○	○	○	○		
	5508	Base Stand	○	○	○	○	○	○	○	○	○	○	○	○	○	○	○	○	○	○	○	○	○	○	○	○	○	○		
Columns and Accessories	4473	Column w/o weight compensation, 1 m (40 in.)	○	○	●	●	●	●	○	○	○	○	○	○	○	○	○	○	○	○	○	○	○	○	○	○	○	○		
	4474	Column with weight compensation, 1 m (40 in.)	●	●	○	○	○	○	○	○	○	○	○	○	○	○	○	○	○	○	○	○	○	○	○	○	○	○		
	4475	Column w/toothed rack and fine drive, 1 m (40 in.)	○	○	○	○	○	○	○	○	○	○	○	○	○	○	○	○	○	○	○	○	○	○	○	○	○	○		
	4476	Column with toothed rack, 1 m (40 in.)	○	○	○	○	○	○	○	○	○	○	○	○	○	○	○	○	○	○	○	○	○	○	○	○	○	○	○	
	4408	Column with toothed rack, 1.2 m (47 in.)	○	○	○	○	○	○	○	○	○	○	○	○	○	○	○	○	○	○	○	○	○	○	○	○	○	○	○	
	4409	Column with weight compensation, 1.5 m (60 in.)	○	○	○	○	○	○	○	○	○	○	○	○	○	○	○	○	○	○	○	○	○	○	○	○	○	○	○	
	4412	Wall Mount	○	○	○	○	○	○	○	○	○	○	○	○	○	○	○	○	○	○	○	○	○	○	○	○	○	○	○	
4455	Extension Arm	○	○	○	○	○	○	○	○	○	○	○	○	○	○	○	○	○	○	○	○	○	○	○	○	○	○	○		
Enlarger Head Lower Part and Accessories	4568	Enlarger Head Lower Part	●	●	●	●	●	●	●	●	●	●	●	●	●	●	●	●	●	●	●	●	●	●	●	○	○	○		
	4423	Lens Holder Ring up to 50 mm focal length	●	●	●	●	●	●	●	●	●	●	●	●	●	●	●	●	●	●	●	●	●	●	●	○	○	○	○	
	4424	Lens Holder Ring 60 – 105 mm focal length	●	●	●	●	●	●	●	●	●	●	●	●	●	●	●	●	●	●	●	●	●	●	●	○	○	○	○	
Enlarger Heads and Accessories		B&W Head, for formats up to 6 x 6 cm	○	○	○	○	○	○	○	○	○	○	○	○	○	○	○	○	○	○	○	○	○	○	○	○	○	○		
	4541	B&W Head, for formats up to 6 x 9 cm	○	○	○	○	○	○	○	○	○	○	○	○	○	○	○	○	○	○	○	○	○	○	○	○	○	○	○	
	4544	Color Head with density aperture	●	●	●	●	○	○	○	○	○	○	○	○	○	○	○	○	○	○	○	○	○	○	○	○	○	○	○	
	4545	Multigrade Head with density aperture	○	○	○	○	○	○	○	○	○	○	○	○	○	○	○	○	○	○	○	○	○	○	○	○	○	○	○	
	4451	Transformer with voltage stabilization	○	○	○	○	○	○	○	○	○	○	○	○	○	○	○	○	○	○	○	○	○	○	○	○	○	○	○	
	4453	Transformer w/o voltage stabilization	○	○	○	○	○	○	○	○	○	○	○	○	○	○	○	○	○	○	○	○	○	○	○	○	○	○	○	○
	4356	Opal Lamp, 75 Watt	-	-	-	-	-	-	-	-	-	-	-	-	-	-	-	-	-	-	-	-	-	-	-	-	-	-	-	
	4459	Halogen Cold Light Mirror Lamp	●	●	●	●	○	○	○	○	○	○	○	○	○	○	○	○	○	○	○	○	○	○	○	○	○	○	○	
Condensor Systems	4443	Double Condensor for formats up to 35 mm	○	○	○	○	○	○	○	○	○	○	○	○	○	○	○	○	○	○	○	○	○	○	○	○	○	○		
	4542	Double Condensor for formats up to 6 x 6 cm	○	○	○	○	○	○	○	○	○	○	○	○	○	○	○	○	○	○	○	○	○	○	○	○	○	○	○	
	4449	Double Condensor for formats up to 6 x 9 cm	●	●	○	○	○	○	○	○	○	○	○	○	○	○	○	○	○	○	○	○	○	○	○	○	○	○	○	
Compound Negative Carrier System	4583	Compound Negative Carrier w/o inserts	●	●	●	●	●	●	●	●	●	●	●	●	●	●	●	●	●	●	●	●	●	●	●	○	○	○		
	4493	Comp. Neg. Car. w. 6x6 mask/AN-glass for border exp.	○	○	○	○	○	○	○	○	○	○	○	○	○	○	○	○	○	○	○	○	○	○	○	○	○	○	○	
	4584	Compound Negative Carrier for 7 x 7 cm slides	○	○	○	○	○	○	○	○	○	○	○	○	○	○	○	○	○	○	○	○	○	○	○	○	○	○	○	
	4486	Pair of Format Masks 24 x 36 mm (35 mm)	○	○	○	○	○	○	○	○	○	○	○	○	○	○	○	○	○	○	○	○	○	○	○	○	○	○	○	
	4491	Pair of Format Masks 24.5 x 36.5 mm, border exposure	○	○	○	○	○	○	○	○	○	○	○	○	○	○	○	○	○	○	○	○	○	○	○	○	○	○	○	
	4431	Pair of Format Masks 4.5 x 6 cm	○	○	○	○	○	○	○	○	○	○	○	○	○	○	○	○	○	○	○	○	○	○	○	○	○	○	○	○
	4485	Pair of Format Masks 6 x 6 cm	○	○	○	○	○	○	○	○	○	○	○	○	○	○	○	○	○	○	○	○	○	○	○	○	○	○	○	○
	4436	Pair of Format Masks 6 x 7 cm	○	○	○	○	○	○	○	○	○	○	○	○	○	○	○	○	○	○	○	○	○	○	○	○	○	○	○	○
	4487	Pair of AN Glass Inserts	○	○	○	○	○	○	○	○	○	○	○	○	○	○	○	○	○	○	○	○	○	○	○	○	○	○	○	○
	4490	Pair of Flat Glass Inserts	○	○	○	○	○	○	○	○	○	○	○	○	○	○	○	○	○	○	○	○	○	○	○	○	○	○	○	○
	4433	Inserts AN Glass/Flat Glass	●	●	○	○	○	○	○	○	○	○	○	○	○	○	○	○	○	○	○	○	○	○	○	○	○	○	○	○
	4435	Inserts 24 x 36 Mask/AN Glass	○	○	○	○	○	○	○	○	○	○	○	○	○	○	○	○	○	○	○	○	○	○	○	○	○	○	○	○
	4434	Inserts 6 x 6 Mask /AN Glass	○	○	○	○	○	○	○	○	○	○	○	○	○	○	○	○	○	○	○	○	○	○	○	○	○	○	○	○
	4432	Inserts 6 x 7 Mask/AN Glass	○	○	○	○	○	○	○	○	○	○	○	○	○	○	○	○	○	○	○	○	○	○	○	○	○	○	○	○
4489	Format Mask for 5 x 5 cm slides	○	○	○	○	○	○	○	○	○	○	○	○	○	○	○	○	○	○	○	○	○	○	○	○	○	○	○	○	
4492	Pair of Panorama Format Masks 24 x 66 mm	○	○	○	○	○	○	○	○	○	○	○	○	○	○	○	○	○	○	○	○	○	○	○	○	○	○	○	○	
4494	Pair of Masks for own cut-out	○	○	○	○	○	○	○	○	○	○	○	○	○	○	○	○	○	○	○	○	○	○	○	○	○	○	○	○	
General Accessories	4495	Filter Holder	●	●	○	○	○	○	○	○	○	○	○	○	○	○	○	○	○	○	○	○	○	○	○	○	○	○		
	4496-99	Screw-On Filter Adapter	○	○	○	○	○	○	○	○	○	○	○	○	○	○	○	○	○	○	○	○	○	○	○	○	○	○	○	
	4448	Filter Drawer 85 x 85 mm	○	○	○	○	○	○	○	○	○	○	○	○	○	○	○	○	○	○	○	○	○	○	○	○	○	○	○	

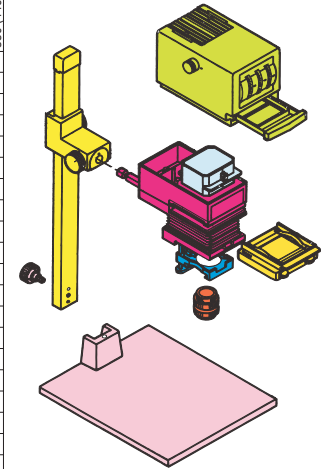

All SYSTEM-V enlargers can be converted into copy stands using the components of the R1 copy system (see pages 83-95).

- Standard equipment
- Combination possible, additional components could be necessary
- Combination not possible

4401
VP 350 B & W Enlarger



4356

For sizes up to 24 x 36 mm (35 mm film) and lenses up to 50 mm focal length. Floor projection possible. Removable compound negative carrier with negative masks for size 24 x 36 mm and slide sizes 5 x 5 cm (2 x 2 in.). Optically ground single condenser. Red filter within bellows extension for dust protection. Can accommodate filter drawer. Height adjustment by hand crank-operated friction drive on plastic bearings. Column with cm and inch scales.

The enlarger is convertible to sizes up to 6 x 9 cm and to a Color or Multigrade enlarger.

Supplied with compound negative carrier and lamp, without lens.

Specifications:

Base board (WxDxH): approx. 400 x 420 x 25 mm (15.7 x 16.5 x 1 in.)

Height of column: approx. 760 mm (30 in.)

Maximum enlargement on base board:
24 x 30 cm (9.4 x 4.8 in.)

Lamp: Opal lamp 75 W

Cord: ca. 2.50 m (8 ft. 2 in.)



4403
AN Glass Insert

Glass insert with specially etched contact surface to prevent Newton rings. For insertion into the upper part of the compound negative carrier of the VP 350.

Dimensions: 50 x 52 mm (2 x 2 in.)

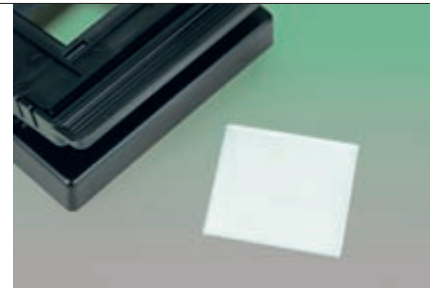

5421
RA 2 XA Copy Adapter

To convert the VP 350 to a copy stand. Horizontally adjustable. 1/4" camera thread.





4473-76/4408-09 Column

Made of aluminium tubing, dull black anodized surface, with cm and inch scales and markings for enlarging scales. With mount and fastening for lower part enlarger head 4568. Height adjustment by hand crank.

4473: Height adjustment by friction drive with plastic bearings, without weight compensation, height 1 m (40 in.).

4474: Height adjustment by friction drive with plastic bearings, with weight compensation by built-in roller-spring, height 1 m (40 in.).

4475: Rack-and-pinion height adjustment, with weight compensation by built-in roller-spring, additional 1:10 fine drive. Locking screw for fixing the adjusted height. Height 1 m (40 in.).

4476: same as 4475, but without fine drive.

4408: Rack-and-pinion height adjustment, with weight compensation by built-in roller-spring. Locking screw for fixing the adjusted height. Height 1.2 m (47 in.).

4409: Height adjustment by friction drive with plastic bearings, with weight compensation by built-in roller-spring, Locking screw for fixing the adjusted height. Height 1.5 m (60 in.).

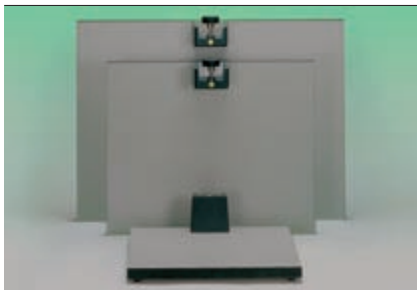

4472/4413-14 Base Board

Matt-gray base board with column base fixed for attaching column. Spirit level in column base. Individually height-adjustable feet.

Dimensions (WxHxD):

4472: approx. 450 x 28 x 500 mm
(17.7 x 1.1 x 19.7 in.)

4413: approx. 600 x 32 x 500 mm
(23.6 x 1.3 x 19.7 in.)

4414: approx. 800 x 32 x 600 mm
(31.5 x 1.3 x 23.6 in.)

(Dimensions without base and feet)



5508 Base Stand

For converting all SYSTEM-V enlargers from table to free-standing models. Also suitable for all Kaiser base boards from 45 x 50 cm to 60 x 80 cm (17.7 x 19.7 in. to 23.6 x 31.5 in.) and for RSD copy stands. Height-adjustable feet.

Dimensions (WxHxD): approx. 580 x 510 x 595 mm (22.8 x 20.1 x 23.4 in.)

4412 Wall Mount

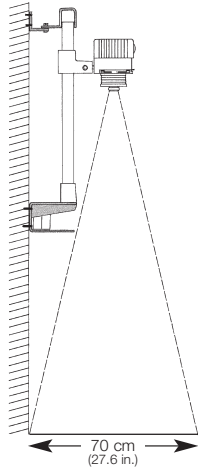

Strong wall mount for all Kaiser columns 70 mm (2.8 in.) wide. Required if projection is not made on base board but on larger-sized table or the floor, especially to achieve large enlarging scales.

Wall mounting with 6 screws. Upper part adjustable for absolutely vertical position. Lower part with base and spirit level and space for transformer.

Maximum possible enlargement with lens $f = 50$ mm: 70 x 105 cm (27.5 x 41.3 in.)
 $L = 29x$, linear.

Entire height with 1 m (40 in.) column: 1.16 m (46 in.)

Supplied with screws and dowels.



4455 Extension Arm

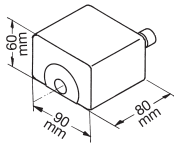

To extend the holding arm on enlargers. Required for large-dimension enlargements. This increases the distance between the optical axis and the base by 80 mm (3.1 in.). The extension arm is attached between the standard holding arm and the enlarger head. Dimensions (WxHxD): approx. 115 x 60 x 135 mm (4.5 x 2.4 x 5.3 in.)



4568 Enlarger Head Lower Part

Consists of condenser housing with bellows and lens stage, without condenser system and compound negative carrier. With lens adapter rings for lenses up to 50 mm and from 60 up to 105 mm focal length. Quick change attachment for easy lens mounting. Also required for converting Kaiser copy stands into enlargers.





4544 Color Head

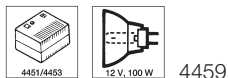

4459

Suitable for all Kaiser enlargers. Dichroic interference filters, calibration in densitometric units up to 180. Dials indirectly illuminated. White-light lever continuously adjustable, illuminated density aperture up to 60 densitometric densities (= two aperture settings). Best possible light distribution due to special diffusor plate. UV filter and IR filter. Drawer for additional filter. May only be operated with transformer 4451 and 4453. Supplied with halogen cold light mirror lamp (12 V, 100 W, socket GZ 6.35)
Filter drawer: 85 x 85 mm (3.3 x 3.3 in.)
Cord: 1.8 m (6 ft.)
Dimensions: approx. 160 x 250 x 125 mm (WxHxD) (6.3 x 5.9 x 8.8 in.)



4545 Multigrade® Head

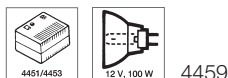

4459

Suitable for all Kaiser enlargers. With dichroic colour filter for processing variable contrast printing papers without changing the exposure time. Indirectly illuminated scale dial calibrated in half steps from 0 (extra soft) to 5 (extra hard) for stepless gradation control. White-light lever for simultaneous swinging in and out of filters, with control light. Continuously adjustable, illuminated density aperture up to 60 densitometric densities (= two aperture settings). Best possible light distribution due to special diffusor plate. UV filter and IR filter. Drawer for additional filter. May only be operated with transformer 4451 and 4453.
Supplied with halogen cold light mirror lamp (12 V, 100 W, socket 6.35). Same dimensions as with 4544.



4541 B & W Head



4356

Suitable for all Kaiser enlargers. Lamp adjustable. Drawer for additional filters. Supplied with opal lamp.
Specifications:
Lamp: Opal lamp, 75 W
Filter drawer: 85 x 85 mm (3.3 x 3.3 in.)
Cord: approx. 2.5 m (8.2 ft.), with cord switch
Dimensions: 145 x 150 x 245 mm (WxHxD) (5.7 x 5.9 x 9.6 in.)

**4451/4453
Transformer**

Output power: 100 W
Dimensions: approx. 120 x 80 x 140 mm
(4.7 x 3.1 x 5.5 in.)
Available for 230 V, 240 V and 120 V
Fuse: 1.6 AT (230/240V) / 2.5 AT (120V)

4451: with starting-current limitation and electronic voltage stabilization. For compensation of voltage deviations (for constant color temperature).

Input: 230 V, + 10%, -15%, 50 Hz
Output: 11.5 V ± 1%, 50 Hz

4453: without voltage stabilization
Input: 230 V, 50 Hz
Output: 12 V, 50 Hz



**4459
Halogen Cold-Light Mirror Lamp**

12 V, 100 W, 3200 K, average service life 50 hrs. Lamp with high light yield and constant light radiation and color temperature during the entire service life. Low heat stress on the film due to the cold-light mirror.



**4356
Opal Lamp**

75 W, E 27. Average service life 100 hrs. Lamp with bright light output. Uniform light density due to special inner coating of the bulb. Colour temperature: 3000 K



**4443/4449/4542
Double Condenser**

For SYSTEM-V enlargers. Simple fitting with two coin screws on the head base.

4449: for formats up to 6 x 9 cm (2.4 x 3.5 in.). Fits all enlargers made from 10/94 on (05 series).

4542: for formats up to 6 x 6 cm (2.4 x 2.4 in.)

4443: for formats up to 24 x 36 mm (35 mm).



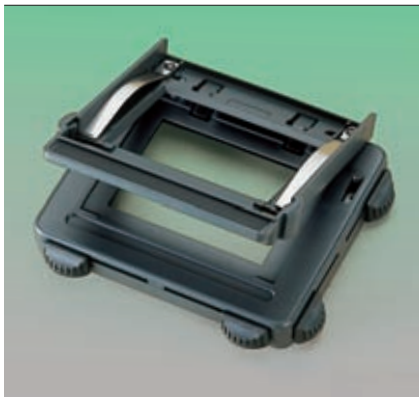

4583
Compound Negative Carrier

For use with all negative masks and glass inserts size 100 x 72.5 mm (3.9 x 2.9 in.). Suitable for all SYSTEM-V enlargers made from 10/94 on (05 series).

Adjustable guide pins for film widths 61.5 mm (rollfilm 120), 41 mm (rollfilm 127) and 35 mm film. Four steplessly adjustable masking strips for selecting the desired detail. Two grid pins at standard hole intervals.

Dimensions: approx. 142 x 37 x 123 mm
(5.6 x 1.4 x 4.8 in.)



4584
**Compound Negative Carrier
for 7 x 7 cm Slides**

For mounted 6 x 6 slides with outer dimensions 7 x 7 cm (2.8 x 2.8 in.). Suitable for all SYSTEM-V enlargers made from 10/94 on (05 series). Four steplessly adjustable masking strips for selecting the desired detail.

Dimensions: approx. 142 x 37 x 123 mm
(5.6 x 1.4 x 4.8 in.)



4493
**Compound Negative Carrier
for Border Exposure 6 x 6 cm**

For pictures with a black border. Comes with 6 x 6 format mask for border exposure and AN glass.

Also for use with all negative masks and glass inserts size 100 x 72.5 mm (3.9 x 2.9 in.). Suitable for all SYSTEM-V enlargers made from 10/94 on (05 series).

Adjustable guide pins for film widths 61.5 mm (rollfilm 120), 41 mm (rollfilm 127) and 35 mm film. Four steplessly adjustable masking strips for selecting the desired detail. Two grid pins at standard hole intervals.

Dimensions: approx. 142 x 37 x 123 mm
(5.6 x 1.4 x 4.8 in.)

Format Masks and Inserts

For insertion into the 4583 compound negative carrier of SYSTEM-V enlargers and for 4493 compound negative carrier.

Dimensions: approx. 100 x 72.5 mm
(3.9 x 2.9 in.)

4431/36/85/86/91/92 Format Masks

Pairs of masks.

4486: Format masks 24 x 36 mm (35 mm (a + b)). With guide ridges for film strips and neg number read-out window.

4491: Format masks 24.5 x 36.5 (a + b). For pictures with black border

4431: Format masks 4.5 x 6 cm

4485: Format masks 6 x 6 cm

4436: Format masks 6 x 7 cm

4492: Panorama format masks 24 x 66 mm, e.g. for Hasselblad X-pan, Noblex 135 and Mamiya 7 with 35 mm panorama insert.

4432/4434-35 Anti-Newton Glass/Mask

Pairs of inserts.

4435: AN glass/format mask 24 x 36 (b)

4434: AN glass/format mask 6 x 6 cm

4432: AN glass/format mask 6 x 7 cm

4433/87/90 Glass Inserts

Pairs of inserts.

4487: AN glass

4433: AN glass/flat glass

4490: Flat glass

4489 Format Mask

For mounted 35 mm slides with 5 x 5 cm (2 x 2 in.) outer dimensions.

4494 Inserts

Without cut-out. For „do-it-yourself“ cut.
1 pair.

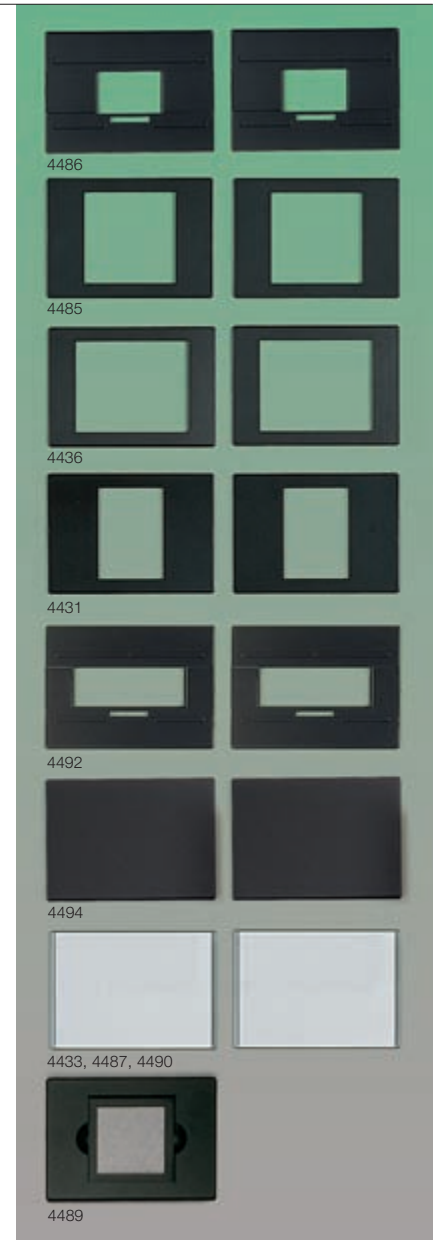



Rodenstock Enlarging Lenses

Rogonar: For enlarging scales up to 4:1. For almost all B&W work, can be used for color enlarging with some restrictions.

Rogonar-S: Almost unlimited application in B & W enlarging, in color up to enlarging scales of approx. 10:1.

Rodagon: Almost unlimited application for all B & W and color enlarging.

Apo-Rodagon N: For highest standards. Brilliant color reproduction with apochromatic correction.



Code no.	Designation	Lens speed	Focal length	Elements	Click-stop disengaging	Aperture presetting	Aperture scale illuminated	Filter thread	max. film format
4363	Rodagon-WA	4.0	40 mm	6	•	•	•	40.5 mm	24 x 36 mm
4355	Rogonar	2.8	50 mm	3	-	-	•	-	
4365	Rogonar-S	2.8	50 mm	4	•	•	•	40.5 mm	
4367	Rodagon	2.8	50 mm	6	•	•	•	40.5 mm	
4469	Apo-Rodagon N	2.8	50 mm	6	•	•	•	40.5 mm	
4360	Rogonar-S	4.5	75 mm	4	•	•	•	40.5 mm	6 x 6 cm
4341	Rodagon	4.0	80 mm	6	•	•	•	40.5 mm	6 x 7 cm
4340	Apo-Rodagon N	4.0	80 mm	7	•	•	•	40.5 mm	6 x 9 cm
4327	Rodagon	5.6	105 mm	6	•	•	•	40.5 mm	
4329	Apo-Rodagon N	4.0	105 mm	7	•	•	•	40.5 mm	
4349	Apo-Compton HM	2.8	40 mm	6	•	•	•	43 mm	24 x 36 mm
4336	Apo-Compton HM	4.0	45 mm	6	•	•	•	43 mm	
4382	Compton-S	2.8	50 mm	6	•	•	•	43 mm	
4350	Apo-Compton HM	4.0	60 mm	6	•	•	•	43 mm	6 x 6 cm
4384	Compton-S	4.0	80 mm	6	•	•	•	43 mm	6 x 7 cm
4337	Apo-Compton HM	4.5	90 mm	6	•	•	•	43 mm	6 x 9 cm
4338	Compton-S	5.6	100 mm	6	•	•	•	43 mm	

All enlarging lenses with M 39 x 1 mounting thread.

4423-24 Lens Holder Ring

Rodagon-WA: Wide-angle lens for highest performance. For achieving large enlarging scales at normal distance to base board.

Schneider Enlarging Lenses

Compton-S: For highest demands and all enlarging scales.

Apo-Compton HM: Apochromatic corrected lens for highest demands and all enlarging scales.

For the fast mounting of lenses on SYSTEM-V enlargers made from 10/94 on (05 series).

4423: for lenses up to 50 mm focal length

4424: for lenses from 60 to 105 mm focal length

4495
Filter Holder for Enlargers

Device for positioning filters and masks below the enlarging lens. For all Kaiser enlargers built after 1981. Mounted on vertical parallel rods. Height of filter tray steplessly adjustable, can be swung out of line of beam. Two grooved insertion planes for square filter plates (for filters between 64 and 67 mm (2.5 and 2.6 in.) width and 2 mm (.1 in.) max. thickness) and for adapters for screw-on filters. One grooved insertion plane for masks, pinhole diaphragms etc. up to 1.5 mm (.06 in.) max. thickness. Special holding device for framed filters for variable contrast printing papers. Supplied with red filter and diffusor plate for integral metering.

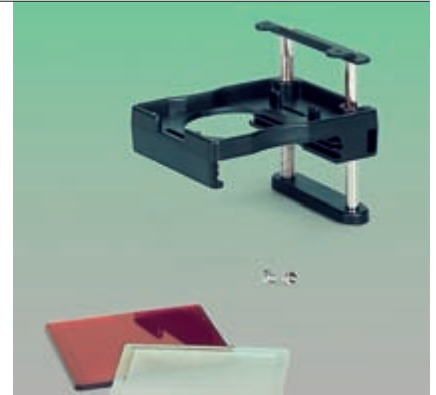

4496-99
Screw-on Filter Adapter

Allows for the use of screw-on filters with filter holder 4495.

- 4496:** for screw-on filter \varnothing 49 mm (1.9 in.)
- 4497:** for screw-on filter \varnothing 52 mm (2.0 in.)
- 4498:** for screw-on filter \varnothing 55 mm (2.2 in.)
- 4499:** for screw-on filter \varnothing 58 mm (2.3 in.)



4417
Gray Filter

For use in 4495 Filter Holder. Reduces light intensity by two aperture increments. Filter factor 4.

Dimensions: 67 x 67 mm (2.6 x 2.6 in.)



4448
Filter Drawer

For all Kaiser enlargers. For filter inserts size 8.5 x 8.5 cm (3.3 x 3.3 in.)

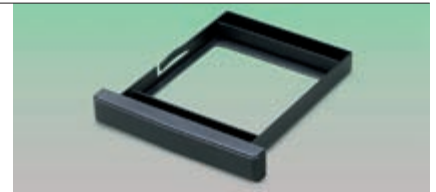

4437
Heat Filter

For the protection of negatives and acetate or gelatine filters in B & W enlargers against heat stress during continuous operation. Fits in suitable filter drawers.

Dimensions: approx. 70 x 70 mm
(2.8 x 2.8 in.)

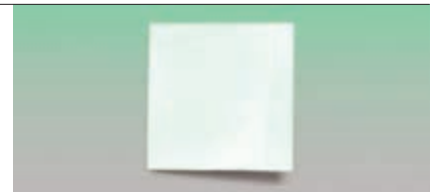



5979
Slide Copying Kit

Consists of holder and cover for the up-turned color head. Allows the use of any Kaiser colour head as light source for slide copying.



5976
4 x 5" Slide Copying Adapter

To duplicate slides up to 4 x 5" in conjunction with the 4544 Color Mixing Head (see page 222). The adapter is mounted on the turned over color mixing head. Supplied with adapter plate so that a Kaiser negative carrier can be positioned on the slide copying adapter.



4489
Negative Mask for 5 x 5 cm Slides

For mounted slides with outer dimensions 5 x 5 cm (2 x 2 in.). For insertion into 4583 Compound Negative Carrier.

Dimensions: 100 x 72.5 mm (3.9 x 2.9 in.)

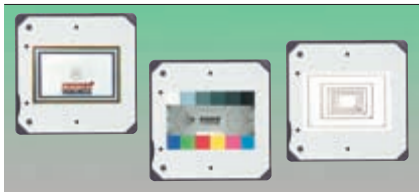

5969
Test Slides

For determining picture frame for copying 1:1. For determining correct exposure times for cropping and as an aid to establishing exposure, filtration and focus.

The set consists of 3 framed 35 mm slides.

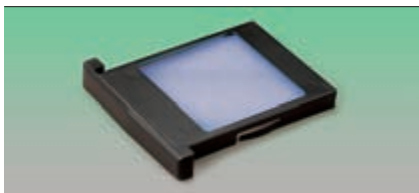

5974
Conversion Filter

To be exchanged with the filter drawer of the color head. Required if slide copying is done with daylight film.

Dimensions: approx. 8.5 x 8.5 cm (3.3 x 3.3 in.)

Tools for Picture-Makers

The enlarger is the most important device in the darkroom. But in addition there is a wide range of supplementary tools to make exposing photographic paper easier and more reliable. The basic equipment should at least comprise a safelight for a „safe“ basic illumination, a masking frame or easel for holding the photographic paper and a timer to control the exposure time.

Test printer and focus magnifier round off the equipment.

Developing the exposed photo paper requires lab trays (a minimum of three), print tongs, bottles for photo chemicals, graduates and beakers to measure and mix the chemicals, a process timer, a thermometer and a drying rack as basic equipment.

If you also want to do your own film developing, you will also need a developing tank with a self-loading reel, bottles, graduates and funnels for the photo chemicals, a thermometer, a

process timer, film clips to hang up wet films and a pair of scissors.

Some basic knowledge is indispensable – there are many useful books – and some exercise is also needed. For this you will need time. The reward for your efforts are pictures which in their own way are unique and which bear the distinctive hand of their „maker“.

4704-06 „promask“ Professional Masking Frame

Margin stop with preclamping device, format markings and sinkable grid pins for centered positioning of photo paper. Grid pins at standard hole intervals. Frame made of non-warping moulded aluminium. Scales in cm and inch. Pneumatic spring with end position damping. Raised frame stays open. Four sliding masking strips with fast adjustment and fine setting by friction drive, lockable. Border width adjustable from 2 to 45 mm (0.08 to 1.8 in.). Each strip is individually adjustable. Light grey base plate. Non-slip rubber feet.

4704: For formats up to 30 x 40 cm (12 x 16 in.) Dimensions: 630 x 70 x 515 mm (24.8 x 2.8 x 18.4 in.)

4705: For formats up to 40 x 50 cm (16 x 20 in.) Dimensions: 725 x 70 x 620 mm (28.5 x 2.8 x 24.4 in.)

4706: For formats up to 50 x 60 cm (20 x 24 in.) Dimensions: 830 x 70 x 718 mm (32.7 x 2.8 x 28.3)

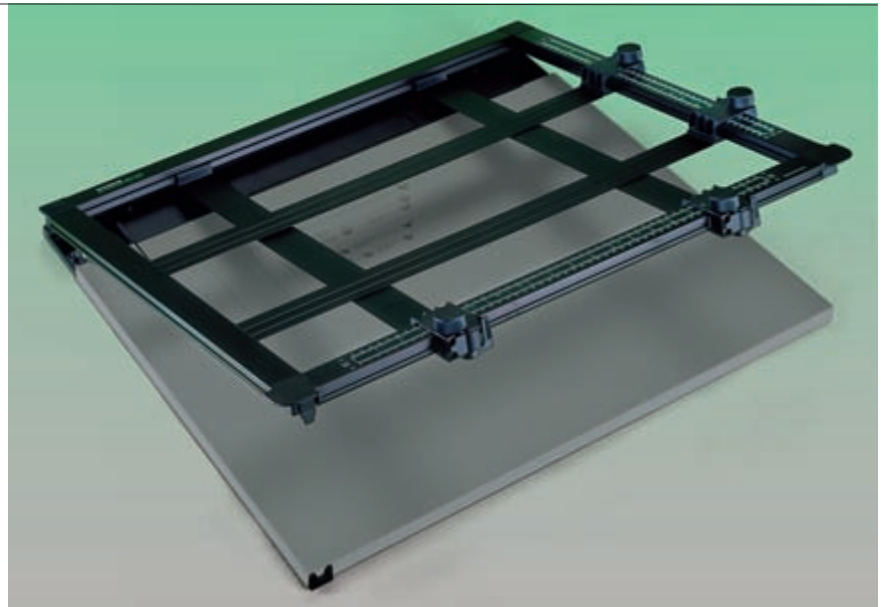

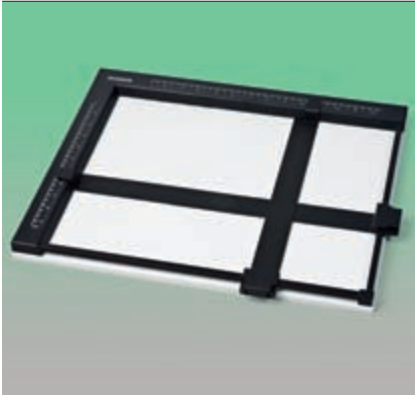

4001
Masking Frame
24 x 30 cm (9 1/2 x 12 in.)

Metal base plate with non-slip base and dull white surface. Adjustable margins for borders from 5 to 12 mm (0.2 to 0.5 in.). Metal dull black masking frame with cm and inch scales and snap paperholding mechanism. Bilaterally guided self-adjusting masking bands with instant-lock push buttons. Maximum print size 28 x 36 cm (11 x 14.2 in.).

Dimensions: (WxHxD): approx.
470 x 30 x 395 mm (18.5 x 1.2 x 15.6 in.)



4009
Test Printer

For producing test strips to determine exposure time and filter setting for enlargements. Top with six separately opened shutters. Turning the paper around after the first exposure makes a total of 12 exposures possible on one sheet of 13 x 18 cm (5 x 7 in.).

Dimensions: approx. 180 x 160 mm
(7.1 x 6.3 in.)



4005
„focuscop“ Focus Magnifier

For reliable focus control in enlarging. Double lens system with 4 x magnification. Focus control using both eyes. Bright, distortion-free image on focussing screen, wide viewing angle.

Dimensions (WxHxD): approx.
65 x 105 x 120 mm (2.6 x 4.1 x 4.7 in.)

6361
Antistatic Cloth

Lint-free, especially treated cloth.
Dimensions: approx. 24 x 30 cm
(9.4 x 11.8 in.)



6363
Special Antistatic Cloth

High-grade lint-free cloth with chainstitched border for cleaning and antistatic treatment of films, glass, and lenses. Also suitable for phonograph records, plastic parts and plastic-coated surfaces.
Dimensions: approx. 24 x 30 cm
(9.4 x 11.8 in.)



6308-10
„Clear Gear“ Compressed Air

For touch-free dust removal from optical, fine mechanical and electronic equipment and components.

6308: 200 ml, propane/butane mixture.

6309: 400 ml, non-inflammable fluorethane mixture.

6310: 400 ml, propane/butane mixture.



6362/65/67
Cotton Gloves

To prevent fingerprints on prints, negatives optical glass, etc. 100 % cotton, washable at all temperatures.

6362: One pair, size XL

6365: One pair, size L (standard size)

6367: Three pairs, size L



4065
Lab Apron

Acid-resistant and washable, made of light pleasant-to-wear material, with seamed edges. Matt black with pocket.

Length: approx. 1 m (40 in.)

Width: approx. 70 cm (28 in.)





4018 Darkroom Safelight



2008

Dull black plastic housing. Top tiltable from 0 to 40°. Can be used as wall or table-top light. Mounting on wall can be done either for direct or indirect lighting of working area. With 9 x 12 cm (3.5 x 4.7 in.) filter for Multigrade papers and graded B&W papers.

Lamp: 15 W, E 14
Cord with cord switch: approx. 1.8 m (6 ft.)
Dimensions: approx. 140 x 110 x 90 mm
(5.5 x 4.3 x 3.5 in.)

Supplied with lamp.

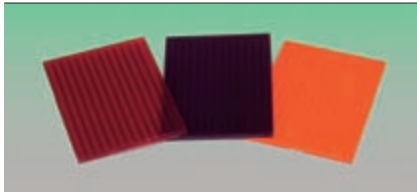

4013-15 Safelight Filter

Size 9 x 12 cm (3.5 x 4.7 in.), for 4018 darkroom safelight.

4013: Orange, for B&W silver chlorobromide papers.

4014: Red, for orthochromatic papers and films and B&W graded papers.

4015: Multigrade, for variable contrast papers and B&W graded papers.



4227 Darkroom Lamp

Red. 15 W, 230 V, E 27.
Can be used together with clamp-on lamp holder, for example.



4030 „digital timer“ Electronic Exposure Timer

2-digit amber-colored display. Time countdown to zero, then reset to starting time (can be repeated any number of times for exposure series). Interrupt and restart of remaining time, and interruption with direct reset to the set starting time are likewise possible. Focusing light switch.

Time range: 0.1 - 99 seconds
Display: 0.1 - 9.9 seconds in 10th sec. increments, and 10-99 seconds in sec. increments

Maximum switching capacity: 500 W

Dimensions: approx. 100 x 75 x 152 mm
(3.9 x 3 x 6 in.)

Power cable: 2 m (6 ft. 7 in.)

4218
Digital Lab Timer

Four-figure LCD display for minutes and seconds. Count-down. Time preset up to max. 99 minutes 59 seconds. Acoustic signal for count-down to zero. Interruption possible. Set starting time retrievable. Magnet on the back for simple fixing to metal surfaces. Including button battery: 1.5 V, type G-13.

Dimensions: approx. 88 x 14 x 46 mm
(3.5 x .6 x 1.8 in.)



4219
Process Timer

Three independent channels for separate timing, in addition clock, alarm and calendar functions. Time preset up to max. 99 hours, 59 minutes and 59 seconds. Acoustic signal for count-down to zero. Set starting times retrievable. Interruption possible. Counts upwards after count-down to zero. Various acoustic signals for simple identification of different channels. Holder clip for pocket or belt, folding stand foot and magnet for fixing to metal surfaces. Including button battery: 1.5 V, type G-13. Dimensions: approx. 82 x 15 x 70 mm (3.2 x .6 x 2.8 in.).



4092
„digi-thermo F“
Digital Thermometer

Battery-powered multi-purpose thermometer with four-digit LCD display, switchable from °C to °F. Fast response. Minimum and maximum temperature memory. Temperature alarm function with high and low limits. Actual value can be displayed permanently. Automatic cut-off. Stainless steel probe with 1 m (3 ft.) cord. Foldable stand.

Temperature range: -50°C ... +300°C
(-58°F ... +572°F)

Accuracy: ± 1°C (± 1.8 °F) in the range of -30°C ... +250°C (-22°F ... +482°F)

Battery: 1.5 V, G13 (or equivalent) included
Dimensions (w/o probe): 120 x 69 x 20 mm
(4.7 x 2.7 x 0.8 in.)



4026
Gradation Calculator

Calculator disk to determine the correct gradation.

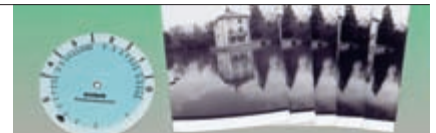



4080
Developing Tank Thermometer

Alcohol-filled. Unbreakable plastic stem.
With centigrade scale: -10 to 50° C.
With marker at 18° C.
Length: 130 mm (5.1 in.); ø 12 mm (.5 in.)



4081
Developing Tank Thermometer

Alcohol-filled. With centigrade and Fahrenheit scales: 0 to 50° C/32 to 120° F.
With marker at 18° C/64° F.
Length: 120 mm (4.7 in.), ø 11 mm (.4 in.)



4084
Floating Thermometer

With lead weight to ensure vertical position in the liquid and measurement under the surface. Alcohol-filled bulb. Centigrade and Fahrenheit scales: 0 ... 50° C/32 ... 120° F.
With marking at 18° C/64° F.
Length: 125 mm (4.9 in.), ø 11 mm (.4 in.)



4083
Tray Thermometer

With angled stem and hook for hanging it on tray's edge. Alcohol-filled bulb. Centigrade and Fahrenheit scales: 0 ... 50° C/32 ... 120° F.
With marking at 18° C/64° F. Length: 85 mm + 40 mm of angled stem (3.3 + 1.6 in.), ø 10 mm (.4 in.)



4086
Precision Thermometer

Especially suited for color processing. Alcohol-filled bulb. Luminous blue capillary. Scale from 10 to 50° C, calibrated in steps of .2 degrees, margin of error ± .2°. Max. immersion depth 60 mm (2.4 in.).
Length: 195 mm (7.7 in.), ø 12 mm (.5 in.)



4067
Print Tongs

Stainless steel, insensitive to photochemicals. With spiral spring and catch for hanging on side of tray. With protective caps especially designed for working with plastic-coated papers.
Length: 150 mm (6 in.) 2 pieces.



4062
Print Tongs

Made of chemical-resistant plastic; self-opening. Molded tray edge recess. One pair of different-coloured print tongs.
Length: 160 mm (6.3 in.)



4059
Print Tongs and Clamp

Print tongs made of chemical-resistant plastic, self-opening. Molded tray-edge recess. Can also be used as film or print clamp.
Length: 180 mm (7.1 in.) Set of two.

4151-78 Lab Trays

Made of shock-resistant plastic. Acid-proof. Heat resistant up to 80° C (176° F). Grooved bottom enhances removal of paper and ensures best possible flow for chemicals and stability. With pouring lip. 4171-73 with recess for tray thermometer.

For sizes up to	White	Black	Red	Dimensions (LxWxH): approx. mm/in.
13 x 18 cm / 5 x 7"	4151	4152	4153	235 x 185 x 50 / 9.3 x 7.3 x 2
20 x 25 cm / 8 x 10"	4156	4157	4158	325 x 260 x 65 / 12.8 x 10.2 x 2.6
24 x 30 cm / 9½ x 12"	4166	4167	4168	375 x 315 x 70 / 14.8 x 12.4 x 2.8
30 x 40 cm / 12 x 16"	4171	4172	4173	460 x 360 x 85 / 18.1 x 14.2 x 3.3
40 x 50 cm / 16 x 20"	4176		4178	580 x 490 x 95 / 22.8 x 19.3 x 3.7



4141 Dish Warmer

For one dish up to 30 x 40 cm (11.8 x 15.7 in.) or two dishes 20 x 25 cm (7.9 x 9.8 in.). All-metal housing in a black stoved-enamelled finish. Adjustable thermostat for automatic temperature control. ON/OFF switch and control light. Power cable: approx. 2 m (6 ft. 7 in.).

Heating capacity: 300 Watt
Control range: approx. 20 - 45°C (68 - 113 °F)
Tolerance: approx. ±0.5°
Dimensions (WxHxD): approx. 310 x 60 x 450 mm (12.2 x 2.4 x 17.7 in.)





4192-95
Chemical Storage Bottle

Made of polyethylene, unbreakable and acid-proof. With screw cap and blank label.

- 4192:** 1000 ml, white
- 4193:** 1000 ml, brown
- 4194:** 2000 ml, white
- 4195:** 2000 ml, black



4198-99
Accordion Bottle

For photochemicals. Black. The accordion-like walls can be pressed together, setting excess air free. This reduces the danger of oxidation and allows for longer storage of chemicals.

With screw-on cap.

- 4198:** 550-1000 ml
- 4199:** 900-2000 ml



4250-55
Graduate

Made of Chemical-resistant polypropylene. Temperature-resistant up to 95 °C (203 °F). With pouring lip and wide base for steady stand. Graduated scale.

	Content	Scale steps	Height mm/in.
4250:	50 ml	1 ml	150/6
4252:	100 ml	2 ml	160/6.3
4253:	250 ml	5 ml	195/7.7
4254:	500 ml	10 ml	220/8.7
4255:	1000 ml	20 ml	285/11.2



4256-57
Graduated Beaker

Made of chemical-resistant plastic. Temperature-resistant in excess of 80 °C (176 °F). With pouring lip and scale.

	Content	Scale steps	Height mm/in.
4256:	1000 ml	10 ml	150/5.9
4257:	2000 ml	20 ml	215/8.5

4243
Funnel

For handling photochemicals. Made of non-breakable chemical-resistant polyethylene. Ribbed barrel to prevent airlocks and facilitate fast pouring.
Diameter: 120 mm (4.7 in.)
Height: 170 mm (6.7 in.)

4296
„Standard“ Developing Tank

With adjustable self-winding reel for film size 135 (35 mm), 126, 127, 120 or 220 (roll film). Tank and reel made of nonbreakable plastic. Quick-drain outlet.

Capacity: one film size 135 (35 mm) or two films size 126 or two films size 127 or one film size 220 or two films size 120.

Max. quantity: 500 ml

Dimensions: ø 100 mm (3.9 in.), height approx. 160 mm (6.3 in.)

Additional reel 4298 available.



4298
Self-Winding Reel

For films size 135 (35 mm), 126, 127, 120 or 220. Fits 4296 and 4297 developing tanks.

4297
„Universal“ Developing Tank

With two adjustable self-winding reels. For film sizes 135 (35 mm), 126, 127, 120 or 220 (roll film). Tank and reels made of non-breakable plastic. Quick-drain outlet.

Capacity: two films size 135 (35 mm) or four films size 126 or two films size 127 or one film size 220 or two films size 120.

Max. quantity: 650 ml

Dimensions: ø 100 mm (3.9 in.), height approx. 160 mm (6.3 in.)



4263
Film Washing Hose

For fast and thorough film washing. Fits 4286-87, 4296-97 Kaiser developing tanks and almost all water faucets.

Length: approx. 55 cm (22 in.)





4299 Negative Lab Set

Contains all items required for B & W developing.

- Includes: Film wiper (4070),
- Tank thermometer (4081),
- Film clips (4117),
- Chemical storage bottle 1000 ml, white (4192),
- Chemical storage bottle 1000 ml, brown (4193),
- Funnel \varnothing 120 mm (4243),
- Graduate 250 ml (4253),
- „Standard“ developing tank (4296)



4094 PE/RC Print Washer

For quick and thorough washing of plastic-coated papers. With connecting hose of 1 m (3.3 ft.) length and hose clip for attaching to water outlet.

For formats up to 30 x 40 cm (12 x 16 in.)
Capacity: approx. 4 l
Dimensions (WxHxD): approx. 460 x 85 x 360 mm (18.1 x 3.3 x 14.2 in.)

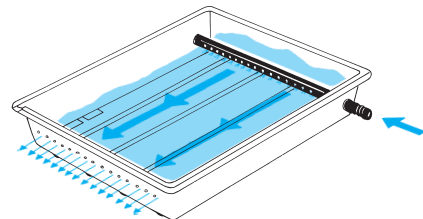

4048
Drying Rack

For air-drying of plastic-coated paper (PE/RC papers). For five 30 x 40 cm (12 x 16 in.) or 24 x 30 cm (9 1/2 x 12 in.) prints or ten 20 x 25 cm (8 x 10 in.) prints or more prints of smaller size.

Required space: approx. 32 x 22.5 cm
(12.6 x 8.9 in.)

Height: approx. 25 cm (9.8 in.)



4056
Roller Squeegee

For squeezing off excess water from plastic-coated papers. Also suitable for blister-free rolling of prints on glazing pressures and for mounting photographs on particle boards etc. Handy plastic handle. Roller made of moulded PVC, 180 mm (7.1 in.) wide, ø 26 mm (1 in.).

Dimensions: approx. 190 x 50 x 140 mm
(7.5 x 2 x 5.5 in.)

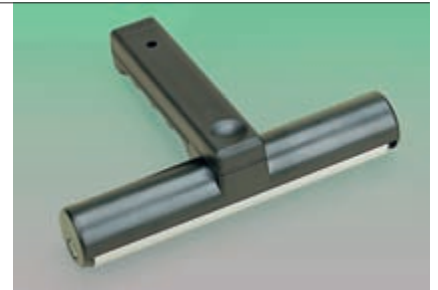

4070
Film Wiper

With four-fold soft rubber blades, 70 mm (2.8 in.) wide. Completely harmless to film. For film widths up to 60 mm (2.4 in.).

Length: 160 mm (6.3 in.)



4117
Film Clips

For hanging up wet films. 3-hole clip mechanism. Plastic with stainless steel spring. 1 clip with and 1 without weight.

Dimensions: approx. 27 x 83 x 14 mm
(1.1 x 3.3 x .6 in.)



4120
Film Clips

For hanging up wet films. 2-hole clip mechanism. Stainless steel model.

1 clip with and 1 without weight.





4129
Film Loader

For loading bulk 35 mm film into cartridges in daylight. For bulk film material up to 30 m (98 ft.). With frame counter and remaining-film meter.

Dimensions: approx. 130 x 110 x 80 mm
(5.1 x 4.3 x 3.1 in.)



4127
Film Cartridges

For 35 mm film. For self-loading with bulk film material. Plastic type, 5 pcs.



4132
Film Leader Retriever

For extracting 35 mm film leader from cartridges into which the film has been wound. Plastic casing with one fixed and one sliding tongue. Simple use.



4125
Film Cartridge Opener

For opening 35 mm film cartridges.

Dimensions: approx. 140 x 40 x 40 mm
(5.5 x 1.6 x 1.6 in.)



6689
Antismagnetic Lab Scissors

Made of fibreglass-reinforced nylon. Blades of special heat-treated stainless steel, antismagnetic.

Length: 18 cm (7.1 in.)

Lamp Chart

Product code no.	Designation	Page	Number of required lamps	Replacement lamp(s) code no.	(Additional) Suitable lamp(s) code no.	Page
2003	"diascop 1" Slide Viewer	131	1	2107		129, 131, 132
2005	"diascop 3" Slide Viewer	131	1	2107		129, 131, 132
2006	"diascop 4" Slide Viewer	131	1	2008		131, 132, 232
2010	"diascop mini 3" Slide Viewer	132	1	2107		129, 131, 132
2011	"diascop mini 2" Slide Viewer	132	1	2107		129, 131, 132
2015	"diascop 50 N" Slide Viewer	132	1	2008		131, 132, 232
2115	"diacut 1" Slide Cutter	130	1	2109		130
2167	"diamount C.A.M./CS" Slide Cutter and Mounter	129	1	2107		129, 131, 132
2339	Pocket Microscope	127	1	2336		127
2403	"prolite basic 2" Light Box	120	2	2146, 2474 ¹⁾		89, 120
2405	"prolite basic 2" Light Box	16, 120	2	2136, 2476 ¹⁾		89, 120
2406	"prolite basic 2" Light Box	120	4	2136, 2477 ²⁾		89, 120
2423	"prolite basic 2 HF" Light Box	120	2	2146, 2474 ¹⁾		89, 120
2425	"prolite basic 2 HF" Light Box	16, 120	2	2136, 2476 ¹⁾		89, 120
2426	"prolite basic 2 HF" Light Box	120	4	2136, 2477 ²⁾		89, 120
2433	"prolite basic 2 HF", Light Box, dimmable	120	2	2146, 2474 ¹⁾		89, 120
2435	"prolite basic 2 HF", Light Box, dimmable	120	2	2136, 2476 ¹⁾		89, 120
2436	"prolite basic 2 HF", Light Box, dimmable	120	4	2136, 2477 ²⁾		89, 120
2441	"prolite 5000 HIQ" Light Box	122	4	2136, 2477 ²⁾		89, 120
2492	"prolite scan SC" Light Box	121	4	2414, 2487 ²⁾		89, 121
2493	"prolite scan SC" Light Box, dimmable	121	4	2414, 2487 ²⁾		89, 121
3047	300 W Portable Lighting Kit	46	1	3058	3038	47, 90
3049	1000 W Portable Lighting Kit	46	1	3075	3038, 3051, 3058, 3094	47, 90
3102	Clamp-on Lamp Holder	48	1		3128	47, 90, 103
3120	Clamp-on Lamp Holder	48	1		3128	47, 90, 103
3140	Studio Light	41	1		3110, 3124, 3128, 3130, 4356	19, 47, 99, 223
3150	"studiolight C" Lighting Unit	39	1	3124	3125-3130	47, 90, 99, 103
3154	"studiolight C Kit" Lighting Kit	36	2	3124	3125-3130	47, 90, 99, 103
3156	"studiolight C Trio" Lighting Kit	36	3	3124	3125-3130	47, 90, 99, 103
3157	"studiolight H Trio" Lighting Kit	35	3	3075	3038, 3051, 3058, 3094	47, 90
3164	"studiolight 1010" Lighting Unit	38	1	3075	3038, 3051, 3058, 3094	47, 90
3165	"studiolight 1010 Kit" Lighting Kit	34	2	3075	3038, 3051, 3058, 3094	47, 90
3168	"studiolight 510 Kit" Lighting Kit	37	2	3124	3125-3130	47, 90, 99, 103
3288	"camlight Nova" Video Light	29	1	3027		47
3425	"proVision 2.55 HF" Soft Light	42	2	3454	3464	42, 47, 89
3428	"proVision 4.55 HF" Soft Light	42	4	3454	3464	42, 47, 89
3431	"proVision 6.55 HF" Soft Light	42	6	3454	3464	42, 47, 89
4018	Darkroom Safelight	232	1	2008		131, 132, 232
4401	VP 350 B & W Enlarger	219	1	4356		90, 99, 223
4420	VCP 3505 Color Enlarger	213	1	4459		223

¹⁾ 2 lamp pack

²⁾ 4 lamp pack

Product code no.	Designation	Page	Number of required lamps	Replacement lamp(s) code no.	(Additional) Suitable lamp(s) code no.	Page
4425	VP 3505 B & W Enlarger	217	1	4356		90, 99, 223
4426	VPM 3505 Multigrade® Enlarger	215	1	4459		223
4460	VCP 6005 Color Enlarger	213	1	4459		223
4465	VP 6005 B & W Enlarger	217	1	4356		90, 99, 223
4470	VP 7005 B & W Enlarger	217	1	4356		90, 99, 223
4471	VPM 7005 Multigrade® Enlarger	215	1	4459		223
4480	VCP 7005 Color Enlarger	213	1	4459		223
4530	VPM 6005 Multigrade® Enlarger	215	1	4459		223
4540	VP 9005 B & W Enlarger	217	1	4356		90, 99, 223
4541	B & W Head	222	1	4356		90, 99, 223
4544	Color Head	222	1	4459		223
4545	Multigrade® Head	222	1	4459		223
4550	VCP 9005 Color Enlarger	213	1	4459		223
4560	VPM 9005 Multigrade® Enlarger	215	1	4459		223
5205	Copylizer eVision ini.tial	82	4	2146, 2475 ²⁾		89
5206	Copylizer eVision ini.tial HF	82	4	2146, 2475 ²⁾		89
5211	Copylizer eVision exe.cutive	79	4	2136, 2477 ²⁾		89
5212	Copylizer eVision exe.cutive HF	79	4	2136, 2477 ²⁾		89
5232	Copylizer eVision exe.cutive HF, dimmable	79	4	2136, 2477 ²⁾		89
5241	Illumina Base	81	4	2136, 2477 ²⁾		89
5242	Illumina Base HF	81	4	2136, 2477 ²⁾		89
5262	Illumina Base HF, dimmable	81	4	2136, 2477 ²⁾		89
5267	RB 2.18N HF Copylizer Lighting Unit	82	2	5458		89, 100
5270	RB 2.36 Copylizer Lighting Unit	80	2	5567		89
5276	RB 4.36 HF Copylizer Lighting Unit	80	4	5567		89
5277	RB 4.36 HF Copylizer Lighting Unit, dimmable	80	4	5567		89
5280	RB 4.55 HF Copylizer Lighting Unit	80	4	3454		42, 47, 89
5281	RB 4.55 HF Copylizer Lighting Unit, dimmable	80	4	3454		42, 47, 89
5304	R2N CP Image Capturing Set	101	2	5458		89, 100
5360	"reprokid" Camera Stand	103	2		3128	47, 90, 103
5450	RB 2 Lighting Unit	99	4		3124, 4356	47, 90, 99, 223
5464	RB 218N HF Lighting Unit	15, 100	2	5458		89, 100
5552	RB 300 Lighting Unit	90	2	3038	3058	47, 90
5554	RB 104 Lighting Unit	90	4		3124, 3128, 3130, 4356	47, 90, 99, 223
5556	RB 5000 DL Lighting Unit	88	2	5567		89
5557	RB 5004 Lighting Unit	88	4	5567		89
5558	RB 5004 HF Lighting Unit	88	4	5567		89
5563	RB 3 Lamp Fixtures	91	2		3128	47, 90, 103
5588	RB 5004 HF Lighting Unit, dimmable	88	4	5567		89
5589	RB 5055 HF Lighting Unit, dimmable	87	4	3454		42, 47, 89

²⁾ 4 lamp pack

Product code no.	Designation	Page	Number of required lamps	Replacement lamp(s) code no.	(Additional) Suitable lamp(s) code no.	Page
5590	RB 5055 HF Lighting Unit	87	4	3454		42, 47, 89
5591	RB 5003 UV Lighting Unit	87	6	5569		87
5595	RB 5003 UV-HF Lighting Unit	87	6	5569		87
5617	Trans-Illuminator	71	4	2414, 2487 ²⁾		89
5656	RB 5056 HF Lighting Unit	72	4	3454		42, 47, 89
5657	RB 5056 HF Lighting Unit, dimmable	72	4	3454		42, 47, 89
5860	Lamp Holder	19, 41	1	3128		47, 90, 103
5861	Desktop Lighting Kit 1	19	1	3110	3124, 3128, 3130, 4356	19, 47, 99, 223
5862	Desktop Lighting Kit 2	19	2	3110	3124, 3128, 3130, 4356	19, 47, 99, 223
5863	Desktop Shooting Kit + Cube Studio 50 x 50 x 50 cm	17	2	3110	3124, 3128, 3130, 4356	19, 47, 99, 223
5864	Desktop Shooting Kit + Cube Studio 90 x 90 x 90 cm	17	2	3110	3124, 3128, 3130, 4356	19, 47, 99, 223
5867	Reflected Light Illuminating Set	11	4	5567		89
5868	Transmitted Light Illuminating Set	11	4	5567		89
5884	Lighting Module	18	1	5567		89
5914	Studio-out-of-the-Box Lighting Set	21	2	5909	2133	21
5941	Light Source	51	1	5952		51
5945	"macrospot 1500" Fiber-Optic Lighting System	50	1	5952		51
5960	20 W Halogen Light	49	1	5966	5981, 5987	49
5965	50 W Halogen Light	49	1	5968	5966-67, 5981-83, 5987-89	49
5993	Table-Top-Studio digital SN-HF	13	2	5458		89, 100
5994	Table-Top-Studio digital SN-HF plus	13	2	5458		89, 100
93304	"videolight 6" Safety Ligthing Unit	44	1	3075	3038, 3051, 3058, 3094	47, 90
93307	"videolight 8S" Safety Lighting Unit	45	1	3058	3038	47, 90
93310/39	"camlight 100" Video Light	30	1	3054	3028	47
93325	"videolight 4" Safety Ligthing Unit	44	2	3075	3038, 3051, 3058, 3094	47, 90
93392	"videolight 150" Safety Lighting Unit	45	1	3003		47

²⁾ 4 lamp pack

Index

- Accessory brackets** 29, 170, 182
Accessory shoe adapter 181
Accessory shoes 180
Accordion bottles 236
Acrylic glass cleaner 22, 203
Acrylic glass plate 10
Acrylic glass polish 22, 203
Adapter
- Accessory shoe 181
- Cable release 159
- Clamp 62
- Close-up 71
- Copy 219
- Filter 154, 186, 196
- Flash 181
- Flash shoe 181
- Flash socket 179
- for filter holder 227
- for TopTable PRO 10
- rePRO 71
- Screw and thread 62, 170
- Thread 62, 170
- T-mount 154
Adapter rings, for filters 154, 196
Add-on tables 10, 14
Adhesive paste 22
Air duster 22, 199, 231
Alfi slide mounts 130
AN glass inserts 219, 225
Angle brackets 182
Antimagnetic scissors 125, 240
Antistatic brushes 205
Antistatic cloths 201, 205, 231
Antistatic film cleaners 206
Antistatic gloves 205
Apron 231
Artificial light panel 26

B&W enlargers 214-217, 219
B&W heads 222
Background cardboard holder 56
Background carrier 11
Background "Concave" 18
Background reflector 40
Bags 164, 165
Ball heads 168, 169

Base boards
- for camera stands 72, 92, 97
- for enlargers 220
Base for flexible arm 59
Base magnifiers 126, 127
Base plate, for vertical stand 97
Base stands
- for camera stands 71, 77, 85
- for enlargers 220
- for shooting table 14
Basic support 10
Battery box 184
Battery, for video light 30
Binocular mounts 170
Blower bellows 199
Blower brushes 200
Book cradle 106
Book holder 105
Bottles 236
Bounce flash shoes 180
Bracket screws 170
Brackets
- Accessory 29, 170, 182
- Angle 182
- Flash 182
- Hinged 59, 97
Brushes 200, 205

Cable release adapters 159
Cable releases 156-159
Cables 158, 178
Calibration tool 183
Camcorder lights 26-30
Camera accessories 143-186
Camera arms 94, 95, 105
Camera bags 164, 165
Camera body caps 153
Camera clamp 16, 58
Camera lights 26-31
Camera stands 66-68, 71, 73, 74, 76,
79, 82, 84-86, 97, 99, 101, 103
Camera straps 160, 161
Camera tripods 166, 167
Carrying cases, for lights 34, 39
CD pens 125
Changing bags 184
Charger 30

Chemical storage bottles 236
Circular polarizers 189, 192-195
Clamp adapter 62
Clamp base 80
Clamp-on lamp holder 48
Clamp-on lights 48
Clamps
- Camera 16, 58
- Double 62
- Flash 61, 179
- Holding 62
- Print 234
- Table 57, 61, 179
- Universal 57, 58
Cleaning accessories 197-206
Cleaning cloths
- Antistatic 201, 205, 231
- Leather 201
- Micro fibre 201, 205
Cleaning paper 200
Cleaning sets 202, 204, 206
Close-up adapter 71
Close-up lenses 190, 192-193
Cloths
- Antistatic 201, 205, 231
- Leather 201
- Micro fibre 201, 205
Cold light mirror lamps 51, 223
Cold light sources 50, 51
Color enlargers 212, 213
Color filter set, for macrospot 50
Color head 222
Color reference card 183
Column base 92
Columns 71, 76, 93, 97, 220
Compound negative carriers 224
Compressed air can 22, 199, 231
Concave background 18
Condensers 223
Contact cleaner 203
Conversion filters
- for enlargers 228
- for macrospot 50
- for video lights 30, 44, 45
Copy adapter 219
Copy arms 94, 95, 105

Copy lighting units 66, 67, 69, 72, 77, 80, 82, 87, 88, 90, 91, 99, 100, 101, 103
 Copy plate 107
 Copy stands 66-68, 71, 73, 74, 76, 79, 82, 84-86, 97, 99, 101, 103
 Copying accessories 63-108, 155
 Copylizer system 78-82
 Cords 178
 Cotton gloves 125, 203, 231
 Counter displays
 - with labelling pens 125
 - with magnifiers 126, 127
 - with micro fibre cleaning cloths 201
 - with optical-glass cleaning paper 200
 - with slide viewers 132
 - with table tripods 171
 CS slide trays 134, 135
 Cube Studio 17

Darkroom lamp 232
 Darkroom safelight 232
 DC voltage mains adapter 121
 Desktop light stands 19, 56
 Desktop lighting kits 19
 Desktop shooting kits 17
 Developing tank thermometers 234
 Developing tanks 237
 Diffusing foil 16, 43
 Diffusion screens 11, 43, 72, 89
 Digital lab timer 233
 Digital levels 108, 174
 Digital slide duplicator 155
 Digital thermometer 233
 Dish warmer 235
 Display & optics cleaning kits 202, 204, 206
 Document stage 107
 Dome Studio 18
 Double clamp 62
 Double condensers 223
 Drying rack 239

Easels 229, 230
 Electronic exposure timer 232
 Energy saving lamp 19, 47, 90
 Enlarger components 218-228
 Enlarger head lower part 221
 Enlarger surveys 211, 218

Enlargers 212-217, 219
 Enlarging lenses 226
 Exposure timer 232
 Extension arm 92, 221
 Extension cables/cords 158, 178
 Extraneous light protector 91

Fibre optic lighting system 50, 51
 Filing binder 133
 Film cartridge opener 185, 240
 Film cartridges 185, 240
 Film cleaners 206
 Film clips 239
 Film leader retriever 185, 240
 Film loader 185, 240
 Film strip carrier 155
 Film washing hose 237
 Film wiper 239
 Filter adapter 186
 Filter adapter rings 154, 196
 Filter drawer 227
 Filter holders
 - for enlargers 227
 - for lighting units 11, 72, 89
 Filters
 - for cameras 187-195
 - for cold light sources 50
 - for color head 228
 - for copy lighting units 72, 89
 - for darkroom safelight 232
 - for enlargers 227
 - for shooting table lighting units 11
 - for video lights 30, 44, 45
 Flash accessories 176-182
 Flash adapters 181
 Flash brackets 182
 Flash cables 178
 Flash clamp 61, 179
 Flash releases 176, 177, 180
 Flash shoe adapters 181
 Flash shoes 180
 Flash socket 179
 Flash socket adapter 179
 Flash triggers 176, 177, 180
 Flash/light fixtures 91
 Flexible arm 58
 Floating thermometer 234

Fluorescent lamps 21, 42, 47, 87, 89, 100, 120
 Focus attachment 50
 Focus magnifier 230
 Focusing stages 95, 99, 170
 Folding magnifier 126
 Format masks 225
 4x5" slide copying adapter 228
 Funnel 236

Glare shields 146, 147
 Glass add-on table 14
 Glass inserts 219, 225
 Gloves
 - Antistatic 205
 - Cotton 125, 203, 231
 - Photo functional 163
 Gradation calculator 233
 Graduated beakers 236
 Graduates 236
 Gray filters 190, 192-195, 227
 Grey card 183
 Guillotine cutters 140, 142

Halogen cold light mirror lamps 51, 223
 Halogen lamps 47, 49, 51, 90, 223
 Halogen lights 29, 30, 34, 35, 38, 44-46, 49
 Hand grip 163
 Hand-held magnifiers 126
 Handheld tripods 172, 173
 Hard shell camera bags 164
 Heads, for enlargers 222
 Heat filter 227
 Hinged brackets 59, 97
 Holding clamp 62
 Holding frame 14

Illumina bases 81
 Illuminated magnifiers 126
 Image capturing set 101
 Inserts 225
 Inspection loupe 127
 Interchangeable reflectors 40
 IR flash trigger 176, 177
 IR remote control, for light 27
 IR remote releases 156
 Iris diaphragm 50

Joint with umbrella mount 59

Kinetrronics cleaning accessories 204-206

Lab accessories 207-240

Lab apron 231

Lab scissors 240

Lab timer 233

Lab trays 235

Labelling pens 125

Lamp arms 91

Lamp chart 241-243

Lamp fixtures 91

Lamp holders 19, 41, 48

Lamps

- Darkroom 232

- Energy saving 19, 47, 90

- Fluorescent 21, 42, 47, 87, 89, 100, 120

- Halogen 47, 49, 51, 90, 223

- Halogen cold light mirror 51, 223

- Opal 47, 90, 99, 223

- Photofloods 47, 90

- Reflector 47, 90, 103

- Replacement 127, 129-132, 232

- UV-A fluorescent 87

Laser light pointer 136

LCD accessories 145-149

LCD screen glare shields 146, 147

LCD screen protecting films 148, 149

LCD viewfinder 145

Leather bags 164

Leather cleaning cloth 201

LED camera lights 26-28, 31

LED light boxes 118, 119

Lens accessories 150-155

Lens brushes 200

Lens cap keeper 152

Lens caps 152

Lens holder rings 226

Lens hoods 150, 151

Lens rear caps 153

Lenses

- for enlargers 226

- for scanner cameras 114

Light boxes 16, 115-122

Light fixtures 91

Light guides 51

Light pointer 136

Light source 51

Light stands 19, 53-56

Light tents 17, 18

Lighting kits 19, 34-37, 46

Lights

- Camcorder 26-30

- Camera 26-31

- Clamp-on 48

- Copy 66, 67, 69, 72, 77, 80, 82, 87, 88, 90, 91, 99, 100, 101, 103

- Copylizer 80, 82

- Darkroom 232

- Fibre optic 50, 51

- for shooting tables 11, 15, 18, 19, 21

- Halogen 29, 30, 34, 35, 38, 44-46, 49

- LED camera 26-28, 31

- Ring 31

- Safety 34, 35, 38, 44-46

- Soft 42

- Studio 34-39, 41, 42, 44-46

- Video 26-30, 34-39, 42, 44-46

Macro spot 50, 51

Magic arms 59, 97

Magnifiers 126, 127

Mains adapter

- DC voltage 121

- for flash trigger 177

- for light boxes 118

- for lights 27, 28

- for slide equipment 129, 131

Masking frames 229, 230

Masks 225, 228

Matt spray 22

Memory card boxes 184

Metal plates 73, 81, 82, 97

Micro fibre cloths 201, 205

Monitor glare shields 146, 147

Monopods 167, 172

Mounting accessories 57-59, 61, 62

Mounting adapter 10

Mounting foot 62

Mounting rod 61

Mounting shoes 180

Multigrade® enlargers 214, 215

Multigrade® head 222

Neck chain 161

Negative filing sheets 133

Negative lab set 238

Negative masks 228

Neutral density filters 190, 192-195, 227

Opal lamps 47, 90, 99, 223

Optical light guides 51

Optical-glass cleaning paper 200

Optics cleaning kits 202, 204, 206

Orange filters 191, 194-195

PE/RC print washer 238

Pens, Labelling/CD 125

Photo functional gloves 163

Photofloods 47, 90

Plastic polish 22, 203

Pneumatic remote releases 159

Pocket magnifier 126

Pocket microscope 127

Pocket tripod 171

Polarisation filters 11, 50, 72, 89, 189, 192-195

Portable lighting kits 34-37, 46

Pouches 164, 165

Power pack, for video light 30

Precision thermometer 234

Pressure plate 81

Print clamps 234

Print tongs 234

Print washer PE/RC 238

Process timer 233

Quick release plates 168, 169

Quick-release connector 169

R1 system 83-95

R2 system 98-101

Radio and IR flash trigger 176, 177

Radio-controlled remote releases 157

RD system 75-77

Red filters 191, 194-195

Reflected light illuminating set 11

Reflection shields 108

Reflector lamps 47, 90, 103

Reflector umbrellas 60, 61

Reflectors 40

- Remote control, for light 27
 Remote flash triggers 176, 177, 180
 Remote releases . . . 156-159, 176, 177, 180
 Replacement lamps . . . 127, 129-132, 232
 → see also "Lamps"
 rePRO adapter 71
 repro kid 102-103
 Repro scanner 109-113
 rePRO system 70-74
 Reversible thread pin 62
 Right angle male plug 179
 Ring light attachment 51
 Ring lights 31
 Rodenstock enlarging lenses 226
 Rodenstock filters 194, 195
 Roller squeezegee 239
- Safelight filters** 232
 Safelight, for darkroom 232
 Safety lights 34, 35, 38, 44-46
 Safety trimmers 139-142
 Scanning cameras 109-113
 Schneider lenses 114, 226
 Scissors 125, 240
 Screen protecting film 148, 149
 Screw and thread adapters 62, 170
 Screw-in spirit level 175
 Screw-on filter adapter 227
 Screws 170
 Self-winding reel 237
 Sheet steel plate 73
 Shooting tables . . . 5-10, 12-14, 18, 20-21
 Shoulder pod 163
 Shoulder straps 160, 161
 Shutter releases 156-159
 Skylight filters 188, 194, 195
 Slide accessories 129-136
 Slide archive 135
 Slide cases 135
 Slide copying adapter 4x5" 228
 Slide copying kit 228
 Slide cutter and mounter 129
 Slide cutters 129, 130
 Slide duplicator 155
 Slide magazines 134, 135
 Slide mounts 129, 130
 Slide sleeves 133
- Slide storage pages 133
 Slide trays 134, 135
 Slide viewers 131-132
 Slide-out magnifier 126
 Small product table 14
 Snap-on lens caps 152
 Soft boxes 40
 Soft light sources 16
 Soft lights 42
 Soft screens 43
 Sony/Minolta accessory shoe adapter . . 181
 SpeckGRABBER 204
 Spiral cords 178
 Spirit levels 108, 174, 175
 Stands
 - Copy 66-68, 71, 73, 74, 76, 79, 82,
 84-86, 97, 99, 101, 103
 - Light 19, 53-56
 - Table 186
 → see also "Tripods"
 Straps 160, 161
 Studio lights 34-39, 41, 42, 44-46
 Studio stands 53-55
 Studio umbrellas 60, 61
 Studio-out-of-the-Box 20, 21
 Swivel joint 170
 SYSTEM-V, surveys 210, 211, 218
- Table clamps** 57, 61, 179
 Table
 - for book cradle 106
 - for copying works 74
 Table frame 71
 Table stand 186
 Table tripods 171
 Table-Top-Studio "digital" 13
 Test printer 230
 Test slides 228
 Thermometers 233, 234
 Thread adapters 62, 170
 Thread pin 62
 Tiltall 166-168
 Timers 232, 233
 Titling arm 94
 T-mount adapters 154
 TopTable 12-16
 TopTable lighting units 15
- TopTable RRO 8-11
 Transformers, for enlargers 223
 Trans-illuminator 71
 Transmitted light illuminating set 11
 Tray thermometer 234
 Trimmers 137-142
 Triple PC flash outlet 179
 Tripods 166, 167, 171-173
 Trolley, for lights 39
 Twin1 remote releases 156, 157
 TwinLink flash trigger 176, 177
- Umbrella mounting rod** 61
 Umbrellas 60, 61
 Universal clamps 57, 58
 Universal slide trays 134, 135
 UV filters 188, 192-195
 UV-A fluorescent lamp 87
 UV/IR blocking filters 189, 194, 195
- Vertical stand** 96, 97
 Video lights 26-30, 34-39, 42, 44-46
 Video shoulder pod 163
 Video transfer 186
 Viewfinder 145
- Wall mounts** 72, 77, 93, 221
 White balance filters 153, 183
 Wired remote switch 158
 Wireless remote releases 156, 157
 Wooden base plate 10
 Wrist straps 162
- Xerapol** 22, 203
- Yellow filters** 191, 194-195
- Zeiss lenses** 114

Number Index

The following list contains all products in numerical order and the page number in the catalogue where they are described.

Code No.	Page	Code No.	Page	Code No.	Page	Code No.	Page	Code No.	Page	Code No.	Page	Code No.	Page	Code No.	Page
1000	182	2012	132	2406	120	3038	47, 90	3178	40	4056	239	4195	236	4350	114, 226
1100	182	2015	132	2414	89	3042	60	3195	54	4059	234	4198	236	4355	226
1107	182	2035	125	2419	118	3043	60	3196	54	4062	234	4199	236	4356	90, 99,
1108	29, 182	2039	125	2423	120	3047	46	3248	31	4065	231	4218	233		223
1200	180	2040	125	2425	16, 120	3049	46	3250	31	4067	234	4219	233	4360	226
1201	180	2041	125	2426	120	3051	47	3255	27	4070	239	4227	232	4363	226
1211	180	2107	129, 131,	2433	120	3054	47	3256	27	4080	234	4243	236	4365	226
1215	181		132	2435	120	3058	47, 90	3260	26	4081	234	4250	236	4367	226
1216	180	2109	130	2436	120	3075	47	3261	26	4083	234	4252	236	4382	226
1300	181	2115	130	2441	122	3080	60	3263	27	4084	234	4253	236	4384	226
1301	181	2133	21	2447	118	3081	60	3270	28	4086	234	4254	236	4401	219
1303	181	2136	89	2448	118	3084	61	3271	28	4092	233	4255	236	4403	219
1304	181	2146	89	2449	118	3094	47	3272	163	4094	238	4256	236	4405	97
1311	179	2156	129	2450	119	3102	48	3273	170	4103	140	4257	236	4406	97
1313	179	2157	129	2451	119	3110	19, 47, 90	3288	29	4117	239	4263	237	4408	93, 220
1322	179	2167	129	2452	119	3120	48	3413	43	4120	239	4296	237	4409	93, 220
1326	179	2204	134	2474	120	3124	47, 90, 99	3414	43	4125	185, 240	4297	237	4412	93, 221
1405	178	2206	135	2475	89	3125	47	3415	43	4127	185, 240	4298	237	4413	220
1407	178	2207	134	2476	120	3126	47	3416	43	4129	185, 240	4299	238	4414	220
1408	178	2213	134	2477	89	3128	47, 90,	3417	43	4132	185, 240	4301	142	4417	227
1409	178	2217	134	2487	89		103	3418	43	4141	235	4303	140	4420	213
1420	178	2218	135	2492	121	3129	47	3420	55	4151	235	4306	140	4421	71
1423	178	2219	135	2493	121	3130	47, 90	3425	42	4152	235	4307	140	4423	226
1424	178	2316	136	2500	133	3140	41	3428	42	4153	235	4313	139	4424	226
1425	178	2332	127	2510	133	3150	39	3431	42	4156	235	4314	139	4425	217
1426	178	2333	126	2513	133	3154	36	3439	16, 43	4157	235	4317	141	4426	215
1503	180	2334	127	2515	133	3156	36	3454	42, 47, 89	4158	235	4318	141	4427	92
1504	180	2336	127	2516	133	3157	35	3464	42, 47	4166	235	4319	141	4431	225
1512	61, 179	2338	126	2530	133	3159	40	4001	230	4167	235	4323	142	4432	225
1522	61	2339	127	2535	133	3160	40	4005	230	4168	235	4324	142	4433	225
2003	131	2353	127	2580	133	3162	39	4009	230	4171	235	4327	226	4434	225
2005	131	2368	126	2590	133	3163	39	4013	232	4172	235	4329	226	4435	225
2006	131	2369	126	2610	133	3164	38	4014	232	4173	235	4336	226	4436	225
2008	131, 132,	2370	126	2630	133	3165	34	4015	232	4176	235	4337	226	4437	227
	232	2372	126	3002	44	3166	34	4018	232	4178	235	4338	226	4443	223
2009	129, 131	2395	121	3003	47	3168	37	4026	233	4192	236	4340	226	4448	227
2010	132	2403	120	3027	47	3170	40	4030	232	4193	236	4341	226	4449	223
2011	132	2405	16, 120	3028	47	3177	40	4048	239	4194	236	4349	226	4451	223

Code No.	Page	Code No.	Page	Code No.	Page	Code No.	Page	Code No.	Page	Code No.	Page	Code No.	Page
4453	223	5004	171	5294	81	5571	91	5891	18	5976	228	6068	166, 167
4455	92, 221	5023	57	5298	82	5582	11, 89	5892	18	5979	228	6069	166, 167
4459	223	5027	57	5301	101	5583	11, 89	5893	17	5981	49	6070	166, 167
4460	213	5028	57	5304	101	5588	88	5894	17	5982	49	6071	166, 167
4465	217	5029	62	5360	103	5589	87	5901	107	5983	49	6074	146
4469	226	5031	53	5361	103	5590	87	5903	107	5987	49	6075	147
4470	217	5033	53	5411	99	5591	87	5904	105	5988	49	6076	148
4471	215	5035	53	5421	219	5592	72, 89	5907	108	5989	49	6078	148
4472	220	5039	58	5450	99	5593	72, 89	5908	108	5993	13	6079	148
4473	93, 220	5040	59, 97	5458	89, 100	5594	11, 72, 89	5909	21	5994	13	6080	148
4474	93, 220	5041	59	5464	15, 100	5595	87	5911	21	5995	13	6081	148
4475	93, 220	5043	57	5465	15, 100	5602	76	5914	21	5996	13	6082	148
4476	93, 220	5044	58	5503	97	5603	76	5921	10	6001	168	6084	145
4478	93	5045	59	5507	86	5612	71	5922	10	6002	168	6085	149
4480	213	5046	62	5508	77, 85,	5614	72	5923	11, 56	6003	168	6086	149
4485	225	5048	62		220	5615	71	5924	10	6004	168	6087	149
4486	225	5054	16, 58	5510	86	5616	72	5925	10	6005	168	6088	149
4487	225	5055	59	5511	86	5617	71	5926	10	6006	168	6090	149
4489	225, 228	5056	59	5512	84	5622	76	5930	14	6007	168	6092	149
4490	225	5111	114	5513	85	5623	76	5931	14	6011	169	6093	148
4491	225	5112	114	5517	92	5624	77	5932	14	6013	169	6094	148
4492	225	5124	111, 112	5518	92	5627	71	5933	14	6017	169	6095	149
4493	224	5125	111, 112	5519	92	5630	106	5934	14	6018	169	6097	149
4494	225	5126	111, 112	5520	94	5631	106	5935	14	6019	170	6101	158
4495	227	5127	111, 113	5521	94	5656	72	5941	51	6020	169	6102	158
4496	227	5128	111, 113	5522	94	5657	72	5942	51	6024	169	6103	158
4497	227	5129	111, 113	5523	95	5710	73	5943	51	6029	170	6105	158
4498	227	5205	82	5524	94	5711	74	5944	51	6032	170	6108	159
4499	227	5206	82	5531	95	5712	74	5945	50	6039	172	6126	176, 177
4530	215	5211	79	5534	99, 170	5713	73	5946	50	6040	62	6127	176, 177
4540	217	5212	79	5539	95, 105	5858	19, 56	5947	50	6043	171	6131	157
4541	222	5232	79	5540	95	5859	19, 56	5948	50	6044	171	6133	157
4542	223	5241	81	5549	91	5860	19, 41	5949	50	6045	171	6134	157
4544	222	5242	81	5552	90	5861	19	5951	51	6046	173	6135	157
4545	222	5256	80	5554	90	5862	19	5952	51	6049	171	6142	177
4550	213	5262	81	5556	88	5863	17	5955	50	6050	171	6143	159
4560	215	5267	82	5557	88	5864	17	5960	49	6054	146	6144	159
4568	221	5270	80	5558	88	5867	11	5965	49	6055	147	6148	159
4583	224	5276	80	5560	91	5868	11	5966	49	6056	152	6154	159
4584	224	5277	80	5563	91	5875	18	5967	49	6060	167	6161	156
4704	229	5280	80	5565	77	5876	18	5968	49	6061	167	6162	156
4705	229	5281	80	5567	89	5883	18	5969	228	6066	166, 167	6167	156
4706	229	5292	81	5569	87	5884	18	5974	228	6067	166, 167	6168	156

Code No.	Page	Code No.	Page	Code No.	Page	Code No.	Page	Code No.	Page	Code No.	Page	Code No.	Page	Code No.	Page
6374	163	6536	153	6592	154, 196	6664	149	6825	151	6890	150	6951	152	10140	192, 193
6376	163	6537	153	6593	154, 196	6665	149	6826	151	6891	150	6952	152	10143	192, 193
6378	108, 174	6538	153	6594	154, 196	6667	149	6827	151	6892	150	6953	152	10146	192, 193
6380	175	6542	154, 196	6595	154, 196	6668	149	6829	151	6893	150	6954	152	10149	192, 193
6381	22	6543	154, 196	6596	154, 196	6669	149	6831	151	6894	150	6955	152	10152	192, 193
6383	108, 174	6544	154, 196	6597	154, 196	6670	149	6833	152	6895	150	6956	152	10155	192, 193
6385	108, 175	6545	154, 196	6599	154, 196	6675	149	6834	152	6899	150	6957	152	10158	192, 193
6386	108, 175	6546	154, 196	6601	183	6676	149	6835	152	6900	152	6958	152	10162	192, 193
6387	108, 175	6547	154, 196	6602	183	6678	22, 203	6836	152	6915	152	6959	152	10167	192, 193
6388	22	6548	154, 196	6605	153, 183	6679	22, 203	6837	152	6916	152	6960	152	10172	192, 193
6389	184	6549	154, 196	6606	153, 183	6689	125, 240	6838	152	6917	152	6961	152	10177	192, 193
6390	184	6550	154, 196	6607	153, 183	6694	200	6839	152	6918	152	6962	152	10182	192, 193
6400	170	6551	154, 196	6608	153, 183	6695	200	6840	152	6919	152	6963	152	10237	192, 193
6401	62, 170	6552	154, 196	6609	153, 183	6697	202	6841	152	6920	152	6964	152	10240	192, 193
6460	170	6555	154, 196	6610	153, 183	6699	202	6842	152	6921	152	6965	152	10243	192, 193
6461	170	6556	154, 196	6611	153, 183	6701	162	6845	152	6922	152	6967	152	10246	192, 193
6494	184	6557	154, 196	6616	149	6702	162	6847	152	6923	152	6968	152	10249	192, 193
6495	184	6558	154, 196	6618	149	6735	162	6848	152	6924	152	6970	152	10252	192, 193
6496	184	6561	154, 196	6619	149	6736	162	6850	151	6925	152	6971	152	10255	192, 193
6497	184	6562	154, 196	6625	149	6737	162	6851	151	6926	152	6972	152	10258	192, 193
6506	155	6563	154, 196	6626	149	6738	162	6853	151	6928	152	6974	152	10262	192, 193
6507	155	6564	154, 196	6627	149	6739	162	6865	150	6929	152	6975	152	10267	192, 193
6508	154	6565	154, 196	6628	149	6740	162	6866	150	6930	152	6977	152	10272	192, 193
6509	154	6566	154, 196	6629	149	6742	160	6868	150	6931	152	6980	152	10277	192, 193
6511	154	6567	154, 196	6630	149	6745	161	6869	150	6932	152	6982	152	10282	192, 193
6512	154	6568	154, 196	6631	149	6746	161	6870	150	6933	152	6985	152	14137	192, 193
6513	154	6569	154, 196	6632	149	6747	161	6871	150	6934	152	6990	152	14140	192, 193
6514	154	6570	154, 196	6634	149	6748	161	6873	150	6935	152	6992	152	14143	192, 193
6515	154	6571	154, 196	6636	149	6751	160	6874	150	6936	152	8255	164	14146	192, 193
6517	154	6572	154, 196	6637	149	6752	161	6875	150	6937	152	8261	164	14149	192, 193
6518	154	6573	154, 196	6638	149	6753	161	6876	150	6938	152	8281	164	14152	192, 193
6519	154	6574	154, 196	6640	149	6754	161	6878	150	6939	152	8282	164	14155	192, 193
6521	153	6575	154, 196	6642	149	6755	161	6879	150	6940	152	8283	164	14158	192, 193
6522	153	6576	154, 196	6643	149	6771	160	6880	150	6941	152	8287	164	14162	192, 193
6523	153	6577	154, 196	6644	149	6778	161	6881	150	6942	152	8288	164	14167	192, 193
6525	153	6578	154, 196	6645	149	6779	161	6882	150	6943	152	8289	164	14172	192, 193
6526	153	6579	154, 196	6646	149	6780	160	6883	150	6944	152	8818	165	14177	192, 193
6527	153	6584	154, 196	6648	149	6791	160	6884	150	6945	152	8825	165	14182	192, 193
6528	153	6585	154, 196	6649	149	6820	151	6885	150	6946	152	8826	165	14237	192, 193
6531	153	6586	154, 196	6650	149	6821	151	6886	150	6947	152	8827	165	14240	192, 193
6532	153	6588	154, 196	6651	149	6822	151	6887	150	6948	152	8933	132	14243	192, 193
6533	153	6589	154, 196	6662	202	6823	151	6888	150	6949	152	8934	127	14246	192, 193
6535	153	6591	154, 196	6663	202	6824	151	6889	150	6950	152	10137	192, 193	14249	192, 193

Code No.	Page	Code No.	Page	Code No.	Page	Code No.	Page	Code No.	Page	Code No.	Page	Code No.	Page		
14252	192, 193	15267	192, 193	15858	194, 195	16543	194, 195	16886	194, 195	18055	194, 195	18977	194, 195	702004	204
14255	192, 193	15272	192, 193	15862	194, 195	16546	194, 195	16895	194, 195	18058	194, 195	18982	194, 195	702005	204
14258	192, 193	15277	192, 193	15867	194, 195	16549	194, 195	17734	194, 195	18062	194, 195	19037	194, 195	705035	206
14262	192, 193	15282	192, 193	15872	194, 195	16552	194, 195	17737	194, 195	18067	194, 195	19040	194, 195	705070	206
14267	192, 193	15337	192, 193	15877	194, 195	16555	194, 195	17740	194, 195	18072	194, 195	19043	194, 195	705100	206
14272	192, 193	15340	192, 193	15882	194, 195	16558	194, 195	17743	194, 195	18077	194, 195	19046	194, 195	705200	206
14277	192, 193	15343	192, 193	15886	194, 195	16562	194, 195	17746	194, 195	18082	194, 195	19049	194, 195	706510	205
14282	192, 193	15346	192, 193	15895	194, 195	16567	194, 195	17749	194, 195	18086	194, 195	19052	194, 195	706511	205
14337	192, 193	15349	192, 193	16037	194, 195	16572	194, 195	17752	194, 195	18095	194, 195	19055	194, 195	706518	205
14340	192, 193	15352	192, 193	16039	194, 195	16577	194, 195	17755	194, 195	18249	194, 195	19058	194, 195	707001	206
14343	192, 193	15355	192, 193	16040	194, 195	16582	194, 195	17758	194, 195	18252	194, 195	19062	194, 195	707025	206
14346	192, 193	15358	192, 193	16043	194, 195	16586	194, 195	17762	194, 195	18255	194, 195	19067	194, 195	707030	205
14349	192, 193	15362	192, 193	16046	194, 195	16595	194, 195	17767	194, 195	18258	194, 195	19072	194, 195	707031	205
14352	192, 193	15367	192, 193	16049	194, 195	16737	194, 195	17772	194, 195	18262	194, 195	19077	194, 195	709035	206
14355	192, 193	15372	192, 193	16052	194, 195	16739	194, 195	17777	194, 195	18267	194, 195	19082	194, 195	709070	206
14358	192, 193	15377	192, 193	16055	194, 195	16740	194, 195	17782	194, 195	18272	194, 195	93296	29	709100	206
14362	192, 193	15382	192, 193	16058	194, 195	16743	194, 195	17849	194, 195	18277	194, 195	93304	44	709200	206
14367	192, 193	15437	192, 193	16062	194, 195	16746	194, 195	17852	194, 195	18282	194, 195	93307	45	719035	206
14372	192, 193	15449	192, 193	16067	194, 195	16749	194, 195	17855	194, 195	18449	194, 195	93310	30	719070	206
14377	192, 193	15458	192, 193	16072	194, 195	16752	194, 195	17858	194, 195	18452	194, 195	93313	30	719100	206
14382	192, 193	15467	192, 193	16077	194, 195	16755	194, 195	17862	194, 195	18455	194, 195	93314	30	719200	206
14437	192, 193	15477	192, 193	16082	194, 195	16758	194, 195	17867	194, 195	18458	194, 195	93318	45	750001	205
14440	192, 193	15737	192, 193	16086	194, 195	16762	194, 195	17872	194, 195	18462	194, 195	93324	30	750002	205
14443	192, 193	15740	192, 193	16095	194, 195	16767	194, 195	17877	194, 195	18467	194, 195	93325	44	750003	205
14446	192, 193	15743	192, 193	16237	194, 195	16772	194, 195	17882	194, 195	18472	194, 195	93339	30		
14449	192, 193	15746	192, 193	16239	194, 195	16777	194, 195	17937	194, 195	18477	194, 195	93391	45		
14452	192, 193	15749	192, 193	16240	194, 195	16782	194, 195	17939	194, 195	18482	194, 195	93392	45		
14455	192, 193	15752	192, 193	16243	194, 195	16786	194, 195	17940	194, 195	18849	194, 195	96008	163		
14458	192, 193	15755	192, 193	16246	194, 195	16795	194, 195	17943	194, 195	18852	194, 195	96653	186		
14462	192, 193	15758	192, 193	16249	194, 195	16837	194, 195	17946	194, 195	18855	194, 195	96654	186		
14467	192, 193	15762	192, 193	16252	194, 195	16839	194, 195	17949	194, 195	18858	194, 195	96655	186		
14472	192, 193	15767	192, 193	16255	194, 195	16840	194, 195	17952	194, 195	18862	194, 195	96656	186		
14477	192, 193	15772	192, 193	16258	194, 195	16843	194, 195	17955	194, 195	18867	194, 195	96657	186		
14482	192, 193	15777	192, 193	16262	194, 195	16846	194, 195	17958	194, 195	18872	194, 195	530809	130		
15237	192, 193	15782	192, 193	16267	194, 195	16849	194, 195	17962	194, 195	18877	194, 195	565108	130		
15240	192, 193	15837	194, 195	16272	194, 195	16852	194, 195	17967	194, 195	18882	194, 195	700001	205		
15243	192, 193	15839	194, 195	16277	194, 195	16855	194, 195	17972	194, 195	18949	194, 195	700010	205		
15246	192, 193	15840	194, 195	16282	194, 195	16858	194, 195	17977	194, 195	18952	194, 195	700020	205		
15249	192, 193	15843	194, 195	16286	194, 195	16862	194, 195	17982	194, 195	18955	194, 195	700030	205		
15252	192, 193	15846	194, 195	16295	194, 195	16867	194, 195	17986	194, 195	18958	194, 195	700060	205		
15255	192, 193	15849	194, 195	16537	194, 195	16872	194, 195	17995	194, 195	18962	194, 195	700100	205		
15258	192, 193	15852	194, 195	16539	194, 195	16877	194, 195	18049	194, 195	18967	194, 195	702001	204		
15262	192, 193	15855	194, 195	16540	194, 195	16882	194, 195	18052	194, 195	18972	194, 195	702002	204		

